

User Guide IM/CM/I-EN Rev. B

ControlMaster CM15

Universal process indicator 1/8 DIN



Power and productivity
for a better world™ **ABB**

The Company

We are an established world force in the design and manufacture of instrumentation for industrial process control, flow measurement, gas and liquid analysis and environmental applications.

As a part of ABB, a world leader in process automation technology, we offer customers application expertise, service and support worldwide.

We are committed to teamwork, high quality manufacturing, advanced technology and unrivalled service and support.

The quality, accuracy and performance of the Company's products result from over 100 years experience, combined with a continuous program of innovative design and development to incorporate the latest technology.

Basic Level

Refer to Section 6, page 21*

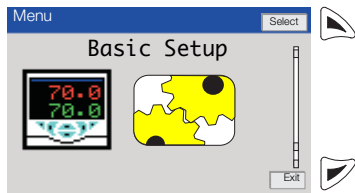

- Process Alarms
- Alarm Trip 1
- Alarm Trip 2
- Alarm Trip 3
- Alarm Trip 4
- Alarm Trip 5
- Alarm Trip 6
- Alarm Trip 7
- Alarm Trip 8

*Additional parameters may be enabled and displayed at Basic Setup level depending on the parameters selected at Advanced Level.

Advanced Level

Refer to Section 7.1, page 22

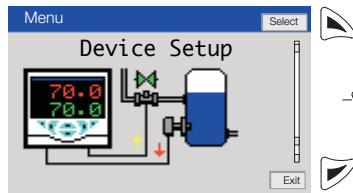

- Initial Setup
 - App. Template
 - Instrument Tag
 - Mains Frequency
 - Config Action
 - Level 1 Indicator
 - Custom Template
 - Stats. Reset Source
 - Reset to Defaults
- Security Setup
 - Basic Password
 - Advanced Password
 - Reset Passwords
- Custom Config
 - Off
 - Loop 1 PV
 - Volume 1
 - Loop 2 PV
 - Volume 2

Refer to Section 7.2, page 25

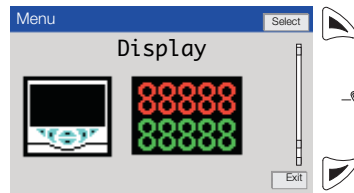

- Language
- Date & Time
 - Date Format
 - Time & Date
 - Daylight Saving
- Operator Templates
 - Page 1 (4) Template
- Operator Functions
 - Autoscroll
 - Soft Key Function
 - Alarm Ack. Enable
 - Totalizer Stop/Go
 - Totalizer Reset
 - Stats Reset Enable
- Customise Pages
 - Page Number
 - Template Type
 - Titlebar Tag
 - Parameters
 - Icons
 - Page Colors
- Settings
 - Brightness

Refer to Section 7.3, page 31

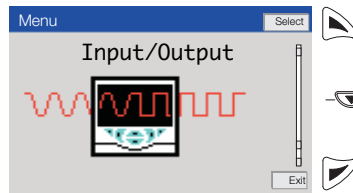

- Analog Inputs
 - Analog Input 1 (2)
- Analog Outputs
 - Analog Output 1 (2)
- Digital I/O
 - Digital IO 1 (2)
- Relays
 - Relay 1 (4)

Refer to Section 7.4, page 39

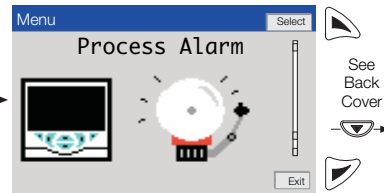

- Alarm 1 (8)
 - Type
 - Tag
 - Source
 - Trip
 - Hysteresis
 - Time Hysteresis
 - Display Enable
- Acknowledge Source
- Enable Source

See Back Cover

Note. When in Advanced Level (configuration) mode, press and hold the  key to return to the standard Operator page – see Section 5, page 17.

Contents

1 Safety	3	5 Operator Level Menus	17
1.1 Electrical Safety	3	5.1 Diagnostic Status Bar	18
1.2 Symbols	3	5.2 Diagnostic View	19
1.3 Health & Safety	4	5.3 Security Options	19
2 Introduction	5	5.4 Access Level	20
2.1 EC Directive 89/336/EEC	5	6 Basic Setup	21
2.2 End of Life Disposal	5	7 Advanced Level	22
3 Display, Icons and Keys	6	7.1 Device Setup	22
4 Installation	7	7.2 Display	25
4.1 Siting	7	7.3 Input/Output	31
4.2 Dimensions	8	7.4 Process Alarm	39
4.3 Mounting	9	7.5 Totalizer	42
4.4 Jumper Links for Relay Outputs	10	7.5.1 Calculating the Totalizer Count Rate Manually	45
4.4.1 Removing the Indicator from its Case	10	7.6 Functions	49
4.4.2 Resetting Jumper Links	11	7.7 Communication	59
4.5 Electrical Connections	12	7.8 Diagnostics	59
4.5.1 Analog Inputs	14	7.8.1 Diagnostic Messages	61
4.5.2 Frequency / Pulse Input	15	7.9 Device Info	63
4.5.3 Digital Input / Output	15		

8 Templates and Functionality	64	Appendix A – Digital and Analog Sources	76
8.1 Basic Templates	64	A.1 Digital Sources	76
8.1.1 Single Channel PV	64	A.2 Analog Sources	77
8.1.2 One PV / Totalizer	64		
8.1.3 One Channel Totalizer	65	Appendix B – Configuration Error Codes	78
8.1.4 Single Channel Level	65		
8.2 Dual Templates	66	Appendix C – Analog Input (Engineering) Units	81
8.2.1 Dual Channel PV	66		
8.2.2 Dual PV / Totalizer	66	Appendix D – Output Type Assignments	82
8.2.3 Dual Channel Totalizer	66		
8.2.4 Dual Channel Level	67		
9 PC Configuration	68		
10 Specification	69		

1 Safety

Information in this manual is intended only to assist our customers in the efficient operation of our equipment. Use of this manual for any other purpose is specifically prohibited and its contents are not to be reproduced in full or part without prior approval of the Technical Publications Department.





1.1 Electrical Safety





This equipment complies with the requirements of CEI / IEC 61010-1:2001-2 'Safety Requirements for Electrical Equipment for Measurement, Control and Laboratory Use' and complies with US NEC 500, NIST and OSHA.

If the equipment is used in a manner NOT specified by the Company, the protection provided by the equipment may be impaired.

1.2 Symbols

One or more of the following symbols may appear on the equipment labelling:

	Warning – Refer to the manual for instructions
	Caution – Risk of electric shock
	Functional earth (ground) terminal
	Protective earth (ground) terminal

	Direct current supply only
	Alternating current supply only
	Both direct and alternating current supply
	The equipment is protected through double insulation

1.3 Health & Safety

Health and Safety

To ensure that our products are safe and without risk to health, the following points must be noted:

- The relevant sections of these instructions must be read carefully before proceeding.
- Warning labels on containers and packages must be observed.
- Installation, operation, maintenance and servicing must only be carried out by suitably trained personnel and in accordance with the information given.
- Normal safety precautions must be taken to avoid the possibility of an accident occurring when operating in conditions of high pressure and / or temperature.

Safety advice concerning the use of the equipment described in this manual or any relevant hazard data sheets (where applicable) may be obtained from the Company, together with servicing and spares information.

2 Introduction

This manual provides details for the ControlMaster CM15 ($\frac{1}{8}$ DIN) indicator.

Note.

- Read all relevant sections of this guide before configuring the system or modifying system parameters.
- Install and use associated equipment in accordance with the relevant national and local standards.
- System configuration must be carried out only by users or personnel with approved access rights (user privileges).

2.1 EC Directive 89/336/EEC

In order to meet the requirements of the EC Directive 89/336/EEC for EMC regulations, this product must not be used in a non-industrial environment.

2.2 End of Life Disposal

Indicators with Standard functionality and above contain a small lithium battery that must be removed and disposed of responsibly in accordance with local environmental regulations.

Indicators with Basic functionality do not contain any substance that causes undue harm to the environment and must be disposed of in accordance with the Directive on Waste Electrical and Electronic Equipment (WEEE). They must not be disposed of in Municipal Waste Collection.

3 Display, Icons and Keys

An example of an Operator Page is shown in Fig. 3.1.

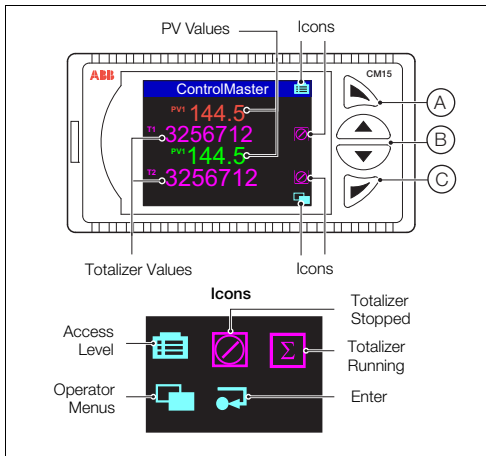

Fig. 3.1 ControlMaster CM15 Operator Page and Keys

(A)	Navigation key (upper) / programmable <i>Soft Key</i> – see page 26.
(B)	Up / Down keys – navigate up / down menu items and increase / decrease displayed values
(C)	Navigation key (lower) / <i>Operator Level</i> access key.

Table 3.1 CM15 Front Panel Key Functions

Note. When a *Soft Key* option is assigned to the (upper) navigation key (A), the *Advanced Level* (see page 22) must be accessed using the (lower) *Operator Level* access key (C).

4 Installation

4.1 Siting

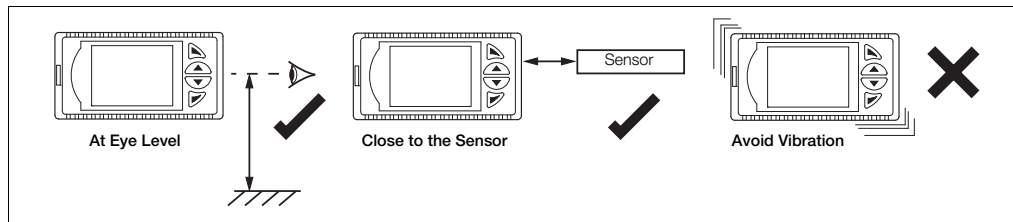

Fig. 4.1 Siting

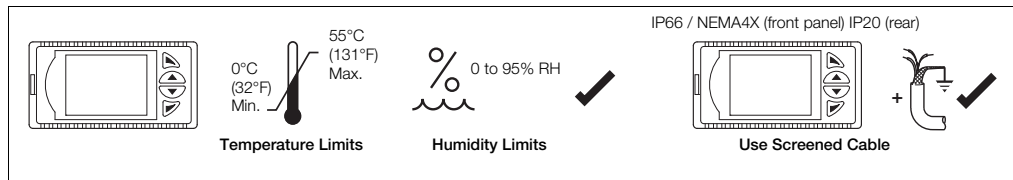

Fig. 4.2 Environmental Requirements

4.2 Dimensions

Dimensions in mm (in.)

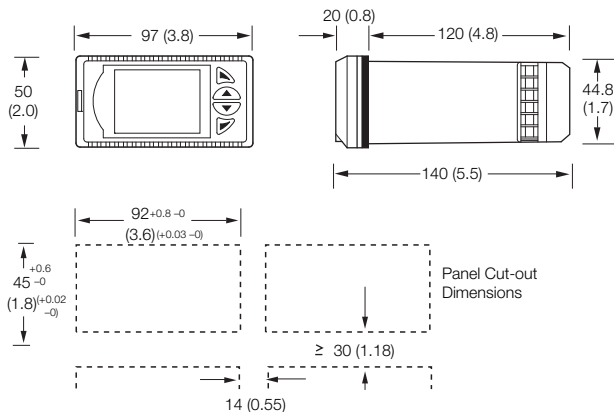

Fig. 4.3 ControlMaster CM15 Dimensions

4.3 Mounting

ControlMaster is designed for panel mounting. For NEMA4X protection, a panel thickness of 2.5 mm (0.1 in.) is required.

To panel-mount the indicator:

1. Cut a hole of the correct size for the indicator in the panel (see page 8 for dimensions).
2. Insert the indicator into the panel cut-out.

Referring to Fig. 4.4:

3. Position the upper panel clamp (A) at the top front of the case against the panel.
4. Locate the panel clamp anchor (B) in slot (C).
5. Tighten the panel clamp anchor screw (D) until panel clamp (A) is secured against the panel.

Caution. Do not overtighten the screw.

6. Repeat steps 3 to 5 to fit the lower panel clamp (E) and panel clamp anchor (F).

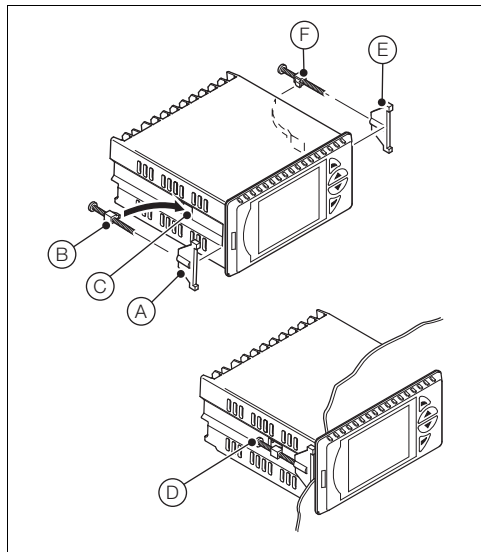

Fig. 4.4 Mounting Details

4.4 Jumper Links for Relay Outputs

The factory-set default for relay action is N/O.

4.4.1 Removing the Indicator from its Case

The indicator's inner assembly must be removed from its case to access the relay contact jumper links.

Referring to Fig. 4.5:

1. Insert the bezel release tool (A) (supplied) into the front panel slot (B) to the left of the function keys.
2. Press the bezel release tool (A) fully in and then left (C) until the shoulder on the tool engages with the notch behind the indicator front plate.
3. Pull the bezel release tool (A) to withdraw the inner assembly from the case (D).

Note. If the bezel release tool is mislaid, 2 small flat-headed screwdrivers (4 mm [0.15 in.]) can be used as alternative tools, one inserted into the front panel slot and the second for leverage in the notch behind the indicator front plate. The notch is the only area that can be used as a leverage point – do not attempt to lever the front panel from any other area.

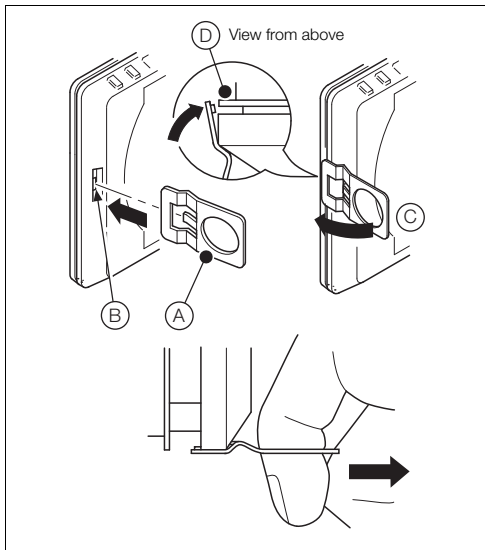

Fig. 4.5 Removing the Indicator from the Case

4.4.2 Resetting Jumper Links

Note. The factory-set default for all jumper links is N/O.

1. The links associated with the relay outputs are shown in Fig. 4.6.
2. If necessary, move the link to select the relay action required (N/O or N/C).

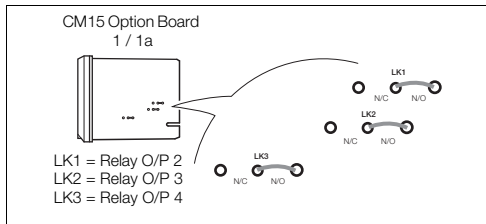

Fig. 4.6 Jumper Links for Relay Outputs

4.5 Electrical Connections

Warning.

- The indicator is not fitted with a switch therefore a disconnecting device such as a switch or circuit breaker conforming to local safety standards must be fitted to the final installation.
- It must be mounted in close proximity to the controller within easy reach of the operator and must be marked clearly as the disconnection device for the indicator.
- Remove all power from supply, relay and any powered control circuits and high common mode voltages before accessing or making any connections.
- Use cable appropriate for the load currents. The terminals accept cables from 18 to 14 AWG (0.8 to 2.5mm²).
- Always route signal leads and power cables separately, preferably in earthed (grounded) metal conduit.
- It is strongly recommended that screened cable is used for signal inputs and relay connections.
- The instrument conforms to Mains Power Input Overvoltage Category 2, Pollution Degree 2 (EN601010-1). (This equipment is protected through double insulation – Class II.)
- Analog / digital inputs and outputs, transmitter power supply and DC power supply are SELV (Safety Extra Low Voltage) circuits.
- All connections to secondary circuits must have basic insulation.
- After installation, there must be no access to live parts, e.g. terminals.
- Terminals for external circuits are for use only with equipment with no accessible live parts.
- If the controller is used in a manner not specified by the Company, the protection provided by the equipment may be impaired.
- All equipment connected to the indicator's terminals must comply with local safety standards (IEC 60950, EN601010-1).

Note. Terminal screws must be tightened to a torque of 0.1 Nm (0.9 lbf/in.).

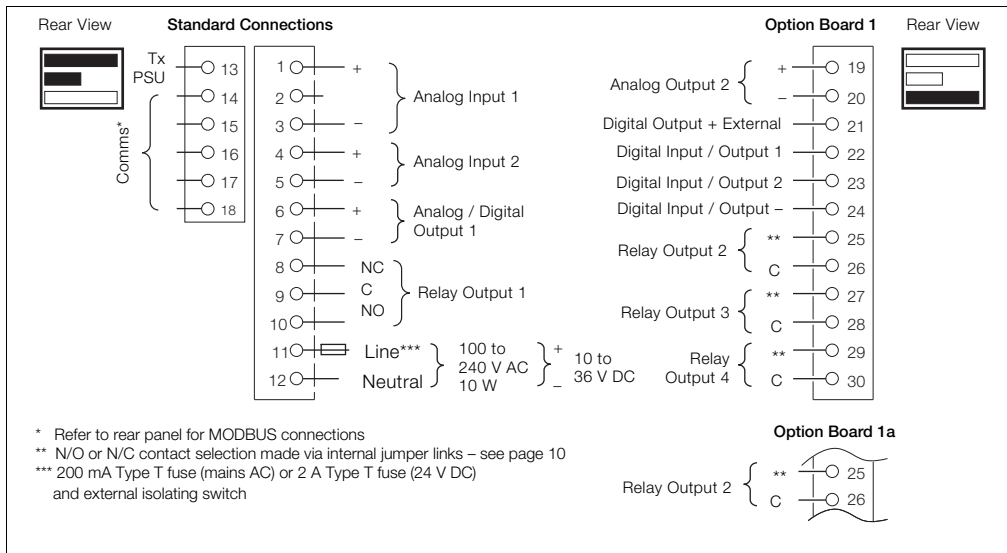

Fig. 4.7 ControlMaster CM15 Electrical Connections

4.5.1 Analog Inputs

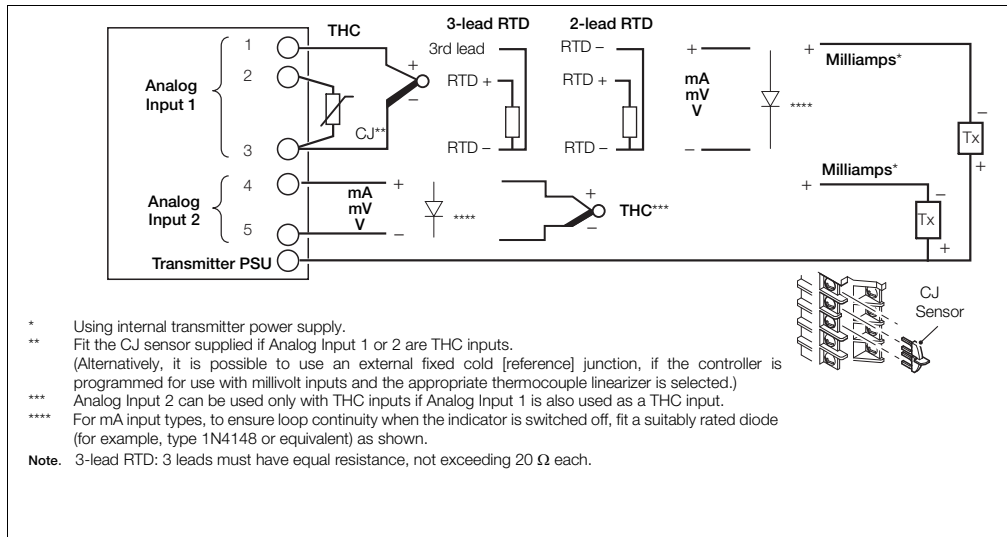

Fig. 4.8 Standard Analog Inputs (1 and 2)

4.5.2 Frequency / Pulse Input

Note. This input is designed primarily for use with flowmeters.

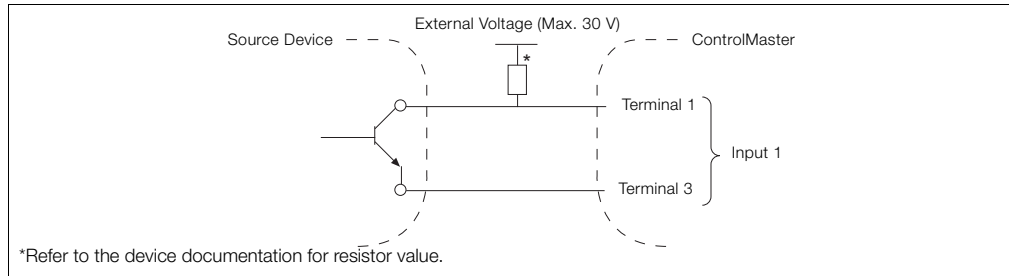

Fig. 4.9 Frequency / Pulse Input

4.5.3 Digital Input / Output

Note. Open collector digital input / output connections are shown in Fig. 4.10 – see page 74 for Digital Input / Output type options.

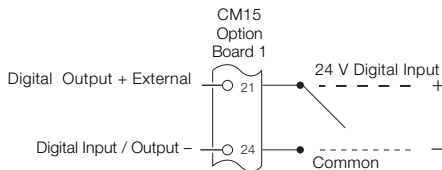
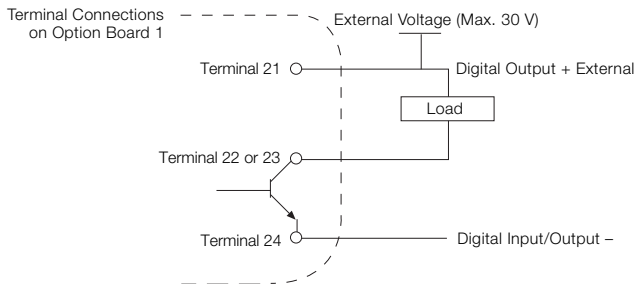
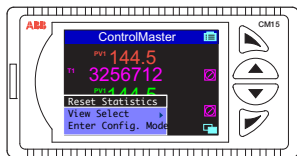







Fig. 4.10 Open Collector Digital Input / Output Connections

5 Operator Level Menus



Operator level menus are used to reset statistics, select the view and to enter *Basic* and *Advanced* modes (via the *Access Level*).

To access *Operator Level* menus:

1. From the *Operator Page*, press  to view the available menus.
2. Use the  /  keys to scroll through the menus and menu options.
3. Press  to expand menu levels and to select menu options or press  to return to the previous menu.

Reset Statistics	Resets current statistics.
View Select	Switches the view to an <i>Operator Page</i> or the <i>Diagnostic View</i> .
Enter Config. Level	Displays the <i>Access Level</i> selection views – see Section 5.4, page 20 for security options.

Table 5.1 *Operator Level Menu Functions*

5.1 Diagnostic Status Bar

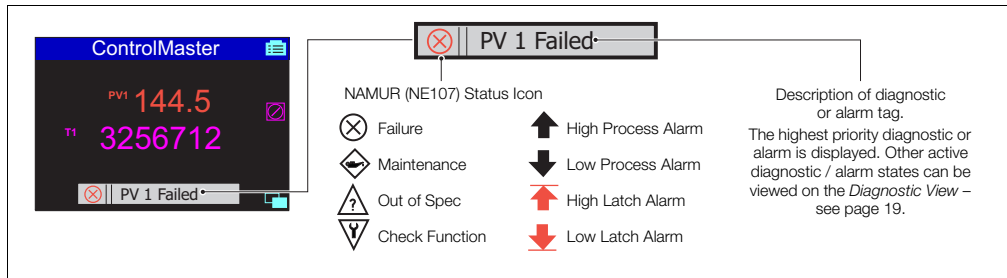

Fig. 5.1 ControlMaster Diagnostic Status Bar

5.2 Diagnostic View

The *Diagnostic View* is selected from the *Operator / View Select* menu. All currently active diagnostic alarm states are displayed in the *Diagnostic View*.

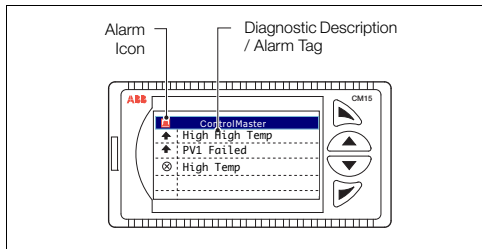

Fig. 5.2 ControlMaster Diagnostic View

5.3 Security Options

Passwords can be set to enable secure end-user access at 2 levels: *Basic* and *Advanced*. The *Service* level is password-protected at the factory and reserved for factory use only. Passwords are set, changed or restored to their default settings at the *Device Setup / Security Setup* parameter – see page 24.

Note. When the indicator is powered-up for the first time the Basic and Advanced levels can be accessed without password protection. Protected access to these levels must be allocated on-site as required.

5.4 Access Level

Level	Access
Logout	Displayed after <i>Basic</i> or <i>Advanced</i> level are accessed. Logs the user out of <i>Basic</i> or <i>Advanced</i> level. If passwords are set, a password must be entered to access these levels again after selecting <i>Logout</i> .
Read Only	Enables all parameter settings to be viewed
Basic Setup	Enables access to the Basic level and adjustment of alarm trip points.
Advanced	Enables configuration access to all parameters.
Service	Reserved for use by authorized service personnel.

Table 5.2 Access Levels

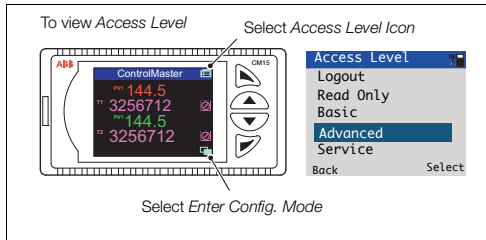
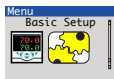

Fig. 5.3 Access Level

Note. A 5-minute time-out period enables a user to return to the *Operator* page and re-access the previous menu (displayed at exit) without re-entering the password. For periods over 5-minutes (or if Logout is selected), a password must be re-entered to access protected levels.

6 Basic Setup



Provides access to basic alarm setup parameters.

Note. Additional parameters may be displayed at *Basic Setup* level - these are dependent on the parameters selected at *Advanced Level*.

Process Alarms

Alarm Trip 1 (8)

The alarm trip level in engineering units – see *Process Alarm* (page 39) for parameter details.

7 Advanced Level

7.1 Device Setup

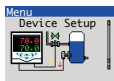

Provides access to standard setup parameters to determine the type of indication required. Also provides the ability to create non-standard configurations for special application requirements.

Initial Setup

App. Template

Application templates enable configurations for particular applications to be created as simply as possible. Select the appropriate template before configuring any other parameters. When a template is selected, the indicator assumes the preset form for that template. The inputs and function blocks are soft-wired automatically to perform the selected function.

Note. See Section 8, page 64 for available templates.

Instrument Tag

A 16-character alphanumeric tag, displayed in the title bar on *Operator* pages.

Mains Frequency

Used to set the internal filters to reduce mains power frequency interference.

...Device Setup / ...Initial Setup

Config Action	The <i>Config Action</i> parameter is used to determine how the indicator and indicator outputs behave when the <i>Advanced</i> level is entered – see page 22.
<i>Continue</i>	The indicator continues to operate as in Operator level. Outputs continue to operate as normal.
<i>Hold</i>	Digital, relay and analog outputs are held at their value / state when <i>Configuration</i> mode is entered. When the <i>Advanced</i> level is exited, the indicator returns to the <i>pre-Configuration</i> mode of operation.
<i>Inactive</i>	Analog outputs are set to 0 mA. Relays de-energized, digital outputs inactive.
Level 1 (2) Indicator*	Note. Applicable to level applications only.
<i>Specific Gravity</i>	Value of the specific gravity currently applied to the process variable.
<i>Volume Constant</i>	The constant used to calculate the volume (maximum value 999.9).
<i>Volume Units</i>	The unit of measure used to calculate the volume.
<i>Volume DPs</i>	The number of decimal places required (maximum of 4).
Custom Template	If this parameter is enabled, it enables the internal function blocks to be re-linked to create custom configurations for special application requirements. These sources are configured in <i>Device Setup / Custom Config</i> – see page 24.

*See Section 8.2.4, page 67 for examples of volume calculations.

...Device Setup / ...Initial Setup

Stats. Reset Source	Sets the digital source signal used to reset the statistics.
Reset to Defaults	Resets all configuration parameters to their default values.
Security Setup	2 Security access levels are provided, each protected by a password of up to 6 alphanumeric characters. Note. Passwords are not set at the factory and must be entered by the end user(s).
Basic Password	<i>Basic</i> level provides access to the <i>Basic</i> level.
Advanced Password	Provides access to Advanced configuration parameters – see Section 7, page 22.
Reset Passwords	Resets all passwords to factory values.
Custom Config	
<i>Loop 1 PV</i>	Sets the source for the (<i>Loop 1</i>) process variable.
<i>Volume 1</i>	Sets the source for <i>Volume 1</i> .
<i>Loop 2 PV</i>	Sets the source for the (<i>Loop 2</i>) process variable.
<i>Volume 2</i>	Sets the source for <i>Volume 2</i> .

7.2 Display

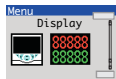

Used to setup the display language, operator page template and format and type of information displayed.

Language	Selects the language on the indicator's local display.
Operator Templates	Enables up to 4 operator pages to be configured to suit the application requirements.
Page 1 (4) Template	<p>The operator template type. The functions available in each template type are displayed as abbreviations, for example:</p> <p><i>PV & TOT</i></p> <p>Key to abbreviations:</p> <ul style="list-style-type: none"> ■ PV = process variable ■ TOT = totalizer ■ VOL = volume

...Display

Operator Functions

Autoscroll	When enabled (<i>On</i>), operator pages are scrolled continuously at intervals of 10 seconds per page.
Soft Key Function	Assigns a dedicated function to the Navigation key (right) – see page 6.
<i>Configuration</i>	Displays the <i>Access Level</i> enabling selection of configuration levels.
<i>Scroll View</i>	Scrolls through each available <i>Operator</i> view.
<i>Alarm Ack.</i>	Acknowledges all active unacknowledged alarms.
<i>Toggle Signal</i>	Provides a source that toggles between 2 states – can be assigned to outputs or used to select sources.
<i>Edge Signal</i>	Provides an edge-triggered source that is active on key press. Can be assigned to outputs or select sources
Alarm Ack. Enable	Turns on / off the ability to acknowledge alarms from the front panel.
Totalizer Stop/Go	Starts / stops the totalizer.
Totalizer Reset	Resets the totalizer.
Stats Reset Enable	Turns on / off the ability to reset statistics from the front panel.

...Display

Settings	Adjusts display settings to suit local environmental conditions.
Brightness	Increases / Decreases the display brightness.
Date & Time	Sets the date format, local time and date and daylight saving start / end times.
Date Format	Sets the indicator's date format.
Date & Time	Sets the indicator's time and date.
Daylight Saving	Sets daylight saving parameters.
DS Region	Note. Daylight saving is disabled when <i>DS Region</i> is <i>Off</i> .
<i>Europe</i>	Standard daylight saving start and end times are selected automatically for Europe.
<i>USA</i>	Standard daylight saving start and end times are selected automatically for USA.
<i>Custom</i>	Select to create custom daylight saving start / end times for regions other than Europe or USA and to enable <i>Daylight Start Time</i> and <i>Daylight End Time</i> parameters.
DS Start Time	Selected from 1-hour increments.
DS End Time	Note. Displayed only when the <i>DS Region</i> sub-parameter is <i>Custom</i> .

...Display / ...Date & Time / ...Daylight Saving

DS Start Occur	The day within the month that daylight starts / ends – for example, to set daylight saving to start (or end) on the second Monday of the selected month, select <i>Second</i> .
DS End Occur	
DS Start Day	The day of the month daylight saving starts / ends – the <i>Daylight Start / End Occur</i> parameters must be valid within the month for the selected day.
DS End Day	
DS Start Month	The month daylight saving starts / ends.
DS End Month	

Customise Pages

The contents and appearance of each *Operator Page* (see page 17) can be customized to meet particular user requirements.

Page Number	Selects the <i>Operator Page</i> (1 to 4) to be customized.
Template Type	Selects one of the standard operator page templates.

Template codes:

A = Analog value, T = Totalizer value, S = State value (see page 29)

A (Style 1)	A,A (Style 1)	A,A,T	A,A,A,A (Style 1)
T	A,T (Style 1)	A,T,T	A,A,A,T
	T,T (Style 1)		A,A,T,T
	T,T (Style 2)		A,T,A,T

Titlebar Tag	A user-programmable, 16-character alphanumeric tag.
--------------	---

...Display / ...Customise Pages

Parameters

Parameter Number	1 to 4 (depending on the <i>Template Type</i> selected).				
Type	Enables some parameter types to be modified to provide more flexibility in the display formats available: <ul style="list-style-type: none"> ■ Parameters set as <i>Totalizer value</i> by the <i>Template Type</i> can be changed to analog or state parameters. ■ Parameters set as <i>State value</i> by the <i>Template Type</i> can be changed to an analog parameter. 				
Source	Selects the signal to be displayed.				
Color	Selects the color to be used to display this parameter. Color codes:				
	Black	Red	Yellow	Green	Cyan
	Blue	Magenta	White	Grey	
	Dark Cyan	Dark Magenta	Dark Grey	Dark Yellow	Dark Green
	Dark Blue	Dark Red			
	Theme RGB*	Theme RYG**			
	*Theme RGB:		**Theme RYG		
	■ State 0 tag is shown in red.		State 0 tag is shown in red.		
	■ State 1 tag is shown in green.		State 1 tag is shown in yellow.		
	■ State 2 tag is shown in blue.		State 2 tag is shown in green.		

...Display / ...Customise Pages / ...Parameters

Tag	A user-programmable, 3-character alphanumeric tag used to identify each parameter.
State 0 (1, 2) Tag	A user-programmable, 8-character alphanumeric tag displayed when the state of the selected parameter has a value of 0 (1, 2).
<hr/>	
Icons	Used to configure up to 8 icons (with some custom display templates it is not possible to display all 8 icons).
Icon Number	Selects the icon number to be configured.
Type	Selects the type of icon to be displayed.
Color	Selects the color of the selected icon used on the display.
<hr/>	
Page Colors	Used to define <i>Operator Page</i> colors and titlebar colors.
Background Color	Selects the background color of the <i>Operator Page</i> – see page 17.
Titlebar Color	Selects the background color of the titlebar.
Title Tag Color	Selects the color of the titlebar tag.
Softkey Color	Selects the color for the <i>Soft Key</i> icons.

7.3 Input/Output

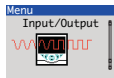

Enables analog and digital inputs / outputs and relays to be configured.

Analog Inputs

Analog Input 1 (2)*

Input Type

Input types comprise: *Millivolts, Milliamps, Volts, Resistance (Ohms), RTD, Thermocouple, Digital volt-free, 24V Digital, Freq. Input, Pulse Input.*

Additional *Input Type* comments:

Digital Volt Free

Acts as a digital input.

Freq. Input

Sets the maximum frequency and equivalent flow rate in the engineering range 0 to 6000 Hz. (A frequency of up to 6 KHz can be used to create an analog value.)

Pulse Input

This parameter counts pulses and is recommended only for use with electromagnetic flowmeters.

*Analog Input 2: *Freq Input, Pulse Input* and *Resistance* not available. A *Thermocouple* input type can be set only if the first input is set to *Thermocouple*.

... Input/Output / ...Analog Input 1 (2)

Elect. Low

Sets the required electrical range.

Note. Applicable only to *Millivolts, Milliamps, Volts and Ohms*.

Linear Inputs	Standard Analog Input	Accuracy (% of Reading)
Millivolts	0 to 150 mV	0.1 % or $\pm 20 \mu\text{V}$
Milliamps	0 to 50 mA	0.2 % or $\pm 4 \mu\text{V}$
Volts	0 to 25 V	0.2 % or $\pm 1 \text{ mV}$
Resistance Ω (low)	0 to 550 Ω	0.2 % or $\pm 0.1 \Omega$
Resistance Ω (high)	0 to 10 k Ω	0.1 % or $\pm 0.5 \Omega$

Elect. High

Sets the required electrical range.

Note. Applicable only to *Millivolts, Milliamps, Volts and Freq. Input*.

Linearizer

Selects the linearizer type required to condition the input signal.

Notes. For thermocouple applications using an external fixed cold junction, set *Input Type* to *Millivolts* (see page 31) and select the appropriate linearizer type.

Not applicable for *Pulse Input, Digital volt-free, 24V Digital* parameters – see page 31.

... Input/Output / ...Analog Input 1 (2)

Eng Units	The selected units are used by the linearizer and displayed in the <i>Operator</i> pages. Not applicable for: <i>Pulse Input</i> , <i>Digital volt-free</i> and <i>24V Digital</i> parameters. <i>Thermocouple</i> and <i>RTD</i> inputs (see page 31) are restricted to <i>deg C</i> , <i>deg F</i> , <i>Kelvin</i> – see Appendix C, page 81 for analog input units.
Eng. Dps	Engineering decimal places – selects the resolution required to be displayed for the input value.
Eng. Low Eng High	Specifies the engineering low (minimum) / high (maximum) value. For example, for an electrical input range of 4.0 to 20.0 mA, representing a pressure range of 50 to 250 bar, set the <i>Eng Low</i> value to 50.0 and the <i>Eng High</i> value to 250.0. Not applicable for <i>Pulse Input</i> – see page 31.
Pulse Units	Selects the unit of measure for the pulse input type.
Pulse / Unit	Sets the number of pulses required to represent 1 pulse unit (as set above). For example, if <i>Pulse Units</i> = Kl and <i>Pulse / Unit</i> = 10.00000000, each pulse represents 0.1 Kl, 10 pulses = 1 Kl.

... Input/Output / ...Analog Input 1 (2)

Broken Sensor	If an input failure occurs, the input value can be configured to drive in a set direction.
<i>None</i>	No action taken.
<i>Automatic</i>	If the value of failed input is below <i>Eng Low</i> (see page 33), the input value is driven to minimum downscale value; otherwise it is driven to the maximum upscale value.
<i>Upscale</i>	The input is driven to the maximum upscale value.
<i>Downscale</i>	The input is driven to the minimum downscale value.
Filter Time	The input is averaged over the time set.
Fault Detect	Sets a tolerance level (in % of engineering range) to allow for deviation of the input signal above or below the engineering range before an input failure is detected.
Zero Adjustment Span Adjustment	These 2 parameters enable fine tuning of the inputs to eliminate system errors. Apply a known input value and adjust until the required input value is displayed. Normally, <i>Zero Adjustment</i> is used with input values close to <i>Eng Low</i> (perform adjustment by applying an offset to the reading) and <i>Span Adjustment</i> is used with values close to <i>Eng High</i> (perform adjustment by applying a multiplier to the reading).
Reset Zero/Span	Resets the selected <i>Zero / Span Adjustment</i> parameter.

...Input/Output

Analog Outputs	The analog outputs can be configured to retransmit any analog value and have a configurable range from 0 to 24 mA. Output 1 can also be configured to function as a digital output.
Analog Output 1 (2)	Note. Analog Output 2 is available only if <i>Option Board 1</i> is fitted – see page 13.
Output Type	Selects the analog or digital output (applicable only to <i>Analog Output 1</i>).
Source	Selects the parameter to be assigned to the output – see Appendix A, page 76 for description of sources.
Elect. Low*	The current output required when the source value is equal to the <i>Eng Low</i> value – see page 33.
Elect. High*	The current output required when the source value is equal to the <i>Eng High</i> value – see page 33.

*Not applicable if *Output Type* is *Digital* or *Source* is *None*.

...Input/Output / ...Analog Outputs / ...Analog Output 1 (2)

Auto Eng Range*	If enabled (<i>On</i>) the <i>Eng High</i> and <i>Eng Low</i> values for the output are set automatically to the engineering range values of the source.
Eng Low*	The minimum engineering range output value.
Eng High*	The maximum engineering range output value.
Polarity**	Sets the polarity of the output signal. If <i>Negative</i> , the output is energized when source is inactive. If <i>Positive</i> , the output is energized when source is active.

*Not applicable if *Output Type* is *Digital* or *Source* is *None*.

**Not applicable if *Output Type* is *Analog* or *Source* is *None*.

...Input/Output

Digital I/O**Digital IO 1 (2)**

Type	Sets the <i>Digital IO</i> to operate as an output or an input.
<i>Off</i>	No action taken.
<i>Output</i>	The <i>Digital IO</i> operates as an output.
<i>Volt Free</i>	High input detected when volt free switch across input is closed.
<i>24 Volt</i>	Digital input low < 5V, high > 11V (maximum input 30 V).
<i>TTL</i>	Digital input low < 0.8V, high > 2V.
Output Source	Selects the digital signal to be assigned to the output – see Appendix A.1, page 76 for description of sources.

...Input/Output / ...Digital I/O / ...Digital IO 1 (2)**Polarity**

Sets the polarity of the output signal.

*Positive*For an output, the output is high if the source is active.
For an input, the input is active if a high signal is detected.*Negative*For an output the output is high if the source is inactive.
For an input, the input is active if a low signal is detected.

Relays

Relay 1 (4)

Source

Selects the digital signal to be assigned to the relay – see Appendix A.1, page 76 for description of sources.

Polarity

Sets the polarity of the relay.

Positive

The relay is energized If the source is active.

Negative

The relay is energized If the source is inactive.

7.4 Process Alarm



Used to configure up to 8 independent process alarms.

Process Alarm

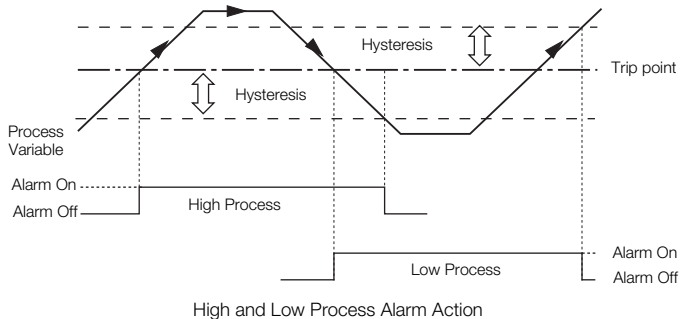

...Process Alarm

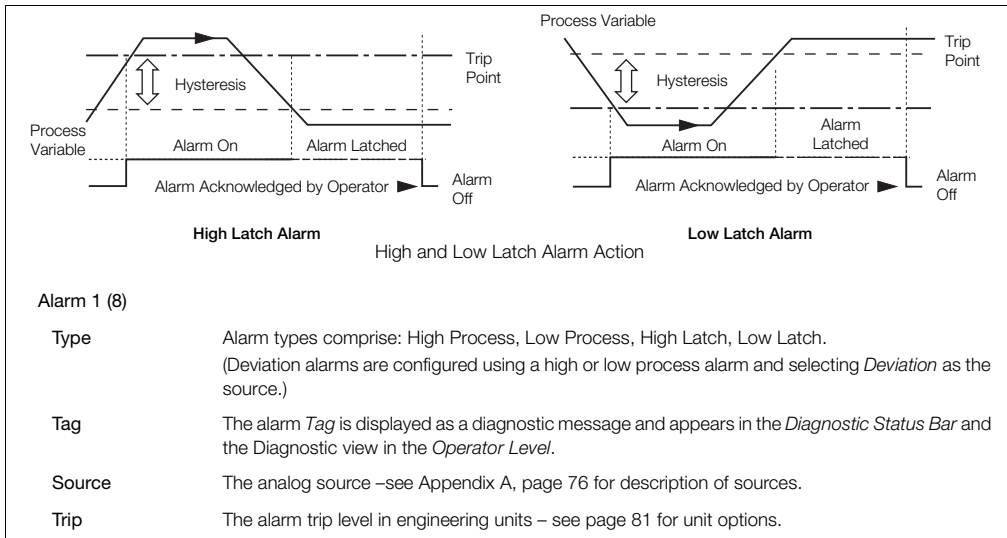

...Process Alarm / ... Alarm 1 (8)

Hysteresis	Hysteresis trip level in engineering units. Activated at the alarm trip level but deactivated only when the process variable has moved into the safe region by an amount equal to the hysteresis value – see Process Alarm examples on page 39.
Time Hysteresis	If an alarm trip value is exceeded, the alarm does not become active until the <i>Time Hysteresis</i> value has expired. If the signal goes out of the alarm condition before the <i>Time Hysteresis</i> has expired, the hysteresis timer is reset.
Display Enable	Enables an alarm to be used for control purposes without it appearing as an active alarm state in the <i>Operator</i> level or <i>Diagnostic</i> view.
Acknowledge Source	The source required to acknowledge all active alarms. Acknowledge occurs on rising edge of the digital signal – see Appendix A, page 76 for description of sources.
Enable Source	The source required to enable alarms. If <i>the</i> source is <i>None</i> , alarms are always enabled –see Appendix A, page 76 for description of sources.



7.5 Totalizer

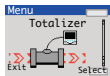

Two 9-digit totalizers are provided. These can be configured independently to totalize any analog or digital signal. Four modes of operation are provided.

Where possible, the count rate is calculated automatically according to source units, totalizer units and engineering range.

Totalizer 1 (2)

Mode

<i>Off</i>	Totalizer disabled.
<i>Analog</i>	Totalization of any analog signal.
<i>Digital</i>	Counting of low / high transitions of any digital signal (for example, digital input or alarm) minimum pulse duration >125 ms.
<i>Frequency</i>	Totalization of a frequency input on Analog input 1.
<i>Pulse</i>	Totalization of a pulse input on Analog input 1.

Source

The input to be totalized. The inputs available for selection are dependent on the *Mode* selected. Not displayed for frequency and pulse inputs – see Appendix A, page 76 for description of sources.

...Totalizer

Count Direction*Up*

Totalizer value increases with time.

Down

Totalizer value decreases with time.

Units

(Totalizer) units are used along with the source's units and engineering range to calculate the count rate automatically (where possible). Where the units or mode required do not allow this, the count rate must be calculated manually – see Section 7.5.1, page 45.

Count Rate

In *Analog* mode, this represents the counts (in volume units) / second when the source is at its engineering high value.

In *Digital*, *Frequency* and *Pulse* mode (see page 42) this represents the number of totalizer (volume) units / pulse.

Cutoff

The lowest input value (in engineering units) the totalizer stops counting at.

Stop Go Source

The source required to stop and start the totalizer. Selection is made on the rising edge:

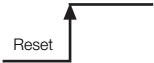

...Totalizer

Total DP's	Selects the number of decimal places displayed on the totalizer value.
Preset Count	The value the totalizer counts from and the value applied when the totalizer is reset.
Predet Count	The value the totalizer stops or wraps.
Intermediate Count	The value the intermediate count digital signal is activated. This can be used as an alarm threshold to indicate when the <i>Predet Count</i> value is about to be reached.
Wrap Enable	If set to <i>On</i> the total is reset automatically to the <i>Preset Count</i> value once the <i>Predet Count</i> value is reached. The wrap digital signal is made active for a duration of 1 second. If set to <i>Off</i> the count stops when the <i>Predet Count</i> value is reached. The wrap digital signal is made active until the Totalizer is reset.
Reset Source	The source required to reset the totalizer value. Selection is made on the rising edge:  <p>The diagram shows a horizontal line representing a signal level. From the left, the line goes down to a lower level, then up to a higher level, and then continues horizontally to the right. An arrow points to the upward-sloping portion of the line, which is labeled 'Reset'.</p>
Reset Days	Selects the day or days to reset the totalizer.
Reset Hour	Selects the hour to reset the totalizer (the totalizer is always reset exactly on the hour).

7.5.1 Calculating the Totalizer Count Rate Manually

Analog Mode

$$\text{Count Rate} = \frac{\text{Eng Hi (of source)} \times \text{volume unit conversion}}{\text{time unit conversion}}$$

Example:

Eng Hi = 2500 l/m. Totalizer required to increment in m^3 .

Volume unit conversion: 1 l = 0.001 m^3 .

Source time units = minutes, count rate units = seconds.

Time unit conversion: 1 min = 60 s.

$$\text{Count Rate} = \frac{2500 \times 0.001}{60} = 0.04167 \text{ m}^3/\text{s}$$

If the input source is at a fixed rate of 2500 l/min, the totalizer increments at $0.04167 \text{ m}^3/\text{s}$.

If the input source is reduced to a fixed rate of 1250 l/min, the totalizer increments at:

$$\frac{1250}{2500} \times 0.04167 = 0.0208 \text{ m}^3/\text{s}$$

Digital Mode

The count rate setting determines the scaling of the digital input pulses.

For example, with a Count Rate = 100 totalizer units / pulse, 5 digital input pulses increment the totalizer from 0 to 500 in 100 unit steps:

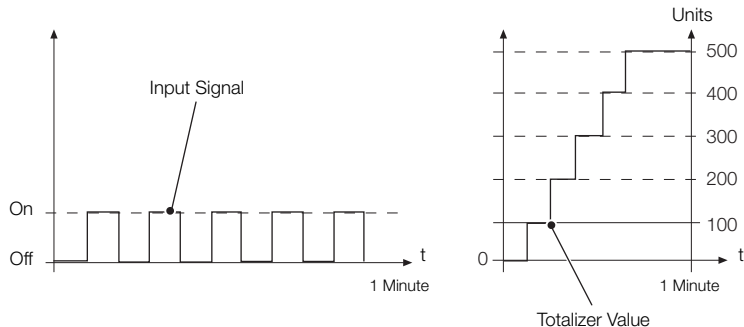

Frequency Mode

$$\text{Count Rate} = \frac{\text{Eng Hi (of source)} \times \text{volume unit conversion} \times \text{pulse duration}}{\text{time unit conversion}}$$

Example:

Eng Hi = 6000 l/m. Frequency input fullscale (Electrical High) = 500 Hz.

Totalizer required to increment in m^3 .

Volume unit conversion: 1 l = 0.001 m^3 .

Source time units = minutes, count rate units = seconds.

Time unit conversion: 1 min = 60 s

$$\text{Pulse Duration} = \frac{1}{\text{Analog input 1 Electrical High (Hz)}}$$

$$\text{Count Rate} = \frac{6000 \times 0.001 \times 0.002}{60} = 0.0002 \text{ m}^3/\text{s}$$

If the input source is at a fixed rate of 6000 l/min (500 Hz) the totalizer increments at $0.0002 \text{ m}^3/\text{s}$.

If the input source is reduced to a fixed rate of 3000 l/min (250 Hz), the totalizer increments at:

$$\frac{3000}{6000} \times 0.0002 = 0.0001 \text{ m}^3.$$

Pulse Mode

$$\text{Count Rate} = \frac{\text{Volume unit conversion}}{\text{Pulse / Unit}}$$

For example:

Pulse / Unit = 50, Pulse Units = l, Totalizer required to increment in m^3 .

Volume unit conversion: 1 l = 0.001 m^3 .

$$\text{Count Rate} = \frac{0.001}{50} = 0.00002 \text{ m}^3/\text{pulse}$$

7.6 Functions



Contains parameters for setting up the math block(s), logic equations and timer functions within the indicator.

Logic Equations

Up to 8 logic equations can be configured. Each can combine up to 8 operands (digital signals) with 7 operators. The elements of each equation are calculated sequentially. Operand 1, Operator 1 and Operand 2 are evaluated first. The result is combined with Operator 2 and Operand 3. This result is then combined with the next operator and operand and so on to the end of the equation.

Note. If any of the operand sources are invalid (for example, an alarm that is not configured), the logic equation output state is zero and invalid.

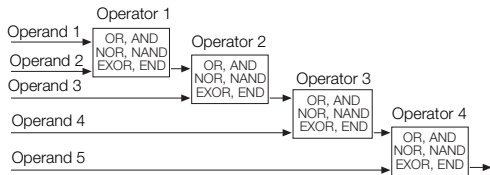

Key:

- OR* Output is 1 if either or both inputs are 1; output is 0 if both inputs are 0
- AND Output is 1 if both inputs are 1; output is 0 if either input is 0
- NOR Output is 0 if either or both inputs are 1; output is 1 if both inputs are 0
- NAND Output is 0 if both inputs are 1; output is 1 if either input is 0
- EXOR Output is 0 if both inputs are 0 or both inputs are 1; output is 1 if one input is 1 and the other is 0
- END Terminates the equation.

*2 Logic equations are required to perform an exclusive OR of 3 inputs

...Functions / Logic Equations

Equation Number	Selects the logic equation to be configured.
Operand 1 (8)	See Appendix A, page 76 for description of sources.
Invert 1 (8)	Logically inverts (applies NOT function to) the digital signal. For example, if the digital signal assigned to the operand has a state of '1' it is inverted to a state of '0' before being applied to the equation.
Operator1 (7)	Selects the <i>Operator</i> type: OR, AND, NOR, NAND, EXOR, END. Select END if no more elements are required.
Math Blocks	Up to 8 math blocks can be configured. Each block can be configured as 1 of 6 different types (see <i>Block Type</i> below). The resulting analog value can be used as a source for other function blocks, for example, <i>Process Variable</i> in the <i>Custom Config</i> parameter – see page 24.
Math Block Number	The math block number (1 to 8).
Block Type	Selects the type of math block required.

...Functions / ...Math Blocks / ...Block Type

Equation

Enables an equation with up to 4 operands and 3 operators to be created. The operands can be assigned to any analog or digital signal (see Appendix A, page 76). Digital signals have a value of either '0' or '1'. With the exception of the Median operator, the equation is processed in a strict left to right order, with no operator precedence.

The result of a math block can be used as the operand in another math block, enabling more complex math equations to be constructed.

The math blocks are processed in ascending order; Math block 1 is processed first, then Math Block 2, then 3 to 8:

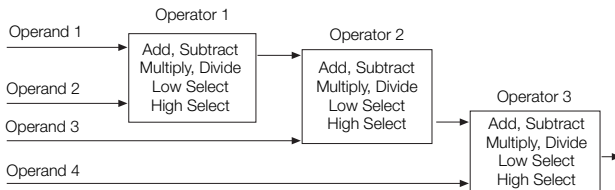

...Functions / ...Math Blocks / ...Block Type

Real Time Average Calculates the average value of a parameter over a user-configurable duration. The output of the math block is updated at the end of the set duration only. A reset signal can be configured to restart the calculation of the average value.

The average value is stored in case of power failure. If the duration of the power failure is longer than the *Average Duration* (see page 54), the math block output value is set to zero.

Max Hold The math block output represents the highest value of the signal since it was reset.

Min Hold The math block output represents the lowest value of the signal since it was reset.

Multiplexer Enables 1 of 2 analog signals or constant values to be selected using a digital signal.

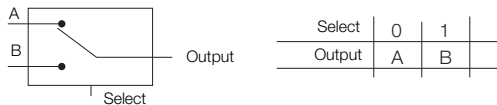

Square Root Calculates the square root of the selected sources value. If the input is less than 0, the output is set to zero and the math block output state set to invalid.

...Functions / ...Math Blocks / ...Block Type

Equation Setup:

Source 1 (2)	The source of the first operand in the equation (any analog or digital signal or user-defined constant).
Source 1 (2) Constant	Sets the constant value to be used. Note. Applicable only if <i>Source 1</i> is assigned to one of the Constants.
Operator 1 (3)	
<i>End</i>	Terminates the equation.
<i>Add</i>	} Standard arithmetic functions.
<i>Subtract</i>	
<i>Multiply</i>	
<i>Divide</i>	
<i>Low Select</i> <i>High Select</i>	Result is the lower / higher of the 2 operands.
<i>Median</i>	If <i>Median</i> operators are used the median value calculated is dependent on the number of operands. The median value of 2 operands is their mean value. The median value of 3 operands is the value of the middle operand when the operands are sorted into ascending order. The median value of 4 operands is the mean value of the 2 nd and 3 rd operands when the 4 operands are sorted into ascending order.

...Functions / ...Math Blocks / ...Block Type

Real Time Average Setup:

Source 1 (RTA Source)	Selects the source for <i>Real Time Average</i> calculation – see Appendix A, page 76 for description of sources.
Reset Source	Selects the digital source required to reset the internal accumulative value and timer. This does not change the immediate output of the math block but restarts the calculation of the next average value – see Appendix A.1, page 76 for digital sources.
Average Duration	Sets the time duration the average is calculated over. The output value of the math block is updated at this rate.

Max Hold / Min Hold Setup:

Source 1	Selects the source for maximum / minimum value calculation – see Appendix A, page 76 for description of sources.
Reset Source	Select the digital signal to be used to reset the maximum or minimum value.

...Functions / ...Math Blocks / ...Block Type

Multiplexer Setup:

Source 1	Selects the source (any analog signal [see page 76] or user-defined constant) for the first input into the multiplexer.
Source 1 Constant	Sets the constant value to be used. Note. Applicable only if <i>Source 1</i> is assigned to one of the constants
Source 2	Select the source for the second input into the multiplexer.
Source 2 Constant	Sets the constant value to be used. Note. Applicable only if <i>Source 1</i> is assigned to one of the Constants
Mux Selector	Select the digital signal to be used to switch between the 2 multiplexer inputs. '0' selects first input (Mux A Src); '1' selects second input (Mux B Src).

Square Root Setup:

Source 1	Selects the source of the parameter that requires square root to be applied – see Appendix A, page 76 for description of sources.
----------	---

...Functions / ...Math Blocks

Setup for **All Math Block Types**:

Eng. Dps	Selects the number of decimal places (resolution) displayed for the math block result.
Eng. Low	Selects the engineering range low / high value for display and calculation of proportional band.
Eng. High	If the math block result exceeds the <i>Eng High</i> or <i>Eng Low</i> value by more than 10%, the math block fail state is set and its output is determined by the <i>Fault Action</i> (see below).
Eng Units	The selected units are displayed in the operator pages – see Appendix C, page 81 for description of engineering units.
Fault Action	The value returned when the math block fails can be configured.
<i>None</i>	Failed calculated value is used as math block output.
<i>Automatic</i>	If the failed calculated output value is below zero the output is driven to its minimum value. If the failed calculated output value is above zero the output is driven to its maximum value.
<i>Upscale</i>	If the math block fails, its output is driven to its maximum value.
<i>Downscale</i>	If the math block fails, its output is driven to its minimum value.

...Functions

<p>Linearizer 1 (2)</p> <p>Source 1 (2)</p> <p>Lin 1 (2)</p> <p>Breakpoints</p> <p> <i>Breakpoint</i></p> <p> <i>X</i></p> <p> <i>Y</i></p>	<p>A 20-breakpoint (custom) linearizer. Custom linearizers can be applied to any analog input by selecting them as the linearizer type for that input – see page 31. The engineering range and units of the input source are assigned to the custom linearizer output.</p> <p>Selects the input source to be linearized – see page 76 for description of sources.</p> <p>Set X and Y values as a % of the engineering range input source.</p> <p>Selects the breakpoint to be configured.</p> <p>X is input to the linearizer expressed as a % of the electrical range.</p> <p>Y is output expressed as a % of the engineering range.</p>	
<p>Delay Timer 1 (2)</p> <hr/> <p>Source 1 (2)</p> <p>Delay Time</p> <p>On Time</p>	<p>Two delay timers are provided. Each is triggered by the rising edge of its assigned source. An internal timer is started and, when the timer reaches the set <i>Delay Time</i>, its output goes high for the <i>On Time</i> that is configured. After the delay time is triggered it ignores further transitions of the source input until the end of this delay timer cycle (until end of <i>On Time</i>).</p> <p>The source signal used to trigger the delay timer. Trigger occurs on rising edge of the signal – see Appendix A, page 76 for description of sources.</p> <p>The delay (in seconds) between the trigger received and the output of the delay timer going high.</p> <p>The amount of time (in seconds) the delay timer output is held in the high state.</p>	

...Functions

Real Time Alarms	2 Independent real-time alarms can be configured for activation on particular days and times for a set duration.
Real Time Alarm 1 (2)	Sets the days, month, time and duration the alarm is activated.
<i>Monday (to Sunday)</i>	
<i>Month enable</i>	When enabled (<i>On</i>), activates the alarm on the 1 st day of each month.
<i>Every hour</i>	When enabled (<i>On</i>), activates the alarm every hour.
<i>On hour</i>	Sets the hour the alarm is activated – not applicable if <i>Every hour</i> is enabled.
<i>On minute</i>	Set the minutes past the hour the alarm is activated.
<i>Duration</i>	Set the duration the alarm is active.
<i>Display enable</i>	If disabled (<i>Off</i>), the alarm state does not appear in the operator level diagnostics window or the alarm log
<i>Tag</i>	A 16-character alphanumeric diagnostic message displayed in the <i>Diagnostic Status Bar</i> and the <i>Diagnostic View</i> in the <i>Operator Level</i> – see Section 5, page 17.

7.7 Communication



Used to setup communications parameters for the MODBUS / Ethernet communication protocols – see separate User Guide (IM/CM/C-EN).

Note. Only 1 communications option can be fitted per indicator.

7.8 Diagnostics

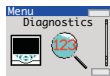





Used to view diagnostic data – see Section 7.8.1, page 61 for description of diagnostic messages and recommended corrective action(s).

Diagnostic history

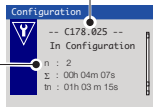
Displays a log of the diagnostic messages generated by the indicator. Each diagnostic condition has a classification code conforming to NAMUR NE107.

- n = Number of instances of this diagnostic condition
 Σ = Total time spent in this diagnostic condition
 tn = Time since the last instance of this diagnostic condition



-  M = Maintenance
-  S = Out of Spec
-  C = Check Function
-  F = Failure

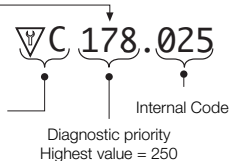

...Diagnostics

Source Analysis

Analog Sources	Enables the current value of any analog source to be viewed.
Analog Source	Selects the analog signal to be viewed – see Section A.2, page 77.
View Value	Displays the value of the analog signal selected.
Digital Sources	Enables the current state of any digital source to be viewed.
Digital Source	Selects the digital signal to be viewed – see Section A.1, page 76.
View State	Displays the state of the digital signal selected.
Invalid Sources	Select edit to display any invalid analog or digital sources that are used in the configuration. Reasons for invalid sources include: <ul style="list-style-type: none">■ Hardware not fitted■ Software not fitted■ Digital I/O configured as wrong type■ Alarms not configured■ Math, logic, timer or custom linearizer not configured

7.8.1 Diagnostic Messages

Icon	Number / Message	Possible Cause	Suggested Action
⊗	F250.00 PV 1 Failed	Problem with Input assigned to Loop 1 (2) PV. Broken sensor leads, defective input source or input signal out of permitted range.	Check wiring. Check input source. Check if input signal is outside permitted limits.
⊗	F248.001 PV 2 Failed	Problem with Input assigned to Loop 1 (2) PV. Broken sensor leads, defective input source or input signal out of permitted range.	Check wiring. Check input source. Check if input signal is outside permitted limits.
⊗	F222.014 CJ 1 Failed	Error in Cold junction measurement associated with AIN1 (AIN3). Wiring fault or defective sensor.	Check cold junction device is correctly fitted. Ensure I/P 2 is turned off. Replace CJ sensor.
⊗	F220.015 CJ 2 Failed	Error in Cold junction measurement associated with AIN1 (AIN3). Wiring fault or defective sensor.	Check cold junction device is correctly fitted. Replace CJ sensor.
⊗	F216.016 NV Error Proc Bd	Failure of non-volatile memory on processor display board or permanent corruption of its data.	Check all configuration parameters and correct any errors. Acknowledge error. If problem persists contact local service organization.
⊗	F214.017 NV Error Main Bd	Failure of non-volatile memory on main board or permanent corruption of its data.	Check calibration of AIN1, AIN2 and AO1. Recalibrate if necessary. Acknowledge error. If problem persists contact local service organization.

Table 7.1 Diagnostic Messages

Icon	Number / Message	Possible Cause	Suggested Action
⊗	F212.018 NV Error Opt Bd 1	Failure of non-volatile memory on option board 1 or permanent corruption of its data.	Check calibration of AO2, AIN 3 & AIN4 (CM50 only). Recalibrate If necessary. Acknowledge error. If problem persists contact local service organization.
⊗	F210.019 NV Error Opt Bd 2	Failure of non-volatile memory on option board 2 or permanent corruption of its data.	Check calibration of AO2, AIN 3 & AIN4. Recalibrate If necessary. Acknowledge error. If problem persists contact local service organization.
⊗	F208.020 NV Error Comm Bd	Failure of non-volatile memory on communications board or permanent corruption of its data.	Acknowledge error. Check communications board is correctly identified by device. If problem persists contact local service organization.
⊗	F206.021 NV Error SW Key 1	Failure of non-volatile memory on Software key 1 or permanent corruption of its data.	Acknowledge error. Check software key functionality is enabled. If problem persists contact local service organization.
⊗	F204.022 NV Error SW Key 2	Failure of non-volatile memory on Software key 1 or permanent corruption of its data.	Acknowledge error. Check software key functionality is enabled. If problem persists contact local service organization.

Table 7.1 Diagnostic Messages (Continued)

7.9 Device Info



Used to display read-only factory-set parameters for the indicator.

Instrument Type	The indicator's model number (for example, CM15).
I/O Build	The input / output (I/O) configuration.
No. Analog Inputs	The number of analog inputs available.
No. Analog Outputs	The number of analog outputs available.
No. Relays	The number of relays available.
No. Digital I/O	The number of digital inputs / outputs available.
Functionality	The current functional setting of the indicator (for example, <i>Single Channel PV</i>).
Serial No.	The factory serial number.
Hardware Revision	The indicator's hardware version number.
Software Revision	The indicator's software version number.

8 Templates and Functionality

ControlMaster CM15 indicators fitted without a software key have basic templates and functionality. ControlMaster CM15 indicators fitted with 2 software keys have dual templates and functionality.

Notes.

- Input assignments can be changed in Device Setup / Custom Config – see page 24.
- Output assignments can be changed in Input / Output configuration – see page 31.

8.1 Basic Templates

8.1.1 Single Channel PV

This template enables the indication of a single PV.

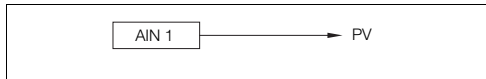

8.1.2 One PV / Totalizer

This template enables a single PV along with totalization of that PV, providing the ability to show either the Batch Total (default) or Secure Total.

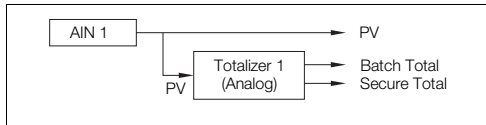

8.1.3 One Channel Totalizer

This template enables totalization from a digital signal, to provide a counter function.

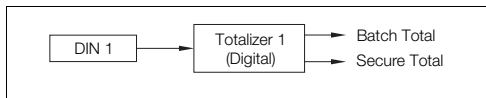

8.1.4 Single Channel Level

This template adds level functionality to the Single Channel template. This consists of applying a Specific Gravity calculation to the PV to provide the level of a liquid within a vessel.

A volume calculation can also be applied to the level to provide the volume contained within a vessel.

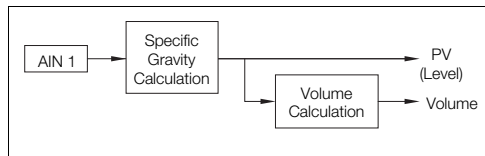

8.2 Dual Templates

8.2.1 Dual Channel PV

This template enables all the functions available on the Single PV indication but allows 2 separate PVs to be displayed on the Indicator.

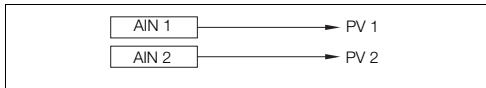

8.2.2 Dual PV / Totalizer

This template enables 2 separate PVs along with separate totalization of those PVs, providing the ability to show both the Batch Totals or Secure Totals.

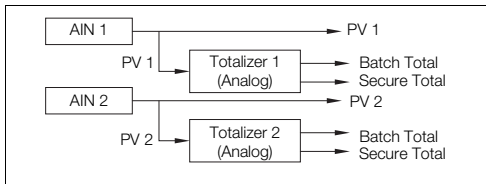

8.2.3 Dual Channel Totalizer

This template enables 2 channels of totalization from separate digital signals.

The primary function of this template is to provide 2 independent counters.

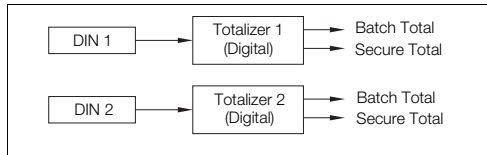

8.2.4 Dual Channel Level

This template adds Level functionality to the Dual Channel PV template.

For each channel, this consists of applying a Specific Gravity calculation to the PV to provide the level of a liquid within a vessel.

A volume calculation can also be applied to the level to provide the volume contained within a vessel.

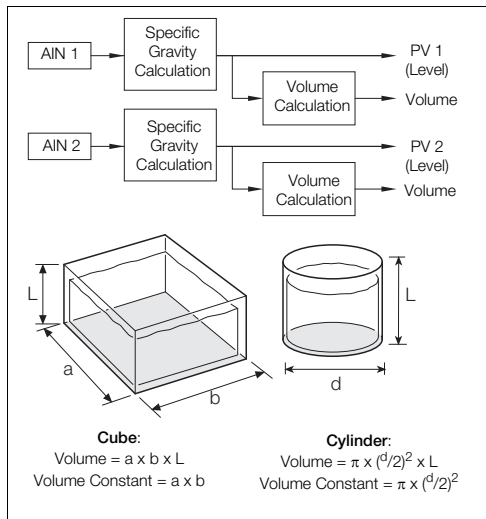

9 PC Configuration

In addition to local configuration via the front panel keys, the indicator can be configured from a PC via the infrared port. The infrared port is activated when *Advanced* level is accessed. For further information contact your sales representative.

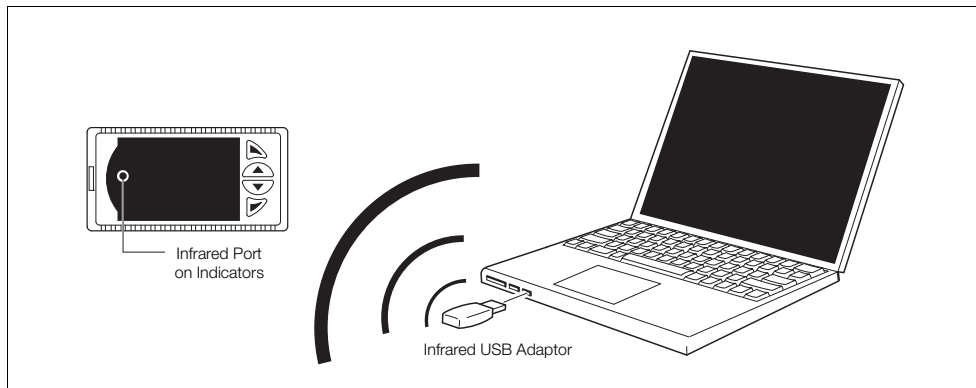

Fig. 9.1 PC Configuration via Infrared Port

10 Specification

Operation

Display

Color 1/4 VGA TFT, liquid crystal display (LCD) with built-in backlight

Language

English, German, French, Italian and Spanish

Operator keypad

4 Tactile membrane keys

Security

Password protection

Basic / Advanced user-assigned password protection (not set at factory)

Standard functions

Control strategies

Basic templates	Single PV indication
	Single PV indication + totalizer Counter
	Single PV indication + level
Dual templates	Dual PV indication
	Dual PV indication + totalizer
	Dual Counter
	Dual PV indication + level

Process alarms

Number	8
Types	high / low process
	high / low latch
Hysteresis	level and time
Alarm enable	enable / disable individual alarms via a digital signal

Acknowledgement

Via front panel keys or digital signals.

Real-time alarms*

Number	2
Programmable	time day duration

Maths blocks*

Number	8
Operators	+ , - , x , / Average, Maximum, Minimum High / Low / Median Select Square root Multiplexer

Delay timers*

Number	2
Programmable	delay duration

Logic equations*

Number	8
Elements	15 per equation
Operators	OR, AND, NOR, NAND, NOT, EXOR

Custom linearizer*

Number	2
Elements	20 breakpoints

*Indicator fitted with standard function key only

Analog inputs**Universal process inputs**

Number	1 standard
Type	voltage current resistance 3-Wire RTD thermocouple digital volt-free digital 24 V frequency

Non-universal process inputs

Number	1 standard
Type	voltage current thermocouple (only if universal input is configured as thermocouple) digital volt-free digital 24 V

Thermocouple types

B, E, J, K, L, N, R, S, T

Resistance thermometer

PT100

Other linearizations \sqrt{x} , $x^{3/2}$, $x^{5/2}$, custom linearization**Digital filter**

Programmable 0 to 60 s

Display range

-99999 to 999999

Update rate

125 ms

Common mode noise rejection>120 dB at 50 / 60 Hz with 300 Ω imbalance resistance**Normal (series) mode noise rejection**

>60 dB at 50 / 60 Hz

CJC rejection ratio

0.05 °C / °C change in ambient temperature

Temperature stability0.02 % / °C or 2 μV / °C (1 μV / °F)**Long term (input) drift**<0.1 % of reading of 10 μV annually**Input impedance**>10 M Ω (millivolts input)10 Ω (mA input)

Inputs

Thermocouple	Maximum Range °C (°F)	Accuracy (% of reading)
B [#]	-18 to 1800 (0 to 3270)	0.1 % or ± 2 °C (3.6 °F) (above 200 °C [392 °F]) ⁺
E	-100 to 900 (-140 to 1650)	0.1 % or ± 0.5 °C (0.9 °F)
J	-100 to 900 (-140 to 1650)	0.1 % or ± 0.5 °C (0.9 °F)
K	-100 to 1300 (-140 to 2350)	0.1 % or ± 0.5 °C (0.9 °F)
L	-100 to 900 (-140 to 1650)	0.1 % or ± 1.5 °C (2.7 °F)
N	-200 to 1300 (-325 to 2350)	0.1 % or ± 0.5 °C (0.9 °F)
R [#]	-18 to 1700 (0 to 3000)	0.1 % or ± 1 °C (1.8 °F) (above 300 °C [540 °F])
S [#]	-18 to 1700 (0 to 3000)	0.1 % or ± 1 °C (1.8 °F) (above 200 °C [392 °F])
T [#]	-250 to 300 (-400 to 550)	0.1 % or ± 0.5 °C (0.9 °F) (above -150 °C [-238 °F])

[#] For B, R, S and T thermocouples, accuracy is not guaranteed below the value stated.

RTD	Maximum Range °C (°F)	Accuracy (% of reading)
PT100	-200 to 600 (-325 to 1100)	0.1 % or ± 0.5 °C (0.9 °F)

Linear Inputs	Standard Analog Input	Accuracy (% of reading)
Millivolts	0 to 150 mV	0.1 % or ± 20 μ V
Milliamps	0 to 50 mA	0.2 % or ± 4 μ A
Volts	0 to 25 V	0.2 % or ± 1 mV
Resistance Ω (low)	0 to 550 Ω	0.2 % or ± 0.1 Ω
Resistance Ω (high)	0 to 10 k Ω	0.1 % or ± 0.5 Ω
Sample Interval	125 ms per sample	

Digital Inputs	
Type	Volt-free or 24 V
Minimum pulse duration	Single inputs configured – 250 ms Both inputs configured as analog or digital – 500 ms

Frequency input*	
Frequency range	0 to 6000 Hz
1-signal	15 to 30 V
0-signal	–3 to 5 V

*For use with devices with open collector outputs

Outputs

Controls / retransmission outputs

Number	2 (1 standard, 1 optional)
Isolation	galvanically isolated from the rest of the circuitry, 500 V for 1 minute
Analog range	0 to 20 mA Programmable
Load	750 Ω Max.
Accuracy	0.25 % of output or $\pm 10 \mu\text{VA}$

Relays

Number	4 (1 standard, 3 optional)
Type	standard with changeover contacts. optional contacts selectable as N/O or N/C (by jumper)

Contact ratings

Relay 1:	5 A, 240 V
Relays 2, 3, 4:	5A, 240 V (max. ambient 40 °C (104 °F))
Relays 2, 3, 4:	2A, 240 V (max. ambient 55 °C (131 °F))

Update rate	125 ms
-------------	--------

Digital input / output

Number	2 (optional)
Type	User-programmable as input or output <ul style="list-style-type: none">■ Input<ul style="list-style-type: none">– volt-free or 24 V DC– 1-signal: 15 to 30 V– 0-signal: -3 to 5 V– conforms to 61131-2■ Output<ul style="list-style-type: none">– open collector output– 30 V, 100 mA max. switched– conforms to 61131-2
Update rate	125 ms

2-Wire transmitter power supply

Number	1 (standard)
Voltage	24 V DC
Drive	2 loops, 45 mA max.

Communications

For MODBUS and Ethernet communications see separate User Guide (IM/CM/C-EN).

Infrared port

Baud rate	up to 115 kBaud
Distance	up to 1 m
Functions	firmware upgrade, configuration upload /download

EMC**Emissions & immunity**

Meets requirements of IEC61326 for an Industrial Environment

Environmental**Operating temperature range**

-0 to 55 °C (32 to 131 °F)*

Operating humidity range

5 to 95 % RH (non-condensing)

Storage temperature range

-20 to 70 °C (-4 to 158 °F)

Enclosure sealing

Front face	IP66 / NEMA4X
Rest of enclosure	IP20

*Restrictions may apply, refer to relay specification.

Safety

Approvals and Certifications

EN61010-1
cULus

General safety

Overvoltage Class III on mains, Class II on inputs and outputs
Pollution category 2
Insulation category 2

Isolation (to inputs)

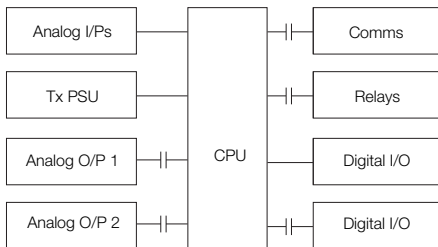

Key

—||— = Isolation

Electrical

Supply ranges

100 to 240 V AC $\pm 10\%$ (90 V min. to 265 V max.) 50 / 60 Hz
10 to 36 V DC (optional)

Power consumption

10 W max.

Power interruption protection

No effect for interrupts of up to 60 ms

Physical

Size

50 x 97 x 140 mm (2.0 x 3.8 x 5.5 in.)

Weight

0.38 kg (0.84 lb) approx. (unpacked)

Panel cutout

45 x 92 mm (1.8 x 3.6 in.) 120 mm (4.8 in.) behind panel

Case material

Glass-filled polycarbonate

DS/CM15-EN Rev. D

Appendix A – Digital and Analog Sources

Note. Numbers in brackets indicate additional parameters, for example, 'Alarm 1 (8) Ack. State indicates that 8 *Alarm Ack. State* parameters are available.

A.1 Digital Sources

Source Name	Description [Comment]
Alarm 1 (8) Ack. State	Acknowledged alarm = 0 Unacknowledged alarm = 1
Alarm 1 (8) State	Alarm state
Anlg IP 1 (2) Fail	Analog input failure (active when the signal detected at the analog input is outside the fault detect level specified during configuration).
AO1 (2) Loop Break	Analog output
Delay Timer 1 (2)	Delay timer state
IP 1 (2) Digital State	Input 1 (2) digital state
Linearizer 1 (2) Fail	Custom linearizer failure

Source Name	Description [Comment]
Logic Equation 1 (8)	Logic equation result
Math Block 1 (8) Fail	Maths failure
RTA 1 (2) State	Real time alarm state
Softkey Toggle	Front panel soft key toggles the source's state.
Softkey Edge	Front panel soft key sets the source active on key press.
T1 (2) Int Pulse	Totalizer intermediate pulse. Active for 1 second when the intermediate count is reached.

Source Name	Description [Comment]
T1 (2) Run State	Totalizer run state 1 = Totalizer running
T1 (2) Wrap Pulse	Totalizer wrap pulse If <i>Wrap Enable</i> is set to <i>On</i> – active for 1 second when the predetermined count is reached. If set to <i>Off</i> – active when the predetermined count has been reached and remains active until the totalizer is reset.

A.2 Analog Sources

Source Name	Description
Anlg IP 1 (2)	Analog input
Constant 1 (8)	Math block constant
Linearizer 1 (2)	Custom linearizer
Math Block 1 (8)	Math block

Appendix B – Configuration Error Codes

Configuration errors are generated when a signal assigned as a source for something has failed. Configuration errors are displayed as numerical codes and a description of each code is shown in the following tables:

Error Code	Error Description
1	Analog Input Value A1 (I/P 1)
2	Analog Input Value A2 (I/P 2)
3	Analog Input Value B1
4	Analog Input Value B2
5	Analog Input Value C1
6	Analog Input Value C2
22	Totalizer Batch total 1
23	Totalizer Secure Total 1
24	Totalizer Batch total 2
25	Totalizer Secure Total 2

Error Code	Error Description
26	Maths Block Value 1
27	Maths Block Value 2
28	Maths Block Value 3
29	Maths Block Value 4
30	Maths Block Value 5
31	Maths Block Value 6
32	Maths Block Value 7
33	Maths Block Value 8
34	Maths Block Constant 1
35	Maths Block Constant 2

Error Code	Error Description
36	Maths Block Constant 3
37	Maths Block Constant 4
38	Maths Block Constant 5
39	Maths Block Constant 6
40	Maths Block Constant 7
41	Maths Block Constant 8
50	PV Maximum Value 1
51	PV Minimum Value 1
52	PV average Value 1
53	Volume Value 1

Error Code	Error Description
54	PV Maximum Value 2
55	PV Minimum Value 2
56	PV average Value 2
57	Volume Value 2
58	Customer Linearizer Value 1
59	Customer Linearizer Value 2
64	Template Block PV Value 1
65	Template Block PV Value 2
70	Analogue Input Fail State A1
71	Analogue Input Fail State A2
72	Analogue Input Fail State B1
73	Analogue Input Fail State B2

Error Code	Error Description
74	Analogue Input Fail State C1
75	Analogue Input Fail State C2
76	Maths Block Fail State 1
77	Maths Block Fail State 2
78	Maths Block Fail State 3
79	Maths Block Fail State 4
80	Maths Block Fail State 5
81	Maths Block Fail State 6
82	Maths Block Fail State 7
83	Maths Block Fail State 8
84	Custom Linearizer Fail State 1
85	Custom Linearizer Fail State 2

Error Code	Error Description
94	Analog Input State A1 (I/P 1)
95	Analog Input State A2 (I/P 2)
110	Digital Input State 1
111	Digital Input State 2
112	Digital Input State 3
113	Digital Input State 4
114	Digital Input State 5
115	Digital Input State 6
123	Totalizer Run State 1
124	Totalizer Wrap Pulse 1
125	Totalizer Intermediate Pulse 1
126	Totalizer Run State 2

ControlMaster CM15

Universal process indicator $1/8$ DIN

Appendix B – Configuration Error Codes

Error Code	Error Description
127	Totalizer Wrap Pulse 2
128	Totalizer Intermediate Pulse 2
131	Logic Equation Result 1
132	Logic Equation Result 2
133	Logic Equation Result 3
134	Logic Equation Result 4
135	Logic Equation Result 5
136	Logic Equation Result 6
137	Logic Equation Result 7
138	Logic Equation Result 8
139	Real Time Alarm State 1
140	Real Time Alarm State 2
141	Alarm State 1

Error Code	Error Description
142	Alarm Ack State 1
143	Alarm State 2
144	Alarm Ack State 2
145	Alarm State 3
146	Alarm Ack State 3
147	Alarm State 4
148	Alarm Ack State 4
149	Alarm State 5
150	Alarm Ack State 5
151	Alarm State 6
152	Alarm Ack State 6
153	Alarm State 7
154	Alarm Ack State 7

Error Code	Error Description
155	Alarm State 8
156	Alarm Ack State 8
167	Analog O/P Loop break A1
168	Analog O/P Loop break B1
177	Delay Timer State 1
178	Delay Timer State 2
189	Toggle Signal
190	Edge Signal

Appendix C – Analog Input (Engineering) Units

Unit	Description
%	%
% sat	% saturation
%dO2	% dissolved oxygen
%HCl	% hydrochloric acid
%N2	% nitrogen
%O2	% oxygen
%OBS	% obscuration
%RH	% relative humidity
A	amps
bar	bar
CUMEC	cubic metre per second
deg C / F	degrees Celsius / Fahrenheit
Feet	imperial feet
ft ³ /d, ft ³ /h, ft ³ /m, ft ³ /s	cubic feet per day, hour, minute, second.
FTU	formazine turbidity units
g/d, g/h, g/l	grams per day, hour, liter

Unit	Description
gal/d (UK)	imperial gallons per day
gal/d (US)	US gallons per day
gal/h (UK) / (US)	imperial / US gallons per hour
gal/m, s (UK) / (US)	imperial / US gallons per minute, second.
Hz	hertz
Inches	imperial inches
Kelvin	degrees Kelvin
kg/d, kg/h, kg/m	kilograms per day, hour, minute.
kg/s	kilograms per second
kHz	kilohertz
l/d, l/h, l/m, l/s	liters per day, hour, minute, second.
lb/d, lb/h, lb/m, lb/s	pounds per day, hour, minute, second.
m WG	meters water gauge
m ³ /d, m ³ /h, m ³ /m, m ³ /s	cubic meters per day, hour, minute, second.
mbar	millibar

ControlMaster CM15

Universal process indicator ¹/₈ DIN

Appendix D – Output Type Assignments

Unit	Description
mg/kg	milligrams per kilogram
Mgal/d (UK)	imperial mega gallons per day
Mgal/d (US)	US mega gallons per day
mho	conductance
MI/d, MI/h	megaliters per day, hour.
ml/h, ml/m	milliliters per hour, minute.
MI/s	megaliters per second
mS/cm, mS/m	milliSiemens per centimeter, meter
mV	millivolts
MV	megavolts
NTU	nephelometric turbidity units
pb	parts per billion
pH	potential Hydrogen

Unit	Description
pm	parts per million
psi	pounds per square inch
S	Siemens
SCFM	standard cubic feet per minute
T/d, T/h, T/m	metric tonnes per day, hour, minute.
T/s	metric tonnes per second
ton/d, ton/h, ton/m, ton/s	imperial tons per day, hour, minute, second.
ug/kg	micrograms per kilogram
uS/cm, uS/m	microSiemens per centimeter / meter
uV	microvolts

Appendix D – Output Type Assignments

Output Type	AO 1	AO 2	DIO 1	DIO 2	RLY1	RLY2	RLY3	RLY4
Analog	OP	PV			ALM 1	ALM 2	ALM 3	ALM 4

...Advanced Level

Refer to Section 7.5, page page 42

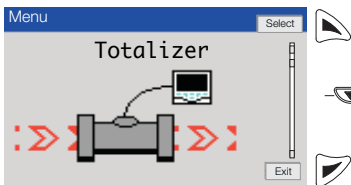

Refer to Section 7.6, page page 49

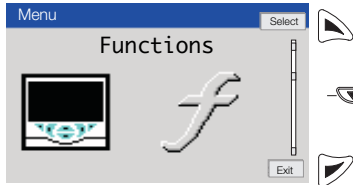

Refer to Section 7.7, page page 59

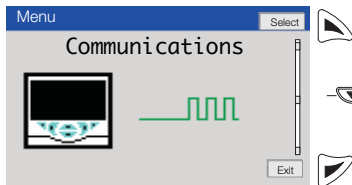

Refer to Section 7.8, page page 59

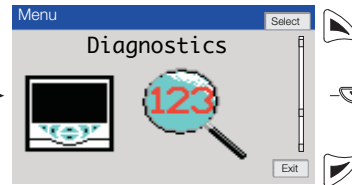

Refer to Section 7.9, page page 63



Totalizer 1 (2)
Mode
Source
Count Direction
Units
Count Rate
Cutoff
Stop Go Source
Total DP's
Preset Count
Predet Count
Intermediate Count
Wrap Enable
Reset Source
Reset Days
Reset Hour

Logic Equations	Linearizer 1 (2)
Equation Number	Source
Operand 1 (8)	Lin 1 (2) Breakpoints
Invert 1 (8)	
Operator 1 (7)	Delay Timer 1 (2)
	Source 1 (2)
Math Blocks	Delay Time
Math Block Number	On Time
Block Type	
Eng. DP's	Real Time Alarms
Eng. Low	Real Time Alarm 1 (2)
Eng. High	
Eng. Units	
Fault Action	
Source 1 (2)	
Source 1 (2) Constant	
Reset Source	
Average Duration	
Operator 1 (3)	
Mux Selector	

Refer to IM/CM/C-EN for
Communication parameter
details.

Diagnostic History
Source Analysis
Analog Source
Digital Source
Invalid Sources

Instrument Type
I/O Build
No. Analog Inputs
No. Analog Outputs
No. Relays
No. Digital I/O
Functionality
Serial No.
Hardware Revision
Software Revision

Customer Support

We provide a comprehensive after sales service via a Worldwide Service Organization. Contact one of the following offices for details on your nearest Service and Repair Centre.

UK

ABB Limited
Tel: +44 (0)1480 475321
Fax: +44 (0)1480 217948

USA

ABB Inc.
Tel: +1 215 674 6000
Fax: +1 215 674 7183

Client Warranty

Prior to installation, the equipment referred to in this manual must be stored in a clean, dry environment, in accordance with the Company's published specification.

Periodic checks must be made on the equipment's condition. In the event of a failure under warranty, the following documentation must be provided as substantiation:

- 1 A listing evidencing process operation and alarm logs at time of failure.
- 2 Copies of all storage, installation, operating and maintenance records relating to the alleged faulty unit.

Contact us

ABB Limited

Process Automation

Howard Road
St. Neots
Cambridgeshire PE19 8EU
UK
Tel: +44 (0)1480 475321
Fax: +44 (0)1480 217948

ABB Inc.

Process Automation

125 E. County Line Road
Warminster
PA 18974
USA
Tel: +1 215 674 6000
Fax: +1 215 674 7183

www.abb.com

Note

We reserve the right to make technical changes or modify the contents of this document without prior notice. With regard to purchase orders, the agreed particulars shall prevail. ABB does not accept any responsibility whatsoever for potential errors or possible lack of information in this document.

We reserve all rights in this document and in the subject matter and illustrations contained therein. Any reproduction, disclosure to third parties or utilization of its contents in whole or in parts – is forbidden without prior written consent of ABB.

Copyright© 2011 ABB
All rights reserved