



ABB MEASUREMENT & ANALYTICS | USER GUIDE – BASIC FUNCTIONALITY | IM/CM/B-EN REV. 5

ControlMaster CM10, CM30 and CM50

Universal process controllers, 1/8, 1/4 and 1/2 DIN

Measurement made easy



For more information

Further publications for the ControlMaster controllers are available for free download from:

www.abb.com/measurement

or by scanning this code:



Search for or click on

Data Sheet

ControlMaster CM10
Universal process controller, 1/8 DIN

[DS/CM10-EN](#)

Data Sheet

ControlMaster CM30
Universal process controller, 1/4 DIN

[DS/CM30-EN](#)

Data Sheet

ControlMaster CM50
Universal process controller, 1/2 DIN

[DS/CM50-EN](#)

Communications Supplement

ControlMaster CM10, CM15, CM30, CM50, CMF160 and CMF310
Universal process controllers and indicator, 1/8, 1/4, 1/2 DIN and fieldmount

[IM/CM/C-EN](#)

Basic Level

Refer to Section 6, page 28

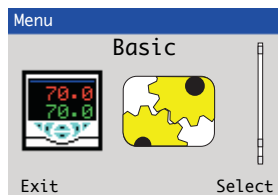

Loop 1 Setpoints
Local Setpoint 1 (4)
RSP Ratio
RSP Bias
Ramp Mode
Ramp Rate
Loop 1 Control
On/Off Hysteresis
Mode
Autotune
PID
Loop 1 Time Prop
Cycle Time 1
Cycle Time 2
Alarm 1 (8)
Trip

*Advanced Level ...

Refer to Section 7.1, page 35

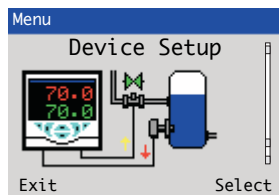

Initial Setup
App. Template
Loop 1 Output Type
Loop 1 Split O/P
Instrument Tag
Mains Freq.
Config Action
Reset to Defaults
Security Setup
Basic Password
Advanced Password
Reset Passwords

Refer to Section 7.2, page 38

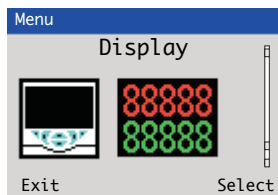

Language
Operator Templates
Page 1 (4) Template
Operator Functions
Autoscroll
Soft Key Function
Auto Manual Enable
Local Remote Enable
Alarm Ack. Enable
SP Adjust Enable
Settings
Brightness
Contrast**

Refer to Section 7.3, page 41

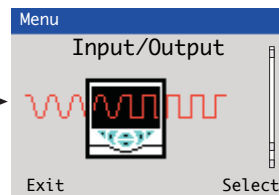

Analog Inputs
Anlg Input 1 (4)
Analog Outputs
Analog Output 1 (2)
Digital I/O
Digital IO 1 (6)
Relays
Relay 1 (4)

Refer to Section 7.4, page 49

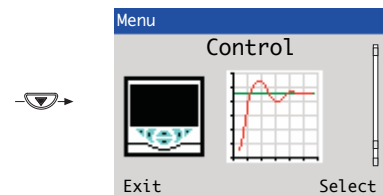

Loop 1 Setpoints
Low Limit
High Limit
No. of Local SP's
Local Setpoint 1
Track Mode
RSP Ratio
RSP Bias
RSP Fault Action
Default Setpoint
Ramp Mode
Ramp Rate
Select Sources
Loop 1 Control
Control Type
Control Action
On/Off Hysteresis
Autotune
PID
Loop 1 Output
Limits
Failure Actions
A/M Select Sources
Slew Rate
Loop 1 Split O/P
Min Input 1
Min OP 1
Max Input 1
Max OP 1
Min Input 2
Min OP 2
Max Input 2
Max OP 2
Loop 1 Time Prop
Cycle Time 1
Cycle Time 2

See Back Cover

*When in Advanced Level (configuration) mode, press and hold the  key to return to the standard Operator page – see Fig. 3.1, page 6

**Enabled for CM30 and CM50 only

Contents

1 Safety	3	4 Installation	9
1.1 Electrical Safety	3	4.1 Siting and Environmental Requirements	9
1.2 Symbols	3	4.2 Dimensions	10
1.3 Health & Safety	4	4.3 Mounting	12
2 Introduction	5	4.4 Jumper Links for Relay Outputs	13
2.1 EC Directive 89/336/EEC	5	4.4.1 Removing the Controller from its Case	13
2.2 End of Life Disposal	5	4.4.2 Resetting Jumper Links	14
3 Displays, Overview	6	4.5 Electrical Connections	15
3.1 CM10 Operator Page, Icons & Keys	6	4.5.1 ControlMaster CM10 Electrical Connections	16
3.2 CM30 and CM50 Operator Page, Icons & Keys	7	4.5.2 ControlMaster CM30 Electrical Connections	17
		4.5.3 ControlMaster CM50 Electrical Connections	18
		4.5.4 Analog Inputs	19
		4.5.5 Frequency / Pulse Input	21
		4.5.6 Digital Input / Output	21

5 Operator Level Menus	23	9 PC Configuration	72
5.1 Diagnostic Status Bar	25	10 Specification	73
5.2 Diagnostic View	26	Notes	81
5.3 Security Options	26	Appendix A – Digital and Analog Sources	82
5.4 Access Level	27	A.1 Digital Sources	82
6 Basic Level	28	A.2 Analog Sources	82
7 Advanced Level	35	Appendix B – Configuration Error Codes	83
7.1 Device Setup	35	Appendix C – Analog Input (Engineering) Units	86
7.2 Display	38	Appendix D – Output Type Assignments	88
7.3 Input/Output	41		
7.4 Control	49		
7.5 Process Alarm	61		
7.6 Communication	63		
7.7 Diagnostics	64		
7.7.1 Diagnostic Messages	66		
7.8 Device Info	70		
8 Templates and Functionality	71		
8.1 Single Loop / Single Loop with Remote Setpoint	71		

1 Safety

Information in this manual is intended only to assist our customers in the efficient operation of our equipment. Use of this manual for any other purpose is specifically prohibited and its contents are not to be reproduced in full or part without prior approval of the Technical Publications Department.









1.1 Electrical Safety

This equipment complies with the requirements of CEI/IEC 61010-1:2001-2 'Safety Requirements for Electrical Equipment for Measurement, Control and Laboratory Use' and complies with US NEC 500, NIST and OSHA.

If the equipment is used in a manner NOT specified by the Company, the protection provided by the equipment may be impaired.

1.2 Symbols

One or more of the following symbols may appear on the equipment labelling:

	Warning – Refer to the manual for instructions
	Caution – Risk of electric shock
	Functional earth (ground) terminal
	Protective earth (ground) terminal
	Direct current supply only
	Alternating current supply only
	Both direct and alternating current supply
	The equipment is protected through double insulation

1.3 Health & Safety

Health and Safety

To ensure that our products are safe and without risk to health, the following points must be noted:

- The relevant sections of these instructions must be read carefully before proceeding.
- Warning labels on containers and packages must be observed.
- Installation, operation, maintenance and servicing must be carried out only by suitably trained personnel and in accordance with the information given.
- Normal safety precautions must be taken to avoid the possibility of an accident occurring when operating in conditions of high pressure and / or temperature.

Safety advice concerning the use of the equipment described in this manual or any relevant hazard data sheets (where applicable) may be obtained from the Company, together with servicing and spares information.

2 Introduction

This manual provides details for the ControlMaster CM10 (1/8 DIN), CM30 (1/4 DIN) and CM50 (1/2 DIN) controllers with Basic functionality.

Note.

- Read all relevant sections of this guide before configuring the system or modifying system parameters.
- Install and use associated equipment in accordance with the relevant national and local standards.
- System configuration must be carried out only by users or personnel with approved access rights (user privileges).

2.1 EC Directive 89/336/EEC

In order to meet the requirements of the EC Directive 89/336/EEC for EMC regulations, this product must be used in an industrial environment.

2.2 End of Life Disposal

Controllers with Basic functionality do not contain any substance that causes undue harm to the environment and must be disposed of in accordance with the Directive on Waste Electrical and Electronic Equipment (WEEE). They must not be disposed of in Municipal Waste Collection.

3 Displays, Overview

3.1 CM10 Operator Page, Icons & Keys

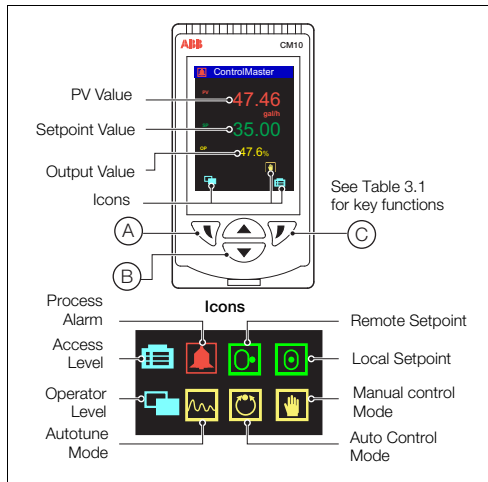

Fig. 3.1 ControlMaster CM10 Display and Icons

(A)	Navigation (left) / <i>Operator Level</i> access key – see page 23.
(B)	Up / Down keys – highlight menu items and increase / decrease displayed values.
(C)	Navigation key (right) / programmable <i>Soft Key</i> – see page 39.

Table 3.1 CM10 Front Panel Key Functions

Note. When a *Soft Key* option is assigned to key (C), the *Advanced Level* (see page 35) must be accessed using the *Operator Level* access key (A).

3.2 CM30 and CM50 Operator Page, Icons & Keys

The ControlMaster CM30 and CM50 displays and icons are shown in Fig. 3.2.

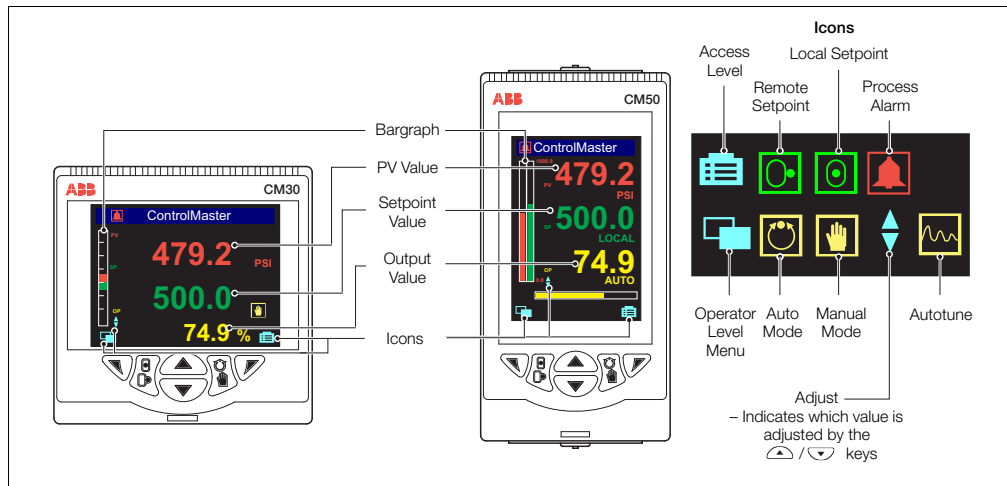

Fig. 3.2 ControlMaster CM30 and CM50 Displays and Icons

The ControlMaster CM30 and CM50 front panel keys are shown in Fig. 3.3.

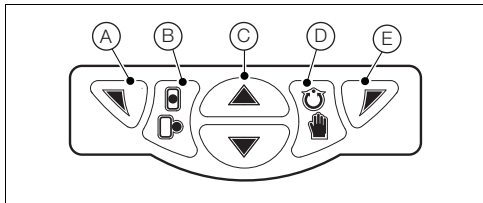

Fig. 3.3 ControlMaster CM30 and CM50 Front Panel Keys

(A)	Navigation (left) / <i>Operator Level</i> access key – see page 23.
(B)	Local / Remote setpoint mode selection key.
(C)	Up / Down keys – navigate up / down menus and increase / decrease displayed values.
(D)	Auto / Manual control mode selection key.
(E)	Navigation key (right) / programmable <i>Soft Key</i> – see page 39.

Table 3.2 CM30 / CM50 Front Panel Key Functions

Note. When a *Soft Key* option is assigned to key (E), the *Advanced Level* (see page 35) must be accessed using the *Operator Level* access key (A).

4 Installation

4.1 Siting and Environmental Requirements

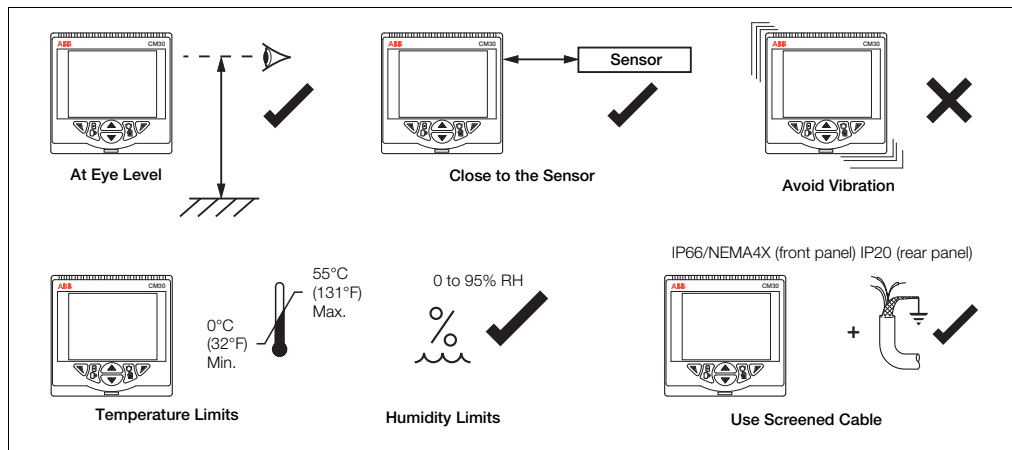

Fig. 4.1 Siting and Environmental Requirements

4.2 Dimensions

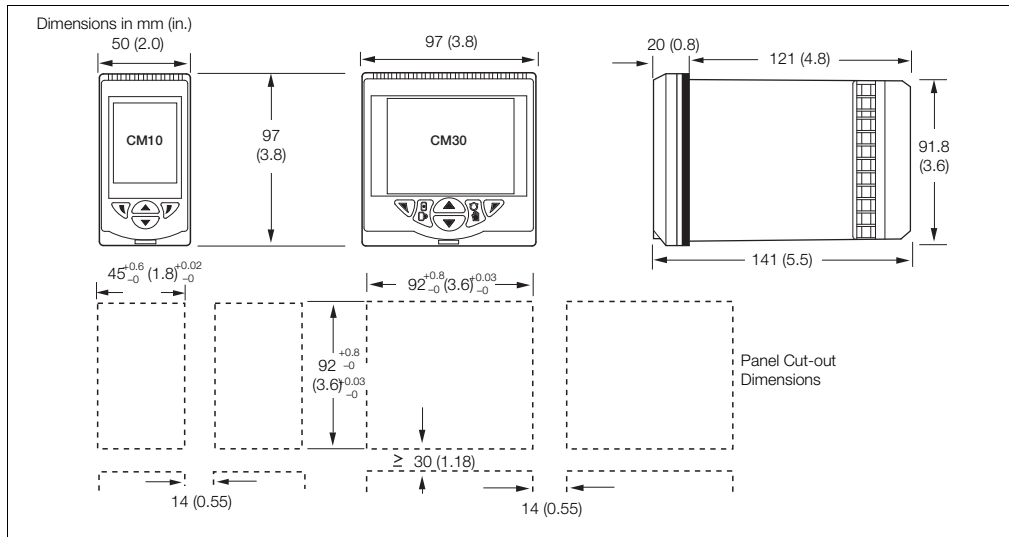

Fig. 4.2 ControlMaster CM10 and CM30 Dimensions

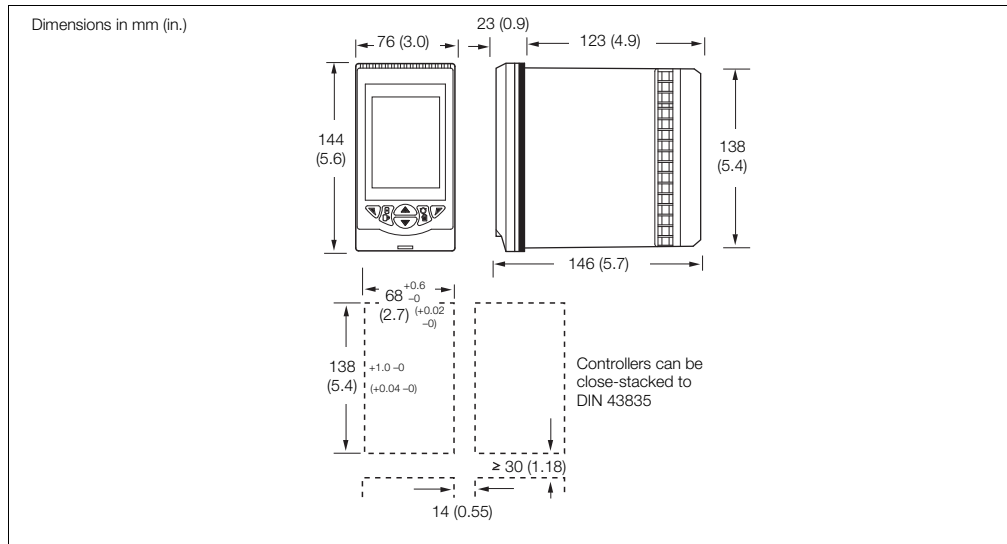

Fig. 4.3 ControlMaster CM50 Dimensions

4.3 Mounting

ControlMaster is designed for panel mounting. For NEMA4X protection, a panel thickness of 2.5 mm (0.1 in.) is required.

To panel-mount the controller:

1. Cut a hole of the correct size for the controller in the panel – see section 4.2, page 10 for dimensions.
2. Insert the controller into the panel cut-out.

Referring to Fig. 4.4:

3. Position the upper panel clamp (A) at the top front of the case against the panel.
4. Locate the panel clamp anchor (B) in slot (C).
5. Tighten the panel clamp anchor screw (D) until panel clamp (A) is secured against the panel.

Caution. Do not overtighten the screw.

6. Repeat steps 3 to 5 to fit the lower panel clamp (E) and panel clamp anchor (F).

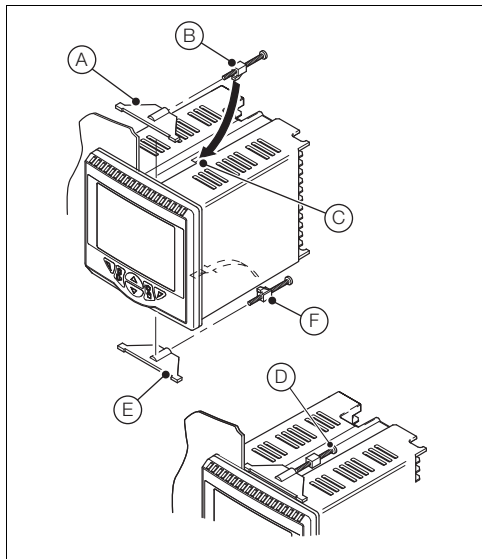

Fig. 4.4 Mounting Details

4.4 Jumper Links for Relay Outputs

The factory-set default for relay action is N/O.

4.4.1 Removing the Controller from its Case

The ControlMaster inner assembly must be removed from its case to access the relay contact jumper links.

Referring to Fig. 4.5:

1. Insert the bezel release tool (A) (supplied) into the front panel slot (B) below the function keys.
2. Press the bezel release tool (A) fully in and then down (C) until the shoulder on the tool engages with the notch behind the controller front plate.
3. Pull the bezel release tool (A) to withdraw the inner assembly from the case (D).

Note. If the bezel release tool is mislaid, 2 small flat-headed screwdrivers (4 mm [0.15 in.]) can be used as alternative tools, one inserted into the front panel slot and the second for leverage in the notch on the underside of the controller front plate. The notch is the only area that can be used as a leverage point – do not attempt to lever the front panel from any other area.

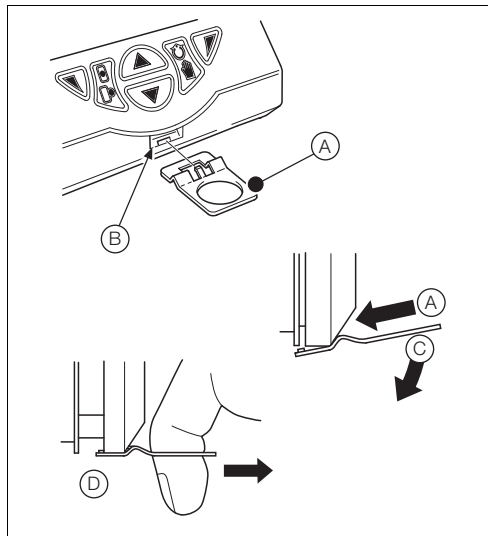

Fig. 4.5 Removing the Controller from its Case

4.4.2 Resetting Jumper Links

Note. The factory-set default for all jumper links is N/O.

1. The links associated with the relay outputs are shown in Fig. 4.6.
2. If necessary, move the link to select the relay action required (N/O or N/C).

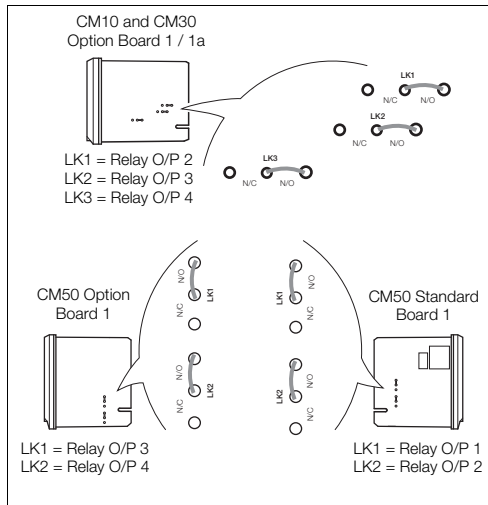

Fig. 4.6 Jumper Links for Relay Outputs

4.5 Electrical Connections

Warning.

- The instrument is not fitted with a switch therefore a disconnecting device such as a switch or circuit breaker conforming to local safety standards must be fitted to the final installation.
- It must be mounted in close proximity to the instrument within easy reach of the operator and must be marked clearly as the disconnection device for the instrument.
- Remove all power from supply, relay and any powered control circuits and high common mode voltages before accessing or making any connections.
- Use cable appropriate for the load currents. The terminals accept cables from 18 to 14 AWG (0.8 to 2.5mm²).
- Always route signal leads and power cables separately, preferably in earthed (grounded) metal conduit.
- It is strongly recommended that screened cable is used for signal inputs and relay connections.
- The instrument conforms to Mains Power Input Overvoltage Category 2, Pollution Degree 2 (EN601010-1). (This equipment is protected through double insulation – Class II.)
- Analog / digital inputs and outputs, transmitter power supply and DC power supply are SELV (Safety Extra Low Voltage) circuits.
- All connections to secondary circuits must have basic insulation.
- After installation, there must be no access to live parts, e.g. terminals.
- Terminals for external circuits are for use only with equipment with no accessible live parts.
- If the instrument is used in a manner not specified by the Company, the protection provided by the equipment may be impaired.
- All equipment connected to the instrument's terminals must comply with local safety standards (IEC 60950, EN601010-1).

Note. Terminal screws must be tightened to a torque of 0.1 Nm (0.9 lbf/in.).

4.5.1 ControlMaster CM10 Electrical Connections

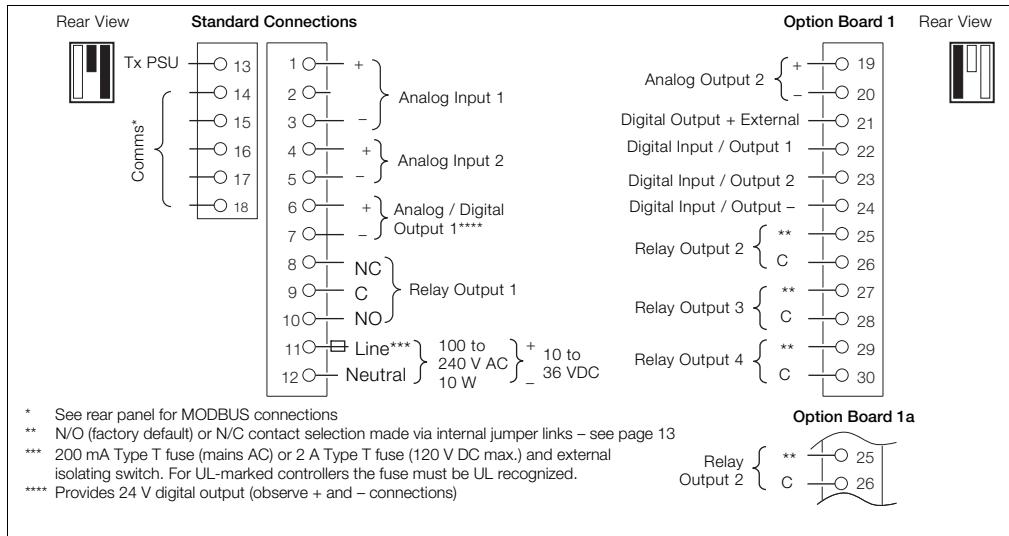

Fig. 4.7 ControlMaster CM10 Electrical Connections

4.5.2 ControlMaster CM30 Electrical Connections

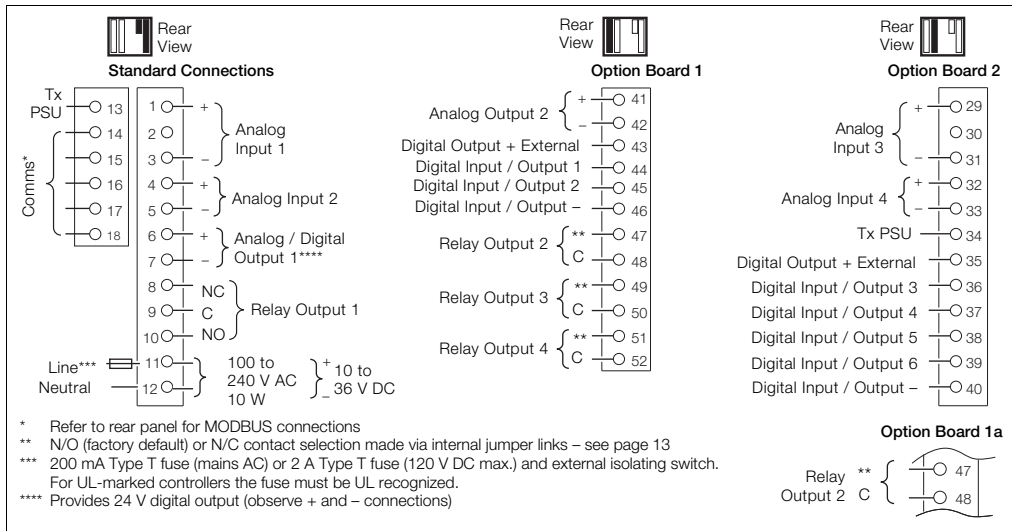

Fig. 4.8 ControlMaster CM30 Electrical Connections

4.5.3 ControlMaster CM50 Electrical Connections

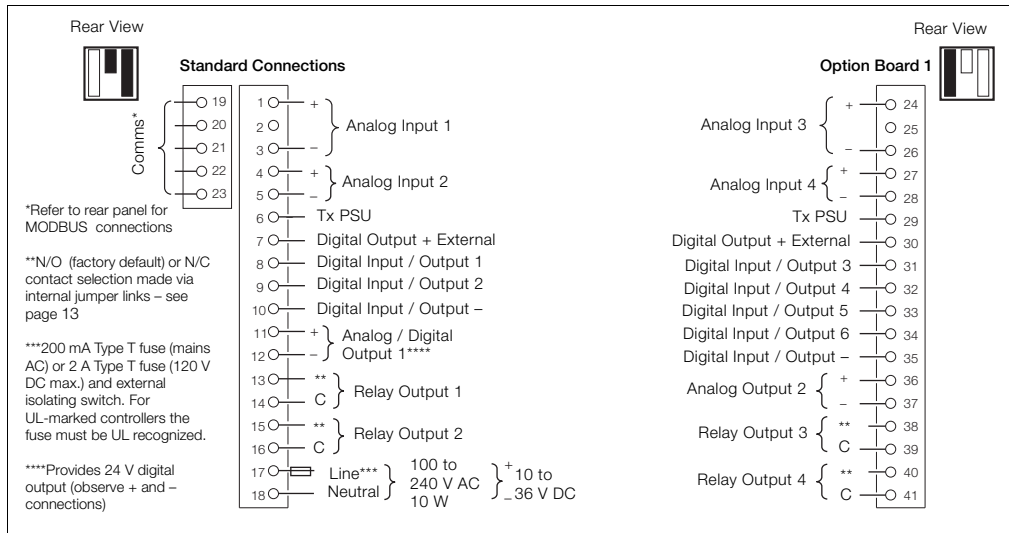

Fig. 4.9 ControlMaster CM50 Electrical Connections

4.5.4 Analog Inputs

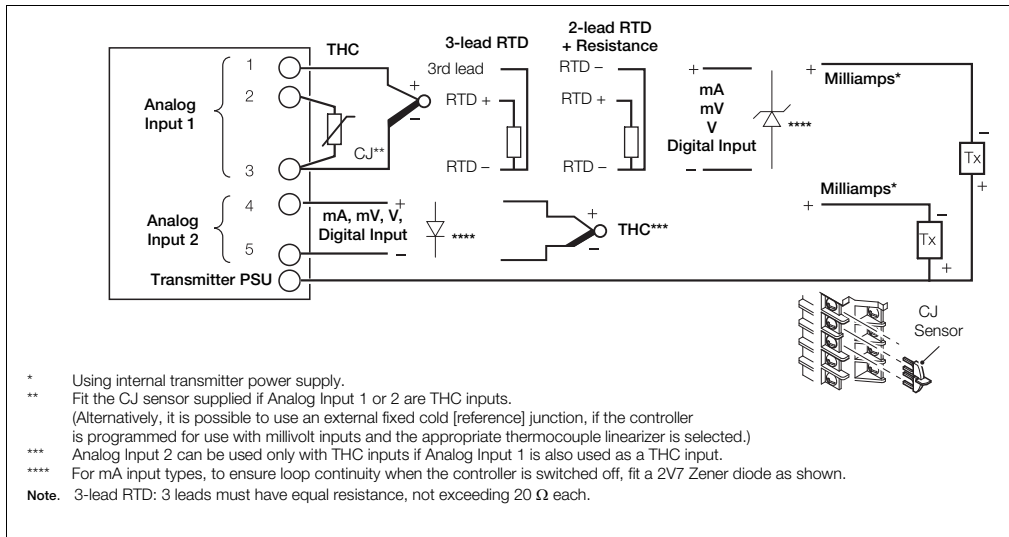

Fig. 4.10 Standard Analog Inputs (1 and 2)

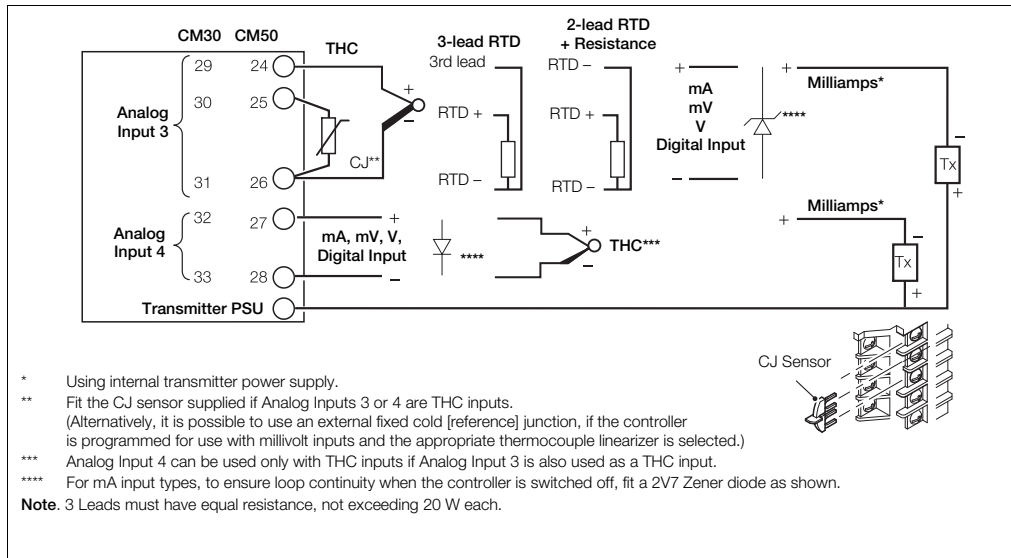

Fig. 4.11 ControlMaster CM30 and CM50 Optional Analog Inputs (3 and 4)

4.5.5 Frequency / Pulse Input

Note. This input is designed primarily for use with flowmeters.

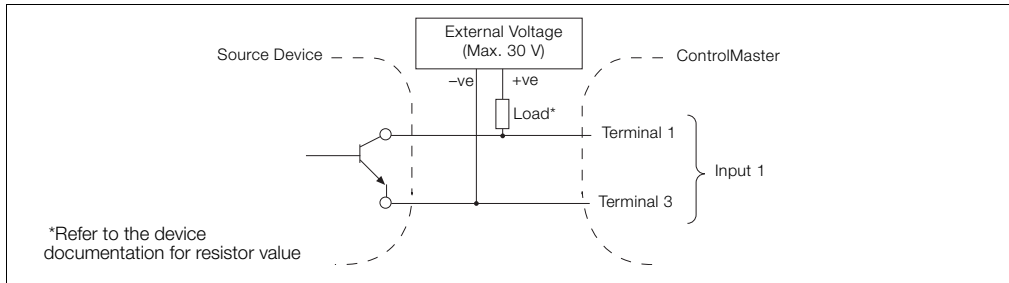

Fig. 4.12 Frequency / Pulse Input

4.5.6 Digital Input / Output

Note. Digital input and open collector digital output connections are shown in Fig. 4.13 – see page 82 for Digital Input / Output type options.

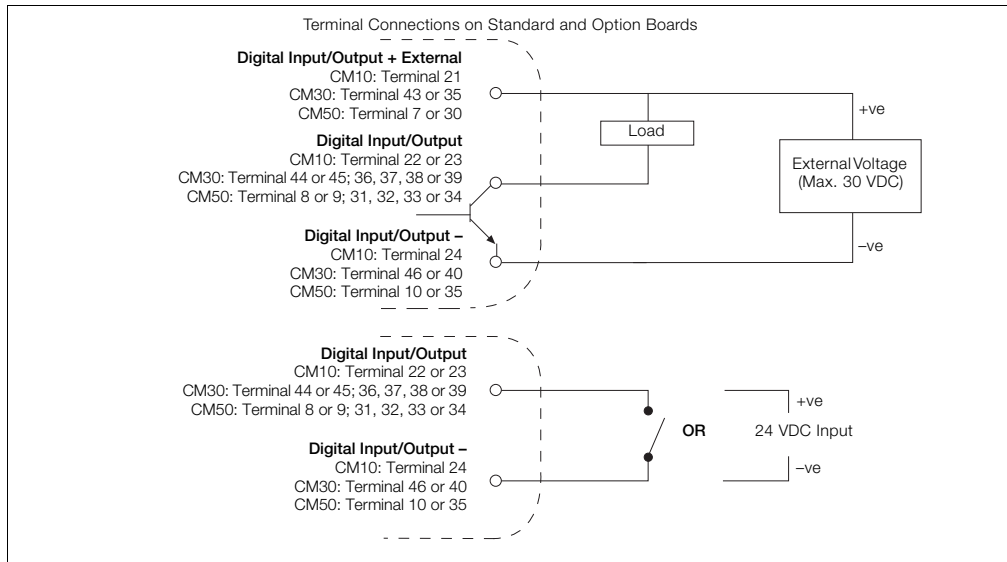
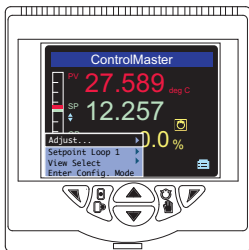







Fig. 4.13 Digital Input and Open Collector Digital Output Connections

5 Operator Level Menus



Operator level menus are used to adjust setpoint(s) and output(s), select setpoints, select the view and to enter *Basic* and *Advanced* modes (via the *Access* level) – see page 27.

To access Operator Level menus:

1. From the *Operator Page*, press  to view the available menus.
2. Use the  /  keys to scroll through the menus and menu options.
3. Press  to expand menu levels and to select menu options or press  to return to the previous menu.

Menu functions are described in Table 5.1 page 24.



Autotune	Used to start or stop an <i>Autotune</i> routine. This menu is enabled only if <i>Autotune</i> mode is <i>On</i> – see page 30.
Adjust	Enables a value to be adjusted using the  /  keys. The  icon next to a value indicates the current adjustable selection.
Setpoint Select	Selects the local setpoint to be used (displayed only if more than 1 local setpoint is configured).
Alarm Acknowledge	Acknowledges any active but unacknowledged alarms.
View Select	Selects the <i>Operator</i> view to be displayed.
Enter Advanced Level	Displays the <i>Access Level</i> selection views – see section 5.4, page 27 for security options.

Table 5.1 Operator Level Menu Functions

5.1 Diagnostic Status Bar

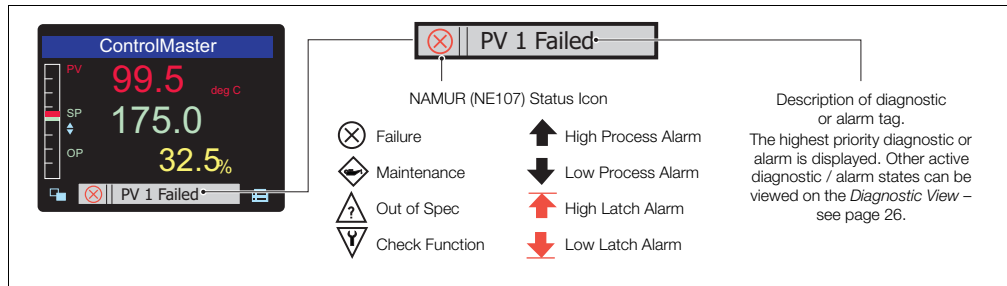

Fig. 5.1 ControlMaster Diagnostic Status Bar (ControlMaster CM30 Shown)

5.2 Diagnostic View

The *Diagnostic View* can be selected from the *Operator / View Select* menu. All currently active diagnostic alarm states are displayed in the *Diagnostic View*.

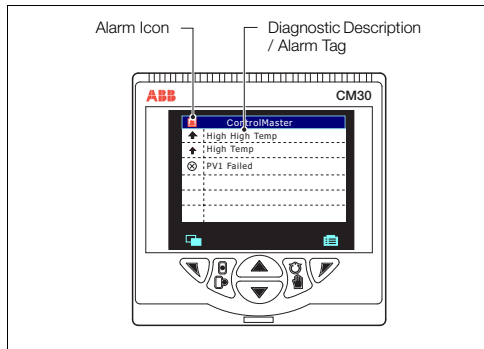

Fig. 5.2 ControlMaster Diagnostic View
(ControlMaster CM30 Shown)

5.3 Security Options

Passwords can be set to enable secure end-user access at 2 levels: *Basic* and *Advanced*. A *Service* level is also listed, this is password-protected at the factory and reserved for factory use only.

Passwords are set, changed or restored to their default settings at the *Device Setup / Security Setup* parameter – see page 37.

Note. When the controller is powered-up for the first time the *Basic* and *Advanced* level levels can be accessed without password protection. Protected access to these levels must be allocated on-site as required.

5.4 Access Level

Level	Access
Logout	Displayed after <i>Basic</i> or <i>Advanced</i> level are accessed. Logs the user out of <i>Basic</i> or <i>Advanced</i> level. If passwords are set, a password must be entered to access these levels again after selecting <i>Logout</i> .
Read Only	Enables all parameter settings to be viewed as read-only parameters.
Basic	Enables access to the <i>Basic</i> level and adjustment of <i>PID</i> parameters, autotuning configuration and adjustment of alarm trip points.
Advanced	Enables configuration access to all parameters.
Service	Reserved for use by authorized service personnel.

Table 5.2 Access Levels

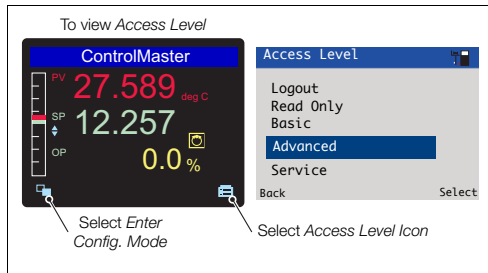
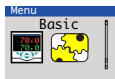

Fig. 5.3 Access Level

Note. A 5-minute time-out period enables a user to return to the *Operator* page and re-access the previous menu (displayed at exit) without re-entering the password. For periods over 5-minutes (or if *Logout* is selected), a password must be re-entered to access protected levels.

6 Basic Level



The *Basic* menu provides access to the tunable control settings and setpoint values.

Loop 1 Setpoints

Local Setpoint 1(4)	The local setpoint value required. If this value is adjusted in the <i>Operator Level</i> (see page 23) its value here is also updated.
RSP Ratio	If the remote (external) setpoint is selected, the control setpoint value is (ratio x remote setpoint input) + bias.
RSP Bias	Sets the remote setpoint bias in engineering units. Note. This parameter is available only if template selected has remote setpoint or ratio functionality – see Section 8, page 71.

...Basic / ...Loop 1 Setpoints

Ramp Mode

The ramping setpoint facility can be used to prevent a large disturbance to the control output when the setpoint value is changed. The rate set applies to both the local and the remote setpoints.

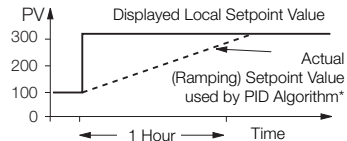

*Example: Ramp Rate = 200 Increments / hr

Ramp Rate

Sets the ramp rate required in engineering units / hour.

Note. Applicable only if Ramp Mode is On.

Loop 1 Control

On / Off Hysteresis

Sets the hysteresis value in engineering units.

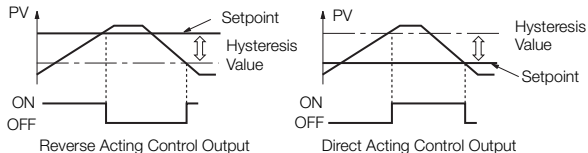

Note. Applicable only if Control Type is On / Off – see page 53.

...Basic / ...Loop 1 Control

Mode	Turns the <i>Autotune</i> functionality on or off. When set to <i>On</i> , an <i>Autotune</i> can be started from the Operator level menus – see page 23.
------	---

Autotune	Note. Autotune is enabled only if the control type is PID – see page 32.
-----------------	---

Autotune is a user-activated feature that enables automatic setting of the controller *PID* parameters using an 'at setpoint' type algorithm. *Autotune* changes the controller output and then monitors the process response to calculate the optimum *PID* settings. *Autotune* uses a relay type function with hysteresis that initiates a controlled oscillation in the process. New *PID* parameters are calculated and stored in the controller automatically.

Note. To achieve the best results from Autotune, switch the controller to Manual control mode (see page 6) and adjust the output until the PV is stable (close to the normal setpoint) before initiating Autotune.

...Basic / ...Loop 1 Control / ...Autotune

Autotune Operation

The *Autotune* sequence is shown in the following figure:

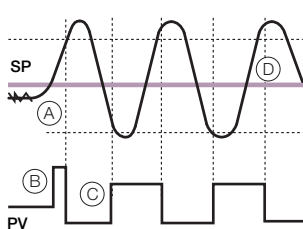

- ① Set the first step value and dynamics required. For best results, select the largest initial output step size that can be tolerated by the process.
- ② *Autotune* is enabled only if the control type is *PID*.
- ③ Start *Autotune* from the *Operator* menu.
- ④ Monitors a noise (A) and calculates a hysteresis value.
- ⑤ User-defined initial step in the output (B). When the process exceeds the hysteresis value the output is stepped down.
- ⑥ Adjusts output amplitude automatically (C) so PV disturbance is kept to minimum required.
- ⑦ When consistent oscillation is established (D), the *Autotune* process stops. Optimum settings are calculated from the process dynamics monitored.

...Basic / ...Loop 1 Control / ...Autotune

First Step	Defines the maximum size of the first output step in the autotuning process. <i>Autotune</i> adjusts the output step magnitude according to the process noise and response to provide a reliable measurement of the process characteristics with the minimum disturbance of the process. The maximum setting provides the largest output step possible from the current output value.
Dynamics	Used to configure <i>Autotune</i> to give optimum results according to the type of process being controlled.
<i>Normal</i>	Determines if derivative control is required automatically and calculates the control settings accordingly.
<i>Deadtime</i>	Sets the proportional and integral terms to give optimum control for the deadtime process (higher proportional band [lower gain] and shorter integration time).
<i>PI</i>	Used for processes where it is known that derivative control is not required.
Reset	If the controller is transferred to another process or duty, <i>Autotune</i> must be reset. The current <i>PID</i> (see page 32) settings are retained but the internal process data is cleared ready for a completely new process with different characteristics.
PID	The controller's <i>PID</i> (proportional, integral and derivative control) settings can be commissioned using the <i>Autotune</i> (see page 30) function and / or they can be adjusted manually.
Proportional Band 1	Set as % of engineering range.
Integral Time 1	Set in seconds per repeat. To turn integral action off, set to 0 or 10000 s.
Derivative Time 1	Set in seconds.

...Basic / ...Loop 1 Control / ...PID

Manual Reset	When the <i>Integral Time</i> is <i>Off</i> , the manual reset parameter is activated. When the process variable is equal to the control setpoint, the output value is equal to the manual reset value.
--------------	---

Note: The controller is shipped with null PID values ($P = 100$, $I = \text{off}$ & $D = 0$). To enable the controller to control the process it is connected to, these values must be tuned accordingly. This can be achieved via the AutoTune function or manual adjustment. If the controller is tuned manually the table below provides details of some suggested values to start from. These values are only suggested starting values and should not be used as an alternative to proper tuning of the Controller.

Process Type	P	I
Temperature (fast)*	10	30
Temperature (slow)*	10	300
Pressure (fast)	100	1
Pressure (slow)	10	30
Level (fast)	100	1
Level (slow)	10	30
Flow	100	1

*For temperature loops, control performance can be improved via the use of Derivative. A suggested starting value is $1/6^{\text{th}}$ of the Integral value.

...Basic

Loop 1 Time Prop

The active time of the output pulse is proportional to the value of the control output. With 100% output the pulse is active for the complete cycle time, for example:

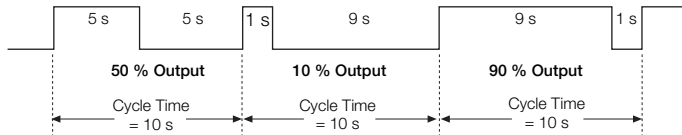

Note. Applicable only if Output Type is Time Prop or Split Output (and one output is a relay or a digital output) – see page 35.

Cycle Time 1(2)

The cycle time to be used with time proportioning outputs. For split outputs, the *Cycle Time 1* setting applies to *Output 1* and *Cycle Time 2* setting applies to *Output 2* – see page 35.

Alarm 1 (8)**Trip**

The alarm trip level in engineering units – see *Process Alarm* (page 62) for parameter details.

7 Advanced Level

7.1 Device Setup

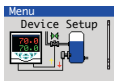

Provides access to standard setup parameters to determine the type of control / indication required. Also provides the ability to create non-standard configurations for special application requirements.

Initial Setup

App Template

Application templates enable configurations for particular applications to be created as simply as possible. Select the appropriate template before configuring any other parameters. When a template is selected, the Controller assumes the preset form for that template. The inputs and function blocks are soft-wired automatically to perform the selected function.

Note. See Section 8, page 71 for templates available to ControlMasters with Basic functionality.

Loop 1 Output Type

The appropriate output function block, relay, digital and analog outputs are configured and soft wired – see Appendix D, page 88 for output assignments.

...Device Setup / ...Basic Setup

Loop 1 Split O/P	These types of outputs split the <i>Control (PID)</i> output signal (see page 32) into 2 signals. The linear relationship between the PID output and the 2 outputs can be configured in the control configuration.
Instrument Tag	A 16-character alphanumeric tag, displayed on <i>Operator</i> pages.
Mains Freq	Used to set the internal filters to reduce mains power frequency interference.
Config Action	The <i>Config Action</i> parameter is used to determine how the controller and controller outputs behave when the <i>Advanced</i> level is entered – see page 35.
<i>Continue</i>	The controller continues to operate as in <i>Operator</i> level. Outputs continue to operate as normal.
<i>Hold</i>	Puts the controller into <i>Manual</i> control mode. When the <i>Configuration</i> level is exited, the controller returns to the <i>pre-Configuration</i> mode of operation. Digital, relay and analog outputs are held at their value / state when <i>Configuration</i> mode is entered.
<i>Inactive</i>	Puts the controller into <i>Manual</i> control mode. When the <i>Advanced</i> level is exited, the controller returns to the <i>pre-configuration</i> mode of operation. Digital and relay outputs are turned off. Analog outputs are set to 0 mA.
Reset to Defaults	Resets all configuration parameters to their default values.

...Device Setup

Security Setup

2 Security access levels are provided, each protected by a password of up to 6 alphanumeric characters.

Note. Passwords are not set at the factory and must be entered by the end user(s).

Basic Password

Basic level provides access to the *Basic* level – see section 6, page 28.

Advanced Password

Provides access to all configuration parameters – see section 5.4, page 27.

Reset Passwords

Resets all passwords to factory values.

7.2 Display

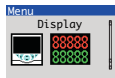

Used to setup the operator page, displayed language and display hardware settings.

Language	Selects the language on the controller's local display.
Operator Templates	Enables up to 4 operator pages to be configured to suit the application requirements.
Page 1 (to 4) Template	The operator template type. The functions available in each template type are displayed as abbreviations, for example: <i>Single PV, SP & OP</i> Key to abbreviations: <ul style="list-style-type: none">■ PV = process variable■ SP = setpoint■ OP = control output

...Display

Operator Functions

Autoscroll	When enabled (<i>On</i>), operator pages are scrolled continuously at intervals of 10 seconds per page.
Soft Key Function	Assigns a dedicated function to the Navigation key (right) – see page 6.
<i>Configuration</i>	Displays the <i>Access Level</i> enabling selection of configuration levels.
<i>Auto / Manual</i>	Toggles between <i>Auto</i> and <i>Manual</i> control modes.
<i>Local / Remote</i>	Toggles between <i>Local</i> and <i>Remote</i> setpoint modes.
<i>Scroll View</i>	Scrolls through each available <i>Operator view</i> .
<i>Alarm Ack</i>	Acknowledges all active unacknowledged alarms.
<i>Toggle Signal</i>	Provides source that toggles between 2 states – can be assigned to outputs or used to select sources.
<i>Edge Signal</i>	Provides an edge-triggered source that is active on key press. Can be assigned to outputs or used to select sources

...Display /...Operator Enable Functions

Auto Manual Enable	Turns on / off the ability for <i>Auto / Manual</i> control mode to be changed in <i>Operator Level</i> .
Local Remote Enable	Turns on / off the ability for local / remote setpoint mode to be changed in <i>Operator Level</i> .
Alarm Ack. Enable	Turns on / off the ability to acknowledge alarms from the front panel.
SP Adjust Enable	Turns on / off setpoint adjustment in the <i>Operator Level</i> .
Settings	Adjusts display settings to suit ambient conditions.
Brightness	Increases / Decreases the display brightness to suit local environmental conditions.
Contrast	Increases / Decreases the display contrast to suit local environmental conditions (enabled for CM30 and CM50 only).

7.3 Input/Output

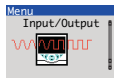

Allows analog and digital inputs / outputs and relays to be configured.

Analog Inputs

Analog Input 1(4)*

Input Type

Input types comprise: *Millivolts, Milliamps, Volts, Resistance (Ohms), RTD, Thermocouple, Digital volt-free, 24V Digital, Freq. Input, Pulse Input.*

Additional *Input Type* comments:

Digital Volt Free

Acts as a digital input.

Freq. Input

Sets the maximum frequency and equivalent flow rate in the engineering range 0 to 6 KHz. (A frequency up to 6 KHz can be used to create an analog value.)

Pulse Input

This parameter counts pulses and is recommended only for use with electromagnetic flowmeters.

*Analog Inputs 2 to 4: *Freq Input, Pulse Input* and *Resistance* not available.

A *Thermocouple* input type can be set only if the first input is set to *Thermocouple*.

... Input/Output / ...Analog Input 1(4)

Elect. Low

Sets the required electrical range.

Note. Applicable only to Millivolts, Milliamps, Volts and Ohms.

Linear Inputs	Standard Analog Input	Accuracy (% of Reading)
Millivolts	0 to 150 mV	0.1 % or $\pm 20 \mu\text{V}$
Milliamps	0 to 45 mA (CM10 & CM30) 0 to 50 mA (CM50)	0.2 % or $\pm 4 \mu\text{V}$
Volts	0 to 25 V	0.2 % or $\pm 1 \text{ mV}$
Resistance Ω (low)	0 to 550 Ω	0.2 % or $\pm 0.1 \Omega$
Resistance Ω (high)	0 to 10 k Ω	0.1 % or $\pm 0.5 \Omega$

Elect. High

Sets the required electrical range.

Note. Applicable only to Millivolts, Milliamps, Volts and Freq. Input.

Linearizer

Selects the linearizer type required to condition the input signal.

Notes. For thermocouple applications using an external fixed cold junction, set Input Type to Millivolts (see page 41) and select the appropriate linearizer type.

Not applicable for *Pulse Input*, *Digital Volt Free*, *24Volt Digital* parameters – see page 41.

... Input/Output / ...Analog Input 1(4)

Eng Units	<p>The selected units are used by the linearizer and displayed in the <i>Operator</i> pages – see page 23.</p> <p>Not applicable for <i>Pulse Input</i>, <i>Digital volt-free</i> or <i>24V Digital</i> parameters – see page 41.</p> <p><i>Thermocouple</i> and <i>RTD</i> inputs (see page 41) are restricted to <i>deg C</i>, <i>deg F</i>, <i>Kelvin</i> – see Appendix 86, page 86 for analog input units.</p>
Eng. Dps	<p>Engineering decimal places – selects the resolution (decimal places) displayed for the input value.</p>
Eng. Low	<p>Specifies the engineering low (minimum) / high (maximum) value.</p>
Eng. High	<p>For example, for an electrical input range of 4.0 to 20.0 mA, representing a pressure range of 50 to 250 bar (725 to 2630 psi), set the <i>Eng Low</i> value to 50.0 and the <i>Eng High</i> value to 250.0.</p> <p>Not applicable for <i>Pulse Input</i>, <i>Digital volt-free</i> or <i>24V Digital</i> parameters – see page 41.</p>
Pulse Units	<p>Selects the unit of measure for the pulse input type.</p>
Pulse / Unit	<p>Sets the number of pulses required to represent 1 pulse unit (as set above). For example, if <i>Pulse Units</i> = KI and <i>Pulse / Unit</i> = 10.00000000, each pulse represents 0.1 KI, 10 pulses = 1 KI.</p>

... Input/Output / ...Analog Input 1(4)

Broken Sensor	If an input failure occurs, the input value can be configured to drive in a set direction.
<i>None</i>	No action taken.
<i>Automatic</i>	If the value of failed input is below <i>Eng Low</i> (see page 43), the input value is driven to minimum downscale value; otherwise it is driven to the maximum upscale value.
<i>Upscale</i>	The input is driven to the maximum upscale value.
<i>Downscale</i>	The input is driven to the minimum downscale value.
Filter Time	The input is averaged over the time set.
Fault Detect	Sets a tolerance level (as a % of the engineering range) to allow for deviation of the input signal above or below the engineering range before an input failure is detected.
Zero Adjustment	The <i>Zero Adjustment</i> and <i>Span Adjustment</i> parameters enable fine tuning of the inputs to eliminate system errors. Apply a known input value and adjust until the required input value is displayed. Normally, <i>Zero Adjustment</i> is used with input values close to <i>Eng Low</i> (adjustment is performed by applying an offset to the reading). and <i>Span Adjustment</i> is used with values close to <i>Eng High</i> (adjustment is performed by applying a multiplier to the reading).
Span Adjustment	

...Input/Output

Analog Outputs	The analog outputs can be configured to retransmit any analog value and have a configurable range from 0 to 24 mA. Output 1 can also be configured to function as a digital output.
Analog Output 1(2)	Note. Analog Output 2 is available only if an option board is fitted – see pages 16 (CM10), 17 (CM30 and 17 (CM50).
Output Type	Selects the analog or digital output type required (applicable to Analog Output 1 only).
Source	Selects the parameter to be assigned to the output – see Appendix A, page 82 for description of sources.
Elect. Low*	The current output required when the source value is equal to the <i>Eng Low</i> value – see page 43.
Elect. High*	The current output required when the source value is equal to the <i>Eng High</i> value – see page 43.

*Not applicable if *Output Type* is *Digital* or *Source* is *None*.

...Input/Output / ...Analog Outputs / ...Analog Output 1 (2)

Auto Eng Range*	If enabled (<i>On</i>) the <i>Eng High</i> and <i>Eng Low</i> values for the output are set to the engineering range values of the source automatically.
Eng Low*	The minimum engineering range output value.
Eng High*	The maximum engineering range output value.
Polarity**	Sets the polarity of the output signal. If set to <i>Negative</i> , the output is energized when source is inactive. If set to <i>Positive</i> , the output is energized when source is active.

*Not applicable if *Output Type* is *Digital* or *Source* is *None*.

**Not applicable if *Output Type* is *Analog* or *Source* is *None*.

...Input/Output

Digital I/O**Digital IO 1(to 6)****Type**Sets the *Digital IO* to operate as an output or an input.*Off*

No action taken.

*Output*The *Digital IO* operates as an output.*Volt Free*

High input detected when the volt-free switch across the input is closed.

24 Volt

Digital input low < 5V, high > 11V (maximum input 30 V).

TTL

Digital input low < 0.8V, high > 2V.

Output Source

Selects the digital signal to be assigned to the output – see Appendix A, page 82 for description of sources.

...Input/Output / ...Digital I/O / ...Digital IO 1(to 6)**Polarity**

Sets the polarity of the output signal.

*Positive*For an output, the output is high if the source is active.
For an input, the input is active if a high signal is detected.*Negative*For an output the output is high if the source is inactive.
For an input, the input is active if a low signal is detected.**Relays****Relay 1 (to 4)****Source**

Selects the digital signal to be assigned to the relay – see Appendix A, page 82 for description of sources.

Polarity

Sets the polarity of the relay.

Positive

The relay is energized If the source is active.

Negative

The relay is energized If the source is inactive.

7.4 Control

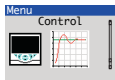

Enables the setpoints, control functions and outputs to be configured.

Loop 1 Setpoints

The controller can configure independent local setpoint values, remote setpoint functionality and limit the absolute values and rate of change of the control setpoint.

Low Limit

The setpoint *Low / High Limit* parameters define the maximum and minimum values for the local and / or remote setpoints. Setpoint limits do not apply in *Manual* control mode with local setpoint tracking enabled.

High Limit

If the setpoint is out of limits when *Auto* control mode is selected, the setpoint value can only be adjusted towards its limits.

No. of Local SP's

Selects the number of independent local (internal) setpoints required. Local setpoints can be selected from the *Operator* level menu or via a digital signal.

Local Setpoint 1(2)

If the value is adjusted in the *Operator* level (see page 23), its value here is also updated.

...Control / ...Loop 1 Setpoints

Track Mode	The local (internal) setpoint can track another value according to the setpoint tracking mode selected.
<i>Off</i>	No tracking.
<i>Local</i>	The local (internal) setpoint tracks the process variable when <i>Manual</i> control mode is selected.
<i>Remote</i>	The local (internal) setpoint tracks the remote (external) setpoint when in <i>Remote Setpoint</i> mode. If the controller is put into <i>Manual</i> control mode the setpoint reverts from <i>Remote</i> to <i>Local</i> . Note. Available only if the template selected has remote setpoint functionality.
<i>Local and Remote</i>	Available only if the template selected has remote setpoint functionality.
RSP Ratio	When the remote (external) setpoint is selected the control setpoint value is: $(\text{ratio} \times \text{remote setpoint input}) + \text{bias}$
RSP Bias	Sets the remote setpoint bias in engineering units – see Appendix A.2, page 82 for description of analog input units.

...Control / ...Loop 1 Setpoints

RSP Fault Action	The action required when a fault occurs with the remote setpoint.
<i>No Action</i>	No fault action.
<i>Local</i>	Selects the local (internal) setpoint mode.
<i>Local Default</i>	Selects the local (internal) setpoint mode and sets its value to the default setpoint.
Default Setpoint	Sets the value required for the local (internal) setpoint under remote setpoint fault conditions.
Ramp Mode	See <i>Basic Level</i> , page 28.
Ramp Rate	See <i>Basic Level</i> , page 28.
Select Sources	Selection of local setpoints and changing the setpoint mode (between local [internal] and remote [external]) can be controlled by digital signals, either from internal digital signals (for example, alarm states) or from external signals via digital inputs (or digital communications) – see Appendix A, page 82 for description of sources.
LSP 1/2 Toggle	The (level-triggered) source required to select either local setpoint 1 (LSP1) or local setpoint 2 (LSP2). A low signal locks the local setpoint as LSP1; a high signal locks it as LSP2.

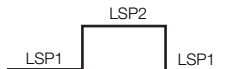

...Control / ...Loop 1 Setpoints / Select Sources

LSP1 (to 2) Select The source required to select local setpoint 1 (LSP1) as the current local setpoint. Selection is made on the rising edge of the digital signal.

Local Select The source required to select local setpoint 1 (LSP1) as the current local setpoint. Selection is made on the rising edge of the digital signal.

Remote Select The source required to select remote setpoint mode.

Loc/Rem Toggle The (level-triggered) source required to select either local or remote setpoint mode. This source is level-triggered.

A low signal locks the controller in local setpoint mode and a high signal locks it in remote setpoint mode. The edge-triggered local and remote selection sources and the front panel keys do not operate when this function is used.

If the remote setpoint fails while selected using this digital selection and the *RSP Fault Action parameter* is not set to *No Action* (see page 51), the mode changes to *Local*.

As soon as the remote setpoint is no longer in a failed state it reverts to Remote mode (if it is still selected by this function).

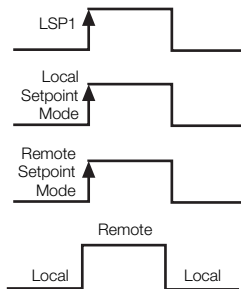

...Control

Loop 1 Control	Configures the basic type of control required and the <i>PID</i> (see page 32) and <i>Autotune</i> (see page 30) settings.
Control Type	Selects the basic type of controller required.
PID	Standard proportional, integral and derivative control.
On/Off	A simple 2-state control. Note. Loop 1 output type must be set to Time Prop – see page 35.
Control Action	If the required controller action is known it can be set using this parameter. Otherwise it can be set to <i>Unknown</i> and <i>Autotune</i> (see page 30) determines and selects the correct action.
<i>Direct</i>	For applications where an increasing process variable requires an increasing output to control it.
<i>Reverse</i>	For applications where an increasing process variable requires a decreasing output to control it.
<i>Unknown</i>	For applications where the control action is not known (run <i>Autotune</i> to set the control action automatically).
On/Off Hysteresis	Refer to <i>Basic Level / On / Off Hysteresis</i> on page 29.
Autotune	Refer to <i>Basic Level / Autotune</i> on page 30.
PID	Refer to <i>Basic Level / PID</i> on page 32.

...Control

Loop 1 Output	Used to set the output limits, tracking rates, slew rates and output action on power failure or process variable failure.
Limits	Note. When used with split output the limits restrict the PID algorithm output (see page 32) before the split output range values are calculated.
Limit Action	Selects when the output limits should be applied (<i>Off, Auto + Manual, Auto Only</i>).
Low/High Limit	Set minimum / maximum controller output in %.
Failure Actions	
Power Recovery	Used to select the default power failure mode required following a power interruption or failure.
<i>Last Mode</i>	The last <i>Power Recovery</i> mode selected.
<i>Man – Last</i>	<i>Manual</i> control mode using the last output before power failure.
<i>Man – 0 %</i>	<i>Manual</i> control mode with output set to 0 %.
<i>Man – 100 %</i>	<i>Manual</i> control mode with output set to 100 %.

...Control / ...Loop 1 Output / ...Failure Actions / ...Power Recovery

<i>Man – Default</i>	<i>Manual</i> control mode with output set to default value.
<i>Auto Mode</i>	<i>Auto</i> control mode with integral term reset.
<i>Auto – Last</i>	<i>Auto</i> control mode with integral term restored to its last value before the power failure.
PV Fail Action	Determines the controller output when the <i>PV</i> (process variable) input fails.
<i>No Action</i>	No action is taken if the <i>PV</i> input fails.
<i>Man – Hold O/P</i>	Puts the controller into <i>Manual</i> control mode and holds the output at its value immediately prior to the <i>PV</i> failure.
<i>Man – Default O/P</i>	Puts the controller into <i>Manual</i> control mode and sets the output to the default output value.
Default Output	This parameter is used in conjunction with <i>Power Recovery</i> (see page 54) and <i>PV Fail Action</i> settings (see above). For split outputs this value refers to the <i>PID</i> algorithm (see page 32) before the split range values are calculated.

...Control / ...Loop 1 Output

A/M Select Sources The selection of *A/M (Auto / Manual)* control modes of operation can be controlled by digital signals; either from internal digital signals (for example, alarm states) or from external signals via digital inputs (or digital communications).

Auto Select The source required to select *Auto* control mode. Selection is made on the rising edge of the digital signal.

Manual 1(2) Select The source required to select *Auto* control mode. Selection is made on rising edge of the digital signal. The output value is set according to *Manual 1(2) Config O/P* (see below).

Manual 1(2) Output Determines the *Manual* output value to be set when the controller is put into *Manual* control mode (see page 6) using *Manual 1(2) Select* source.

Last Auto O/P Holds the output at its value prior to switching to *Manual* control mode.

Man - 0% Sets the output to 0 %.

Man - 100% Sets the output to 100 %.

Config Value Sets the output to the value set in *Manual 2 Config O/P* – see page 57.

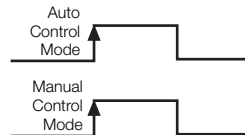

...Control / ...Loop 1 Output / ...A/M Select Sources

**Manual 1(2)
Config O/P** Used when *Manual 1(2) Output* is set to *Config Value*.

A/M Toggle The source required to toggle between *A/M (Auto / Manual)* control modes. When the digital signal is high, the controller is locked in *Manual* control mode (the front panel controls [see page 6] and other digital select signals have no effect). When the digital signal is low *Auto* control mode is selected. When in the low state, either the front panel controls or edge-triggered digital signals can be used to put the controller into *Manual* control mode.

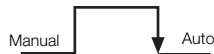

A/M Output Sets the (manual) output value to be set when the controller is put into *Manual* control mode using *A/M Toggle* source.

*Last Auto
O/P* Holds the output at its value prior to switching to *Manual* control mode.

Man - 0% Sets the output to 0 %.

Man - 100% Sets the output to 100 %.

Config Value Sets the output to the value set in *A/M Config O/P*.

**A/M Config
O/P** Used when *A/M Output* is set to *Config Value*.

...Control / ...Loop 1 Output

Slew Rate The output slew rate – restricts the maximum rate of change of the control output.

Function Selects if the output slew rate function is enabled and when it applies.

Off

Up and Down

The *Slew Rate* applies to increasing and decreasing output values.

Up

The *Slew Rate* applies to increasing output values.

Down

The *Slew Rate* applies to decreasing output values only.

Rate The maximum rate of change of the control output (as % / s).

Disable Source The (level-triggered) source required to disable slew rate control of the output. This source is level-triggered.

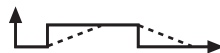

...Control / ...Loop 1 Output

Tracking	Enables the control output to be configured to follow a tracking signal when in <i>Auto</i> control mode. When in <i>Manual</i> control mode, the output can be adjusted by the user as normal. If the slow rate function is enabled, the switching from <i>Manual</i> to <i>Auto</i> is bumpless. If the value set by the tracking signal is different to that set manually, the output ramps to its expected auto value at the speed set in the slow rate. If the <i>Signal Source</i> is set to <i>None</i> , tracking is disabled and the normal <i>PID</i> output (see page 32) is provided as the control output.
Source Signal Source	Sets the source of the signal required to be tracked by the output in <i>Auto</i> control mode. If set to <i>None</i> , output tracking is disabled.
Mode	Selects if the output slow rate function is enabled and when it applies.
<i>In Auto</i>	Control output = tracking signal when in <i>Auto</i> control mode
<i>Auto + OP</i>	Control output = tracking signal + change in <i>PID</i> output, when in <i>Auto</i> control mode.
<i>When Enabled</i>	When enable source is active, control output = tracking signal when in <i>Auto</i> control mode.
<i>When Enabled + OP</i>	When enable source is active, control output = tracking signal + change in <i>PID</i> output, when in <i>Auto</i> control mode.
Enable Source	Sets the digital signal to enable output tracking. Note. Applicable only if <i>Mode</i> = <i>When Enabled</i> or <i>When Enabled + OP</i> .

...Control

Loop 1 Split O/P*

The split output facility enables the *PID* control output (see page 32) to be split into 2 separate outputs. This enables heat / cool and other applications requiring dual outputs to be controlled. The linear relationship between the input from the *PID* algorithm and the 2 outputs is configured using the *Min* and *Max Input/Output* parameters (see below).

When operating with *Split O/P* in *Manual* control mode, manual adjustment is made to the input at the split output block (x axis). By default, the Operator page displays both output values (OP1 and OP2).

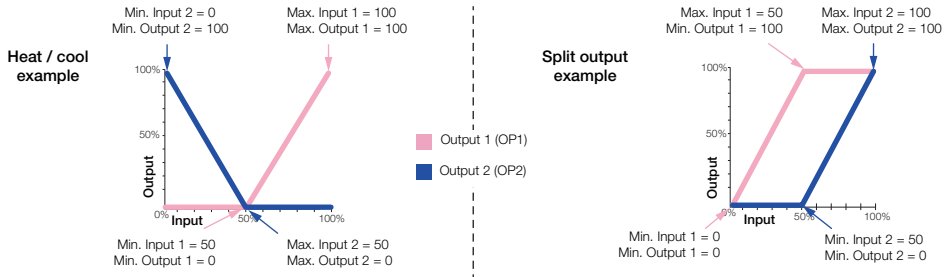

Loop 1 Time Prop See *Basic* level, page 28.

*Applicable only if the output type selected is *Split O/P* (see page 35).

7.5 Process Alarm

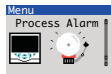

Used to configure up to 8 independent process alarms.

Process Alarm

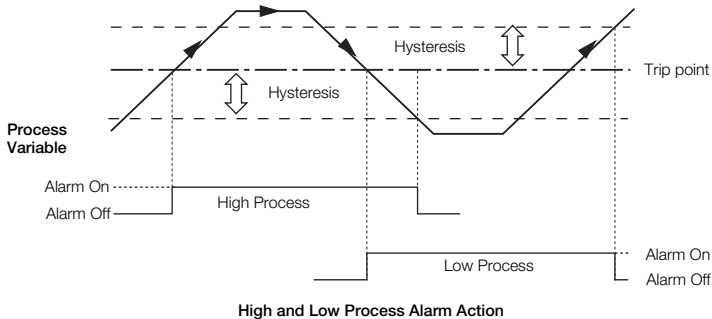

...Process Alarm

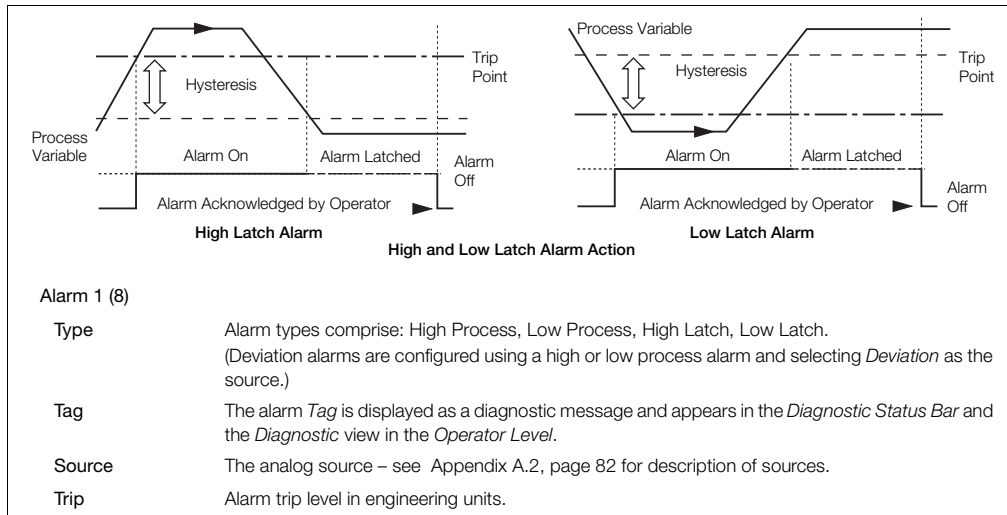

...Process Alarm / ... Alarm 1 (to 8)

Hysteresis	Hysteresis trip level in engineering units. Activated at the alarm trip level but deactivated only when the process variable has moved into the safe region by an amount equal to the hysteresis value – see Process Alarm examples on page 61.
Time Hysteresis	If an alarm trip value is exceeded, the alarm does not become active until the <i>Time Hysteresis</i> value has expired. If the signal goes out of the alarm condition before the <i>Time Hysteresis</i> has expired, the hysteresis timer is reset.
Display Enable	Enables an alarm to be used for control purposes without it appearing as an active alarm state in the <i>Operator Level</i> or <i>Diagnostic</i> view – see page 23.
Acknowledge Source	The source required to acknowledge all active alarms. Acknowledge occurs on rising edge of the digital signal – see Appendix A, page 82 for description of sources.
Enable Source	The source required to enable alarms. If <i>the</i> source is <i>None</i> , alarms are always enabled – see Appendix A, page 82 for description of sources.



7.6 Communication

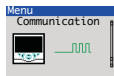

Used to setup communications parameters for the MODBUS / Ethernet communication protocols – see separate User Guide (IM/CM/C-EN).

7.7 Diagnostics

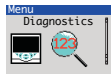

Used to view diagnostic data – see section 7.7.1, page 66 for description of diagnostic messages and recommended corrective action(s).

Diagnostic History

Displays a log of the diagnostic messages generated by the controller. Each diagnostic condition has a classification code conforming to NAMUR NE107.

n = Number of instances of this diagnostic condition

Σ = Total time spent in this diagnostic condition

t_n = Time since the last instance of this diagnostic condition

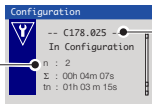

 C = Check Function

 M = Maintenance

 S = Out of Spec

 F = Failure

 C 178.025

Diagnostic priority
Highest value = 250

Internal Code

...Diagnostics

Source Analysis

Analog Sources	Enables the current value of any analog source to be viewed.
Analog Source	Selects the analog signal to be viewed – see section A.2, page 82.
View Value	Displays the value of the analog signal selected.
Digital Sources	Enables the current state of any digital source to be viewed.
Digital Source	Selects the digital signal to be viewed – see section A.1, page 82.
View State	Displays the state of the digital signal selected.
Invalid Sources	Select edit to display any invalid analog or digital sources that are used in the configuration. Reasons for invalid sources include: <ul style="list-style-type: none">■ Hardware not fitted■ Software not fitted■ Digital I/O configured as wrong type■ Alarms not configured■ Math, logic, timer or custom linearizer not configured

7.7.1 Diagnostic Messages

Icon	Number / Message	Possible Cause	Suggested Action
⊗	242.004 (240.005) ADC 1(2) Failed	Temporary or permanent failure of analog to digital converter on the main I/O board.	Cycle power to device. If problem persists replace main I/O board. Contact local service organization.
⊗	250.000 PV 1 Failed	Problem with Input assigned to Loop 1 PV. Broken sensor leads, defective input source or input signal out of permitted range.	Check wiring. Check input source. Check if input signal is outside permitted limits.
⊗	246.002 RSP 1 Failed	Problem with Input assigned to Loop 1 Remote Setpoint. Broken sensor leads, defective input source or input signal out of permitted range.	Check wiring. Check input source. Check if input signal is outside permitted limits.
⊗	222.014 (220.015) CJ 1(2) Failed	Error in Cold junction measurement associated with AIN1. Wiring fault or defective sensor.	Check cold junction device is correctly fitted. Ensure I/P 2(4) is turned off. Replace CJ sensor.
⊗	226.012 DV 1 Failed	Problem with input assigned to Loop 1 disturbance variable. Broken sensor leads, defective input source or input signal out of permitted range.	Check wiring. Check input source. Check if input signal is outside permitted limits.
⊗	230.010 WV 1 Failed	Problem with input assigned to Loop 1 wild variable. Broken sensor leads, defective input source or input signal out of permitted range.	Check wiring. Check input source. Check if input signal is outside permitted limits.

Table 7.1 Diagnostic Messages

Icon	Number / Message	Possible Cause	Suggested Action
⊗	234.008 (232.009) PFB 1(2) Failed	Problem with input assigned to Loop 1 (2) position feedback. Broken sensor leads, defective input source or input signal out of permitted range.	Check wiring. Check input source. Check if input signal is outside permitted limits.
⊗	216.016 NV Error Proc Bd	Failure of non-volatile memory on processor / display board or permanent corruption of its data.	Check all configuration parameters and correct any errors. Acknowledge error. If problem persists contact local service organization.
⊗	214.017 NV Error Main Bd	Failure of non-volatile memory on main board or permanent corruption of its data.	Check calibration of AIN1, AIN2 and AO1. Recalibrate if necessary. Acknowledge error. If problem persists contact local service organization.
⊗	212.018 NV Error Opt Bd 1	Failure of non-volatile memory on option board 1 or permanent corruption of its data.	Recalibrate If necessary. Acknowledge error. If problem persists contact local service organization.
⊗	210.019 NV Error Opt Bd 2	Failure of non-volatile memory on option board 2 or permanent corruption of its data.	Check calibration of AO2. Recalibrate If necessary. Acknowledge error. If problem persists contact local service organization.

Table 7.1 Diagnostic Messages (Continued)





Icon	Number / Message	Possible Cause	Suggested Action
	208.020 NV Error Comm Bd	Failure of non-volatile memory on communications board or permanent corruption of its data.	Acknowledge error. Check communications board is correctly identified by device. If problem persists contact local service organization.
	Config Error	The configuration contains a source that is no longer present or valid.	Check invalid sources in Diagnostics menu – see section 7.7, page 64. Check configuration, check I/O required for configuration is present and correct any illegal use of the invalid signal by changing configuration or fitting additional option cards.
	054.044 Tune Lp1 Fail	Autotune has failed to complete its sequence or has calculated values outside of its permitted range.	Check process response. Consider changing the Autotune dynamic setting – see page 32. Ensure process is stable and repeat autotune. If problem persists tune the loop manually.
	070.040 (066.041) Tuner 1(2) Abort	Autotune has been aborted by the user.	
	078.038 (074.039) Adaptive 1(2) Warn	Parameters calculated by adaptive control have changed by more than the permitted amounts.	Check process for issues that may have caused a large change in its dynamics, for example, a blocked valve. Reset adaptive control. Perform a fresh autotune.

Table 7.1 Diagnostic Messages (Continued)







Icon	Number / Message	Possible Cause	Suggested Action
	086.036 (082.037) Oscillation 1(2)	Abnormal oscillations in the control loop.	Check process. Perform new manual or Autotune.
	094.034 (090.035) Valve 1(2) Sticking	Motorized valve travel time is significantly slower than configured time.	Check valve to identify reason for sticking. Check correct travel time is entered in configuration.
	168.026 (166.027) (164.028) Tuner 1 Phase 1..3	Autotune is in progress – see page 30 for details of each phase.	Autotune can be aborted if required by selecting <i>Manual</i> control mode.
	160.030 (158.031) 156.032) Tuner 2 Phase 1..3	Autotune is in progress – see page 30 for details of each phase.	Autotune can be aborted if required by selecting <i>Manual</i> control mode.
	162.029 (154.033) Tuner 1(2) Pass	Autotune has completed successfully and calculated new control parameters.	Acknowledge diagnostic.
	178.025 In Configuration	The device is currently in the configuration mode.	This is for use with remote access via digital communications.

Table 7.1 Diagnostic Messages (Continued)

7.8 Device Info



Used to display read-only factory-set parameters for the controller.

Instrument Type	The controller's model number (for example, CM30).
I/O Build	The input / output (I/O) configuration.
No. Analog Inputs	The number of analog inputs available.
No. Analog Outputs	The number of analog outputs available.
No. Relays	The number of relays available.
No. Digital I/O	The number of digital inputs / outputs available.
Functionality	The current functional setting of the controller (for example, <i>Single Loop</i>).
Serial No.	The factory serial number.
Hardware Revision	The controller's hardware version number.
Software Revision	The controller's software version number.

8 Templates and Functionality

Notes. Output assignments can be changed in *Input/Output* configuration – see page 41.

8.1 Single Loop / Single Loop with Remote Setpoint

This template provides basic feedback control using three-term PID or On/Off control. The controller output is calculated from the difference between the process variable and the control setpoint. The control setpoint can be a fixed value entered by the user (Local setpoint) or an input from a remote source (remote setpoint).

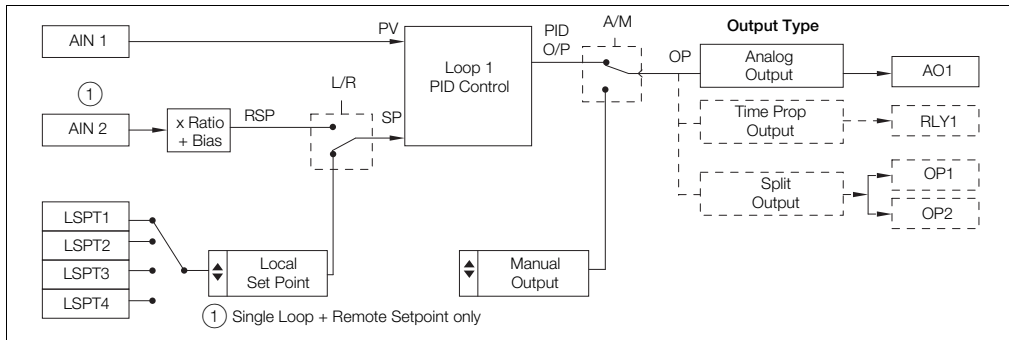

9 PC Configuration

In addition to local configuration via the front panel keys, the controller can be configured from a PC via the infrared port using the ConfigPilot PC configuration software. The controller's infrared port is activated when accessing the following page in the Advanced level:

Advanced>Device Setup>IrDA Configuration>Connect

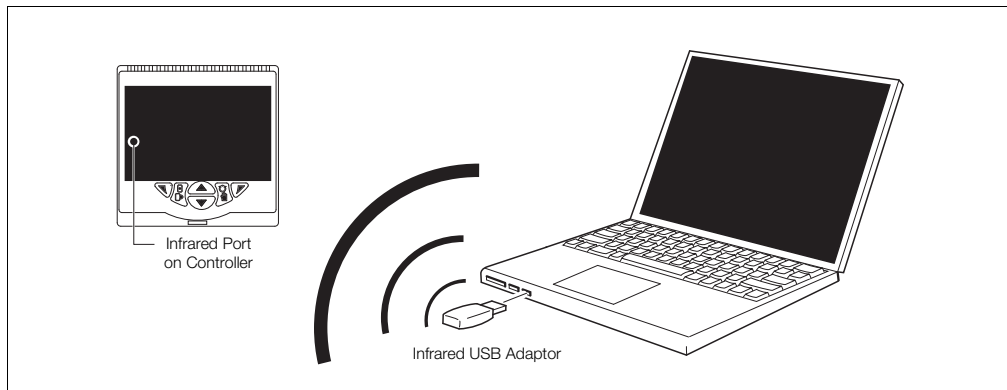

Fig. 9.1 PC Configuration via Infrared Port

10 Specification

Operation

Display

Color 1/4 VGA TFT, liquid crystal display (LCD) with built-in backlight

Language

English, German, French, Italian and Spanish

Operator keypad

CM10	4 tactile membrane keys
CM30 and CM50	6 tactile membrane keys

Security

Password protection

Basic / Advanced	User-assigned password protection (not set at factory)
------------------	---

Standard functions

Control strategies

Base templates	Single loop with local setpoint
	Single loop with remote setpoint
Standard templates	Auto/Manual station (low signal detection)
	Auto/Manual station (digital signal selection)
	Analog backup station (low signal detection)
	Analog backup station (digital signal detection)
	Single indicator / manual loader station
	Dual indicator / manual loader station

Control output types

Current proportioning

Time proportioning

On / Off

Motorized valve with feedback

Motorized valve without feedback

Split output – with combinations of relay, digital output and current outputs

Control parameters

Proportional band * 0.0 to 999.9 %

Integral * 0 to 10000 s

Derivative * 0.0 to 999.9 s

Manual Reset 0.0 to 100.0 %

Setpoints

Local

CM10 2, selectable via digital inputs or front panel

CM30 / CM50 4, selectable via digital inputs or front panel

Remote selectable via digital input or front panel keys

Autotune

On-demand calculation of control settings

Process Alarms

Number 8

Types High / Low process
High / Low latch

Source Fully configurable (for example, PV, analog input, math block inbuilt, OP control loop deviation)

Hysteresis Level and time

Alarm enable Enable / disable of individual alarms via a digital signal

Acknowledgement

Via front panel keys or digital signals

Real-time alarms **

Number 2

Programmable Time
Day
Duration

* 3 sets of PID parameters when used with Gain Scheduling facility

** Functionality level 'Standard' only

Maths blocks *

Number	8
Operators	+, -, ×, / Average, Maximum, Minimum High / Low / Median Select Square root Multiplexer

Delay timers *

Number	2
Programmable	Delay Duration

Logic equations *

Number	8
Elements	15 Per equation
Operators	OR, AND, NOR, NAND, NOT, EXOR

Custom linearizer *

Number	2
Elements	20 Breakpoints

Bank control *

Number of outputs	6
Wear levelling	Rotate or FIFO

* Functionality level 'Standard' only

Analog inputs

Universal process inputs

CM10	1 Standard
CM30 / CM50	2 (1 Standard, 1 optional)
Type	Voltage Current Resistance (ohms) 3-Wire RTD Thermocouple Digital volt-free Digital 24 V Frequency Pulse

Non-universal process inputs

CM10	1 Standard
CM30 / CM50	2 (1 Standard, 1 optional)
Type	Voltage Current Thermocouple Digital volt-free Digital 24 V

Thermocouple types

B, E, J, K, L, N, R, S, T

Resistance thermometer

Pt100

Other linearizations \sqrt{x} , $x^{3/2}$, $x^{5/2}$,**Digital filter**

Programmable 0 to 60 s

Display range

-9999 to 99999

Update rate

125 ms

Common mode noise rejection>120 dB at 50/60 Hz with 300 Ω imbalance resistance**Normal (series) mode noise rejection**

>60 dB at 50/60 Hz

CJC rejection ratio0.05 $^{\circ}\text{C}$ / $^{\circ}\text{C}$ change in ambient temperature**Temperature stability**0.02 % / $^{\circ}\text{C}$ or 2 μV / $^{\circ}\text{C}$ (1 μV / $^{\circ}\text{F}$)**Long term (input) drift**<0.1 % of reading or 10 μV annually**Input impedance**>10 M Ω (millivolts input)10 Ω (mA input)**Inputs**

Thermocouple	Maximum Range $^{\circ}\text{C}$ ($^{\circ}\text{F}$)	Accuracy (% of reading) $^{\circ}\text{C}$ ($^{\circ}\text{F}$)
B ⁺	-18 to 1800 (0 to 3270)	0.1 % or ± 2 $^{\circ}\text{C}$ (3.6 $^{\circ}\text{F}$) (above 200 $^{\circ}\text{C}$ [392 $^{\circ}\text{F}$]) *
E	-100 to 900 (-140 to 1650)	0.1 % or ± 0.5 $^{\circ}\text{C}$ (0.9 $^{\circ}\text{F}$)
J	-100 to 900 (-140 to 1650)	0.1 % or ± 0.5 $^{\circ}\text{C}$ (0.9 $^{\circ}\text{F}$)
K	-100 to 1300 (-140 to 2350)	0.1 % or ± 0.5 $^{\circ}\text{C}$ (0.9 $^{\circ}\text{F}$)
L	-100 to 900 (-140 to 1650)	0.1 % or ± 1.5 $^{\circ}\text{C}$ (2.7 $^{\circ}\text{F}$)
N	-200 to 1300 (-325 to 2350)	0.1 % or ± 0.5 $^{\circ}\text{C}$ (0.9 $^{\circ}\text{F}$)
R ⁺	-18 to 1700 (0 to 3000)	0.1 % or ± 1 $^{\circ}\text{C}$ (1.8 $^{\circ}\text{F}$) (above 300 $^{\circ}\text{C}$ [540 $^{\circ}\text{F}$])
S ⁺	-18 to 1700 (0 to 3000)	0.1 % or ± 1 $^{\circ}\text{C}$ (1.8 $^{\circ}\text{F}$) (above 200 $^{\circ}\text{C}$ [392 $^{\circ}\text{F}$])
T ⁺	-250 to 300 (-400 to 550)	0.1 % or ± 0.5 $^{\circ}\text{C}$ (0.9 $^{\circ}\text{F}$) (above -150 $^{\circ}\text{C}$ [-238 $^{\circ}\text{F}$])

*For B, R, S and T thermocouples, accuracy is not guaranteed below the value stated.

ControlMaster CM10, CM30 and CM50

Universal process controllers, 1/8, 1/4 and 1/2 DIN

10 Specification

RTD	Maximum Range °C (°F)	Accuracy (% of reading)
Pt100	-200 to 600 (-325 to 1100)	0.1 % or ± 0.5 °C (0.9 °F)

Linear Inputs	Standard Analog Input	Accuracy (% of reading)
Millivolts	0 to 150 mV	0.1 % or ± 20 μ V
Milliamps	0 to 45 mA (CM10 and CM30) 0 to 50 mA (CM50)	0.2 % or ± 4 μ A
Volts	0 to 25 V	0.2 % or ± 20 mV
Resistance Ω (low)	0 to 550 Ω	0.2 % or ± 0.1 Ω
Resistance Ω (high)	0 to 10 k Ω	0.5 % or ± 10 Ω
Sample Interval	125 ms per sample	

Digital Inputs	
Type	Volt-free or 24 V
Minimum pulse duration	Analog inputs 1 and 2: <ul style="list-style-type: none">■ Single inputs configured – 250 ms■ Both inputs configured as analog or digital – 500 ms Analog inputs 3 and 4 (not CM10): <ul style="list-style-type: none">■ Single inputs configured – 250 ms■ Both inputs configured as analog or digital – 500 ms Consider analog inputs 1 / 2 and 3 / 4 independently

Frequency input*	
Frequency range	0 to 6000 Hz
1-signal	15 to 30 V
0-signal	-3 to 5 V

*For use with devices with open collector outputs

Outputs**Controls / retransmission outputs**

Number	2 (1 standard, 1 optional)
Type	Configurable as analog or digital pulse
Isolation	Galvanically isolated from the rest of the circuitry, 500 V for 1 minute
Analog range	0 to 20 mA programmable
Load	750 Ω Max.
Accuracy	0.25 % of output or $\pm 10 \mu\text{A}$

Relays

Number	CM10 / CM30: 4 (1 standard, 3 optional) CM50: 4 (2 standard, 2 optional)
Type	CM10, CM30: Standard with changeover contacts. Optional contacts selectable as N/O or N/C (by jumper) CM50: Selectable as N/O or N/C (by jumper)

Contact ratings

CM10:	Relay 1:	5 A, 240 V
	Relays 2, 3, 4:	5 A, 240 V (max. ambient 40 °C (104 °F))
	Relays 2, 3, 4:	2 A, 240 V (max. ambient 55 °C (131 °F))

CM30, CM50: 5 A, 240 V

Update rate 125 ms

Digital input / output

CM10	2 (optional)
CM30 / CM50	6 (2 standard, 4 optional)
Type	User-programmable as input or output Minimum input pulse duration – 125 ms
	<ul style="list-style-type: none"> ■ Input <ul style="list-style-type: none"> – volt-free or 24 V DC – 1-signal: 15 to 30 V – 0-signal: -3 to 5 V – Conforms to IEC 61131-2 ■ Output <ul style="list-style-type: none"> – Open collector output – 30 V, 100 mA max. switched – Conforms to IEC 61131-2
Update rate	125 ms

2-Wire transmitter power supply

CM10	1 (standard)
CM30 / CM50	2 (1 standard, 1 optional)
Voltage	24 V DC
Drive	2 Loops for each transmitter psu, 45 mA max.

Communications

For MODBUS and Ethernet communications see separate User Guide ([IM/CM/C-EN](#)).

IrDA configuration port (standard)

Baud rate	up to 115 kBaud
Distance	up to 1 m (3 ft.)
Functions	firmware upgrade configuration upload / download

EMC

Emissions & immunity

Meets requirements of IEC61326 for an Industrial Environment

Environmental

Operating temperature range

0 to 55 °C (32 to 131 °F)*

Operating humidity range

5 to 95 %RH (non-condensing)

Storage temperature range

-20 to 70 °C (-4 to 158 °F)

*Restrictions may apply, refer to relay specification

Enclosure sealing

Front face	IP66 / NEMA 4X
Rest of enclosure	IP20

Vibration

Conforms to EN60068-2-6

Safety

Approvals and certifications

EN61010-1

cULus

General safety

Pollution category 2

Insulation category 2

Isolation (to inputs)

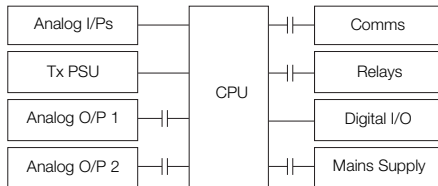

Key

—||— = Isolation

Electrical**Supply ranges**100 to 240 V AC $\pm 10\%$ (90 V min. to 264 V max.) 50 / 60 Hz

10 to 36 V DC (optional)

Power consumption

10 W max.

Power interruption protection

No effect for interrupts of up to 60 ms

Physical**Size**

CM10 50 x 97 x 141 mm (2.0 x 3.8 x 5.5 in.)

CM30 97 x 97 x 141 mm (3.8 x 3.8 x 5.5 in.)

CM50 144 x 76 x 146 mm (5.6 x 3.0 x 5.7 in.)

Weight

CM10 0.38 kg (0.84 lb) approx. (unpacked)

CM30 0.5 kg (1.1 lb) approx. (unpacked)

CM50 0.58 kg (1.3 lb) approx. (unpacked)

Panel cutoutCM10 45 x 92 mm (1.8 x 3.6 in.),
121 mm (4.8 in.) behind panelCM30 92 x 92 mm (3.6 x 3.6 in.),
121 mm (4.8 in.) behind panelCM50 138 x 68 mm (5.4 x 2.7 in.)
123 mm (4.9 in.) behind panel**Case material**

Glass-filled polycarbonate

DS/CM10-EN Rev. O

DS/CM30-EN Rev. P

DS/CM50-EN Rev. N

ControlMaster CM10, CM30 and CM50

Universal process controllers, 1/8, 1/4 and 1/2 DIN

Notes

Notes

Appendix A – Digital and Analog Sources

Note. Numbers in brackets indicate additional parameters, for example, 'Alarm 1(8) Ack. State' indicates that 8 *Alarm Ack. State* parameters are available.

A.1 Digital Sources

Source Name	Description [Comment]
Alarm 1(8) Ack. State	Acknowledged alarm = 0 Unacknowledged alarm = 1
Alarm 1(8) State	Alarm state
Anlg IP 1(4) Fail	Active input failure (when the signal detected at the analog input is outside the fault detect level specified during configuration)
AO1(2) Loop Break	Analog output
IP 1(4) Digital State	Input 1(4) digital state
Loop 1 SP Mode	Setpoint mode selected 0 = Local, 1 = Remote
Loop 1 Auto Mode	Automatic control mode 1 = Setpoint selected
Loop 1 LSP 1(4) State	Local setpoint state
Loop 1 Manual Mode	Manual control mode 1 = Manual

Source Name	Description [Comment]
Loop 1 TP OP1	Time proportioning output
Softkey Toggle	Front panel soft key toggles the source's state
Softkey Edge	Front panel soft key sets the source active on key press

A.2 Analog Sources

Source Name	Description
Anlg IP 1 (4)	Analog input
Loop 1 Control OP	Control output value
Loop 1 Deviation	Loop 1 deviation
Loop 1 LSP	Local setpoint loop
Loop 1 PV	Loop 1(2) process variable
Loop 1 SP	Loop control setpoint
Loop 1 Split OP1	Loop 1 split output

Appendix B – Configuration Error Codes

Configuration errors are generated when a signal assigned as a source for something has failed. Configuration errors are displayed as numerical codes and a description of each code is shown in the following tables:

Error Code	Error Description
1	Analog Input Value A1 (I/P 1)
2	Analog Input Value A2 (I/P 2)
3	Analog Input Value B1 (I/P 3 – CM50)
4	Analog Input Value B2 (I/P 4 – CM50)
5	Analog Input Value C1 (I/P 3 – CM30)
6	Analog Input Value C2 (I/P 4 – CM30)
9	Setpoint Selected LSPT Value 1
10	Setpoint Contrl SP Value 1
11	Setpoint Selected Ratio Value 1
12	Setpoint Selected Bias Value 1
13	Setpoint Actual Ratio Value 1
14	Setpoint Selected LSPT Value 2
15	Setpoint Contrl SP Value 2

Error Code	Error Description
16	Setpoint Selected Ratio Value 2
17	Setpoint Selected Bias Value 2
18	Setpoint Actual Ratio Value 2
42	Control Output Value 1
43	Control Output Value 2
44	Dual Output Loop 1 Value 1
45	Dual Output Loop 1 Value 2
46	Dual Output Loop 2 Value 1
47	Dual Output Loop 2 Value 2
48	Mot Valve Output 1
49	Mot Valve Output 2
50	PV Maximum Value 1
51	PV Minimum Value 1
52	PV Average Value 1
53	Volume Value 1
54	PV Maximum Value 2

Error Code	Error Description
55	PV Minimum Value 2
56	PV Average Value 2
57	Volume Value 2
58	Customer Linearizer Value 1
59	Customer Linearizer Value 2
60	Profile User Value 1
61	Profile User Value 2
62	Mot Valve Position 1
63	Mot Valve Position 2
64	template Block PV Value 1
65	Template Block PV Value 2
66	Template Block Deviation Value 1
67	Template Block Deviation Value 2
68	Template Block Feedforward Value 1
69	Template Block Feedforward Value 2

ControlMaster CM10, CM30 and CM50

Universal process controllers, 1/8, 1/4 and 1/2 DIN

Appendix B – Configuration Error Codes

Error Code	Error Description
70	Analogue Input Fail State A1
71	Analogue Input Fail State A2
72	Analogue Input Fail State B1
73	Analogue Input Fail State B2
74	Analogue Input Fail State C1
75	Analogue Input Fail State C2
84	Custom Linearizer Fail State 1
85	Custom Linearizer Fail State 2
94	Analog Input State A1 (I/P 1)
95	Analog Input State A2 (I/P 2)
96	Analog Input State B1 (I/P 3 – CM50)
97	Analog Input State B2 (I/P 4 – CM50)
98	Analog Input State C1 (I/P 3 – CM30)
99	Analog Input State C2 (I/P 4 – CM30)
100	Setpoint Remote Mode State 1
101	Setpoint LSPT 1 Selected State 1
102	Setpoint LSPT 2 Selected State 1

Error Code	Error Description
103	Setpoint LSPT 3 Selected State 1
104	Setpoint LSPT 4 Selected State 1
105	Setpoint Remote Mode State 2
106	Setpoint LSPT 1 Selected State 2
107	Setpoint LSPT 2 Selected State 2
108	Setpoint LSPT 3 Selected State 2
109	Setpoint LSPT 4 Selected State 2
110	Digital Input State 1
111	Digital Input State 2
112	Digital Input State 3
113	Digital Input State 4
114	Digital Input State 5
115	Digital Input State 6
131	Logic Equation Result 1
132	Logic Equation Result 2
133	Logic Equation Result 3
134	Logic Equation Result 4
135	Logic Equation Result 5
136	Logic Equation Result 6
137	Logic Equation Result 7

Error Code	Error Description
138	Logic Equation Result 8
139	Real Time Alarm State 1
140	Real Time Alarm State 2
141	Alarm State 1
142	Alarm Ack State 1
143	Alarm State 2
144	Alarm Ack State 2
145	Alarm State 3
146	Alarm Ack State 3
147	Alarm State 4
148	Alarm Ack State 4
149	Alarm State 5
150	Alarm Ack State 5
151	Alarm State 6
152	Alarm Ack State 6
153	Alarm State 7
154	Alarm Ack State 7

ControlMaster CM10, CM30 and CM50

Universal process controllers, 1/8, 1/4 and 1/2 DIN

Appendix B – Configuration Error Codes

Error Code	Error Description
155	Alarm State 8
156	Alarm Ack State 8
157	Time Prop State 1
158	Time Prop State 2
159	Time Prop State 3
160	Time Prop State 4
161	Control O/P Auto State 1
162	Control O/P Manual State 1
163	Control O/P Track Status 1
164	Control O/P Auto State 2
165	Control O/P Manual State 2
166	Control O/P Track Status 2
167	Analog O/P Loop break A1
168	Analog O/P Loop break B1
177	Delay Timer State 1
178	Delay Timer State 2
188	Profiler Timed Event
189	Toggle Signal
190	Edge Signal

Appendix C – Analog Input (Engineering) Units

Unit	Description
%	%
% sat	% saturation
%dO2	% dissolved oxygen
%HCl	% hydrochloric acid
%N2	% nitrogen
%O2	% oxygen
%OBS	% obscuration
%RH	% relative humidity
A	amps
bar	bar
CUMEC	cubic metre per second
deg C / F	degrees Celsius / Fahrenheit
Feet	imperial feet
ft ³ /d, ft ³ /h, ft ³ /m, ft ³ /s	cubic feet per day, hour, minute, second.
FTU	formazine turbidity units
g/d, g/h, g/l	grams per day, hour, liter

Unit	Description
gal/d (UK)	imperial gallons per day
gal/d (US)	US gallons per day
gal/h (UK) / (US)	imperial / US gallons per hour
gal/m, s (UK) / (US)	imperial / US gallons per minute, second.
Hz	hertz
Inches	imperial inches
Kelvin	degrees Kelvin
kg/d, kg/h, kg/m	kilograms per day, hour, minute.
kg/s	kilograms per second
kHz	kilohertz
l/d, l/h, l/m, l/s	liters per day, hour, minute, second.
lb/d, lb/h, lb/m, lb/s	pounds per day, hour, minute, second.
m WG	meters water gauge
m ³ /d, m ³ /h, m ³ /m, m ³ /s	cubic meters per day, hour, minute, second.
mbar	millibar
mg/kg	milligrams per kilogram

ControlMaster CM10, CM30 and CM50

Universal process controllers, 1/8, 1/4 and 1/2 DIN

Appendix C – Analog Input (Engineering) Units

Unit	Description
Mgal/d (UK)	imperial mega gallons per day
Mgal/d (US)	US mega gallons per day
mho	conductance
MI/d, MI/h	megaliters per day, hour.
ml/h, ml/m	milliliters per hour, minute.
MI/s	megaliters per second
mS/cm, mS/m	milliSiemens per centimeter, meter
mV	millivolts
MV	megavolts
NTU	nephelometric turbidity units
pb	parts per billion
pH	potential Hydrogen
pm	parts per million
psi	pounds per square inch
S	Siemens
SCFM	standard cubic feet per minute

Unit	Description
T/d, T/h, T/m	metric tonnes per day, hour, minute.
T/s	metric tonnes per second
ton/d, ton/h, ton/m, ton/s	imperial tons per day, hour, minute, second.
ug/kg	micrograms per kilogram
uS/cm, uS/m	microSiemens per centimeter / meter
uV	microvolts

Appendix D – Output Type Assignments

Output Type	AO 1	AO 2	DIO 1	DIO 2	RLY1	RLY2	RLY3	RLY4
Analog	OP	PV			ALM 1	ALM 2	ALM 3	ALM 4
Time Proportioning	PV	SP			OP	ALM 1	ALM 2	ALM 3
Split Output Analog / Relay	OP 1	PV			OP 2	ALM 1	ALM 2	ALM 3
Split Output Analog / Digital	OP 1	PV	OP 2		ALM 1	ALM 2	ALM 3	ALM 4
Split Output Relay / Relay	PV	SP			OP 1	OP 2	ALM 1	ALM 2
Split Output Relay / Digital	PV	SP	OP 2		OP 1	ALM 1	ALM 2	ALM 3
Split Output Digital / Relay	PV	SP	OP 1		OP 2	ALM 1	ALM 2	ALM 3
Split Output Digital / Digital	PV	SP	OP 1	OP 2	ALM 1	ALM 2	ALM 3	ALM 4
Split Output Analog / Analog	OP 1	OP 2			ALM 1	ALM 2	ALM 3	ALM 4

... *Advanced Level

Refer to Section 7.5, page 61

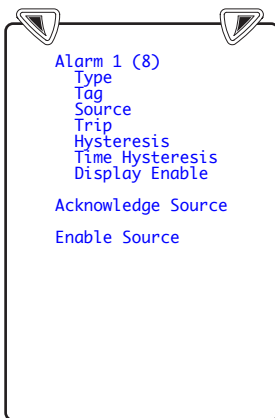
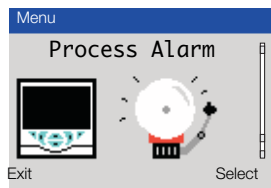

Refer to Section 7.6, page 63

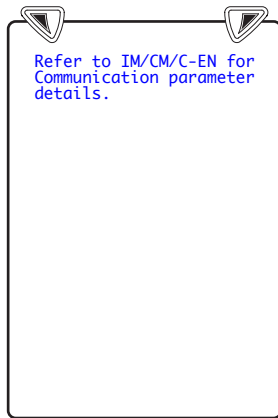
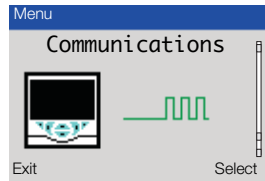

Refer to Section 7.7, page 64

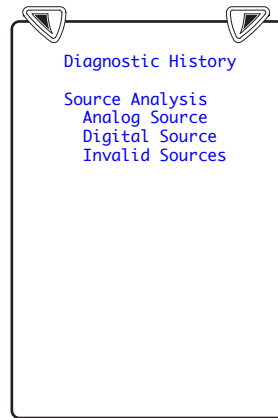
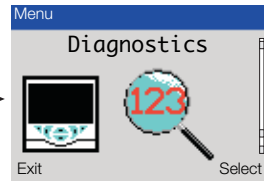

Refer to Section 7.8, page 70

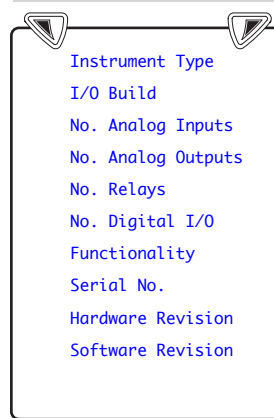
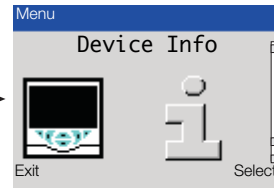

*When in Advanced Level (configuration) mode, press and hold the  key to return to the standard Operator page – see Fig. 3.1, page page 6

Sales



Service



Software



ABB Limited

Measurement & Analytics

Howard Road, St. Neots
Cambridgeshire, PE19 8EU
UK

Tel: +44 (0)1480 475 321

Fax: +44 (0)1480 217 948

Email: instrumentation@gb.abb.com

ABB Inc.

Measurement & Analytics

125 E. County Line Road
Warminster

PA 18974

USA

Tel: +1 215 674 6000

Fax: +1 215 674 7183

abb.com/measurement

We reserve the right to make technical changes or modify the contents of this document without prior notice. With regard to purchase orders, the agreed particulars shall prevail. ABB does not accept any responsibility whatsoever for potential errors or possible lack of information in this document.

We reserve all rights in this document and in the subject matter and illustrations contained therein. Any reproduction, disclosure to third parties or utilization of its contents – in whole or in parts – is forbidden without prior written consent of ABB.
© ABB 2019