



Controller N480D

UNIVERSAL CONTROLLER – INSTRUCTIONS MANUAL – V5.0x E

SAFETY SUMMARY

The symbols below are used on the equipment and throughout this document to draw the user's attention to important operational and safety information.

CAUTION: Read complete instructions prior to installation and operation of the unit.	CAUTION or WARNING: Electrical Shock Hazard

All safety related instructions that appear in the manual must be observed to ensure personal safety and to prevent damage to either the instrument or the system. If the instrument is used in a manner not specified by the manufacturer, the protection provided by the equipment may be impaired.

INSTALLATION

The controller must be installed on a panel with a square opening with the specified dimensions. In order to fasten to the panel, remove the clamps from the controller, introduce the controller in the panel's opening through the front and put the clamps back on the body of the controller through the rear side of the panel. Firmly press the clamps in order to fasten the controller to the panel.

The entire internal part of the controller can be removed from its housing from the front of the panel, without needing to remove the housing or clamps, or undo the connections. To extract the controller from its housing, hold it from the front and pull.

Fig. 1 shows the electrical terminals of the controller.

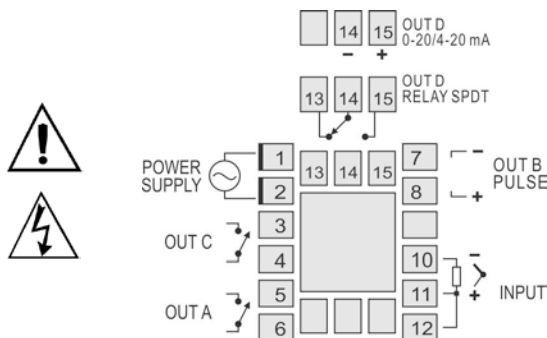

Fig. 1 - Electrical connections of the controller

Thermocouples must be connected between pins 10 and 11. The extension cable positive must be connected to terminal number 11.

Pt100 type sensors must be connected in 3 wires to terminals 10, 11 and 12. For Pt100 in 2 wires, terminals 11 and 12 must be interconnected. For adequate compensation of the cable length, the conductors of this cable must have the same section (gauge).

RESOURCES

INPUT

Table 1 shows the types of temperature sensors accepted by the controller and the respective code used to configure the controller.

TYPE	CODE	RANGE
J	tc J	Range: -110 to 950 °C (-166 to 1742 °F)
K	tc K	Range: -150 to 1370 °C (-238 to 2498 °F)
T	tc t	Range: -160 to 400 °C (-256 to 752 °F)
N	tc n	Range: -270 to 1300 °C (-454 to 2372 °F)
R	tc r	Range: -50 to 1760 °C (-58 to 3200 °F)
S	tc S	Range: -50 to 1760 °C (-58 to 3200 °F)
B	tc b	Range: 400 to 1800 °C (752 to 3272 °F)
E	tc E	Range: -90 to 730 °C (-130 to 1346 °F)
Pt100	Pt	Range: -199.9 to 850 °C (-328 to 1562 °F)

Table 1 - Types of sensors accepted by the controller

CONTROL OUTPUTS AND ALARM (OUTA, OUTB, OUTC AND OUTD)

The controller can have 2, 3 or 4 outputs, which can be configured as control outputs or alarm outputs. These outputs are identified on the rear panel of the controller as OUTA, OUTB, OUTC and OUTD.

The output type (control or alarm) is defined in the controller's configuration. The output configuration is individual and defined in the **outA**, **outB**, **outC**, and **outD** parameters respectively.

Output control is the output intended to control the process temperature. It is possible to configure different outputs as the control output, however, when the **OUTD** output is configured as the **Analog Output Control**, the other control outputs are disabled.

The output control is **always off** when the "Error" message is shown on the controller's display, signaling a process failure, defect in the sensor or connection error.

Alarm outputs are used for signaling and/or safety of the process. For outputs defined as alarm output, it is also necessary to define the alarm function (see the **Alarm Function Description** item of this manual).

USB INTERFACE



The USB interface is used for CONFIGURING or MONITORING the controller. The **NConfig** software must be used for the configuration. It makes it possible to create, view, save and open configurations from the equipment or files in your computer. The tool for saving and opening configurations in files makes it possible to transfer configurations between pieces of equipment and to make backup copies. For specific models, the **NConfig** software also makes it possible to update the firmware (internal software) of the controller through the USB.

For MONITORING purposes you can use any supervisory software (SCADA) or laboratory software that supports the MODBUS RTU communication on a serial communications port. When connected to the USB of a computer, the controller is recognized as a conventional serial port (COM x). Use the **NConfig** software or consult the **DEVICE MANAGER** in the Windows CONTROL PANEL to identify the COM port that was assigned to the controller. Consult the mapping of the

MODBUS memory in the documentation of your supervisory software to conduct the MONITORING process.

Follow the procedure below to use the USB communication of the equipment:

1. Download the **NConfig** software from our website and install it on your computer. The USB drivers necessary for operating the communication will be installed together with the software.
2. Connect the USB cable between the equipment and the computer. The controller does not have to be connected to a power supply. The USB will provide enough power to operate the communication (other equipment functions cannot operate).
3. Open the **NConfig** software, configure the communication and start recognition of the device.

 	<p>The USB interface IS NOT SEPARATE from the signal input (PV) or the controller's digital inputs and outputs. It is intended for temporary use during CONFIGURATION and MONITORING periods. For the safety of people and equipment, it must only be used when the piece of equipment is completely disconnected from the input/output signals. Using the USB in any other type of connection is possible but requires a careful analysis by the person responsible for installing it.</p>
--	---

CONFIGURATION AND OPERATION

Prior to first operation the controller should be fully configured. The user must set basic parameters as temperature type (**TYPE**), the desired control set point (**SP**), the alarms set points (**ISP** and **RSPP**), etc.

The configuration can be performed directly on the controller or through the USB interface. The **NConfig** software (free) is the configuration management tool. Connected to the USB of a *Windows* computer, the controller is recognized as a serial communications port (COM) running with a Modbus RTU protocol.

Through the USB interface, even if disconnected from the power supply, the configuration performed in a piece of equipment can be saved in a file and repeated in other pieces of equipment that require the same configuration.

PARAMETERS FLOW CHART

The programming parameters are organized in 5 different cycles (parameter groups):

- Operation cycle
 - Tuning cycle
 - Program cycle
 - Input cycle
 - Calibration cycle

When Turned On, the controller displays the first screen of the Operation Cycle. This screen shows on the red display (top), the measured temperature value (PV) and also the **Set Point** value of the process (desired temperature for the process) on the green display (bottom). During operation, the controller continues showing this screen. In order to access other screens of this cycle, just press **P**.

All other Cycles are accessed when changes are required to the controller's configuration. In order to access these cycles just **hold down** the **P** key for approximately three seconds. After this time, the controller displays the first parameter of the next cycle (Tuning Cycle). Holding the key down for three seconds, the next cycle (Input Cycle) is also accessed.

Release the **P** key in the desired cycle. Press the **P** key again to access all other parameters of this cycle. The **◀** key allows to return parameters within the cycle.

The upper display shows the parameter and the lower display shows the value of this parameter. The **▲** and **▼** keys allow the operator to change the value of the shown parameter.

After accessing the last parameter of the cycle, the controller returns to the Operation cycle, indicating the temperature process and SP. With the keyboard inactive for more than 20 seconds, the controller also returns to the Operation cycle.

The value of the changed parameter is saved to permanent memory and used by the controller when going to the next parameter, or if no key is pressed within 20 seconds.

PROTECTION OF CONFIGURATION

The controller allows to protect the configuration elaborated by the user, avoiding unauthorized changes. The parameter **Protection (Prot)**, in the Calibration cycle, determines the protection strategy, limiting the access to particular cycles, as shown by the table below.

Protection Level	Protected Cycles
1	Only the Calibration cycle is protected.
2	Input and Calibration cycle.
3	Program, Input and Calibration cycle.
4	Tuning, Program, Input and Calibration cycle.
5	Operation (except SP), Tuning, Program, Input and Calibration cycle.
6	All cycles are protected.

Table 2 – Levels of Protection for the Configuration

Access Password

The protected cycles, when accessed, request the user to provide the **Access Password** for granting permission to change the configuration of the parameters on these cycles.

The prompt **PASS** precedes the parameters on the protected cycles.

If no password is entered, the parameters of the protected cycles can only be visualized.

The Access Password is defined by the user in the parameter Password Change (**PASC**), present in the Calibration cycle.

The new controllers leave the factory with the access password defined as 1111.

Protection of the access password

The controller provides a security system that helps prevent input of numerous passwords trying to get the correct password. When 5 invalid passwords in a row are identified, the controller stops accepting passwords for 10 minutes.

Master Password

The Master Password is intended for allowing the user to define a new password in the event of it being forgotten. The Master Password doesn't grant access to all parameters, only to the Password Change parameter (**PASC**). After defining the new password, the protected parameters may be accessed (and modified) using this new password.

The master password is made up by the last three digits of the serial number of the controller **added** to the number 9000.

As an example, for the equipment with serial number 07154321, the master password is 9 3 2 1.

OPERATION CYCLE

TEMPERATURE INDICATION Control Set Point	<p>Temperature indication (PV) and control set point - When turned on, the controller indicates the process temperature on the upper display. The lower display shows the SP value, which is the desired temperature for the process.</p>
rPE Rate	<p>Temperature increase rate. It allows the user to define the increase or decrease characteristic of the process temperature, the current value to the value programmed in SP. The rate is defined in Degrees per minute. It is adjustable from 0.0 to 100.0 °C per minute.</p> <p>It is available when the Rate option is selected in the PrTY parameter of the Input cycle.</p>

t SP	Cycle Time: Time interval in minutes , that the process must remain in the temperature defined in SP. Adjustable from 0 to 9999. It is available when the Rate option is selected in the Pr.tY parameter of the Input cycle.
E Pr <i>Enable Program</i>	Program Execution – It determines the cycle and ramp program execution. YES Executes program no Does not execute program With enabled outputs (run= YES), the selected program immediately enters in execution. It is available when the Pr option is selected in the Pr.tY parameter of the Input cycle.
run Run	Screen that enables or disables action of the controller over the process. It acts as a switch, turning the controller on or off. YES Outputs enables. no Outputs not enabled.

TUNING CYCLE

Autun <i>Auto tune</i>	AUTO-TUNE: It enables automatic tuning of the PID parameters (Pb, Ir, dt). See chapter Auto tuning of PID Parameters herein for more details. no Automatic tuning off YES Execute automatic tuning.
Pb <i>Proportional band</i>	PROPORTIONAL BAND: Value of the term P of the control mode PID. In percentage of the maximum span of the input type. When set to zero (0), control action is ON/OFF. Adjust of between 0 and 500.0 %.
Ir <i>Integral rate</i>	INTEGRAL RATE: Value of the term I of the control mode PID, in repetitions per minute. This constant is not used when controller is set to ON/OFF action (Pb=0). Adjustable between 0.00 and 55.20.
dt <i>derivative time</i>	DERIVATIVE TIME: Value of the term D of the control mode PID, in seconds. This constant is not used when controller is set to ON/OFF action (Pb=0). Adjustable between 0 and 250.
Ct <i>Cycle time</i>	CYCLE TIME: Pulse Width Modulation (PWM) period in seconds. This constant is not used when controller is set to ON/OFF action (Pb=0). Adjustable between 0.5 and 99.99
HYSt <i>HYsterisis</i>	CONTROL HYSTERESIS: Is the hysteresis for ON/OFF control (set in temperature units). This parameter is only used when the controller is in ON/OFF mode (Pb=0).
A 1SP A2SP <i>Alarm SP</i>	SETPOINT for Alarm 1 and 2: Tripping point for alarm 1 and 2.

PROGRAM CYCLE

Ptol <i>Program Tolerance</i>	Maximum admitted deviation of PV with respect to SP. If exceeded, the program execution is suspended (the internal timer freezes) until the deviation be returns back within the defined tolerance. The value 0 (zero) disables the function.
PSP0 PSP9 <i>Program SP</i>	Program SP's, 0 to 9: Group of 10 values of SP that define the Ramp and Soak profile segments.
PE1 PE9 <i>Program Time</i>	Time intervals of the program segments. It defines the duration in minutes , of each of the 9 program segments. Configurable between 0 and 9999 minutes.

PE1 PE9 <i>Program event</i>	Program Segment Alarm (Event Alarm). Parameters that define the alarm must be activated during the execution of a certain program segment: oFF Do not activate alarm in this segment. A1 Activate alarm 1 when program reaches this segment. A2 Activate alarm 2 when program reaches this segment. A1A2 Activate alarms 1 and 2 when program reaches this segment. The alarms chosen must have its function configured as " rS ".
rPEP <i>Repeat Program</i>	It determines the number of times the program must be REPEATED, besides the initial execution. Configurable between 0 and 9999 times. After the last execution, all controller outputs are turned off (RUN = OFF).

INPUT CYCLE

TYPE <i>TYPE</i>	INPUT TYPE: Selects the input signal type to be connected to the process variable input. Refer to Table 1 for the available options. This must be the first parameter to be configured.
dPPo <i>Decimal Point</i>	DECIMAL POINT. Defines the decimal point position.
unit <i>unit</i>	UNIT: Defines the indication unit in Celsius or Fahrenheit C Degrees Celsius (°C); F Degrees Fahrenheit (°F);
Act <i>Action</i>	CONTROL ACTION: rE Reverse action. Generally used for heating. d Ir Direct action. Generally used for cooling.
outA outB outC outD	OUTA, OUTB, OUTC and OUTD function: oFF Output not used CtL Output defined as control output A1 Output defined as alarm output 1 A2 Output defined as alarm output 2 C.020 Output defined as control output 0-20 mA (only for OUTD) C.420 Output defined as control output 4-20 mA (only for OUTD)
SPLL <i>SP Low Limit</i>	SETPOINT LOW LIMIT: Selects minimum adjustment for parameters relative to the SP (SP, A1SP, A2SP).
SPHL <i>SP High Limit</i>	SETPOINT HIGH LIMIT: Selects maximum adjustment for parameters relative to the SP (SP, A1SP, A2SP).
oFFS <i>OFFSet</i>	OFFSET FOR PV: Parameter that allows to add a value to PV to generate an indication displacement.
A1Fu A2Fu <i>Alarm Function</i>	ALARM FUNCTION 1 AND 2: See Table 4 for description of functions and code to be programmed in these screens.
A1Hy A2Hy <i>Alarm HYsterisis</i>	ALARM HYSTERESIS 1 AND 2: Defines the difference between the measured value when the alarm is activated and the value that is deactivated.
A1bL A2bL <i>Alarm Blocking</i>	Initial Alarm block: YES Enables initial block no Does not enable initial block

Pr.ty Program Type	Type of program to be adopted by controller:
	nonE Does not adopt any type of program
	rAtE Adopts ramp to cycle function
	Pr.cU Adopts complete Ramp and Cycle program.

CALIBRATION CYCLE

All types of input and output are calibrated at the factory. If recalibration is required, it must be performed by a specialist. If this cycle is accessed accidentally, pass through all parameters without making changes to their values.

PRSS	Password. Input of the Access Password. This parameter is presented before the protected cycles. See item Protection of Configuration .
InLC	Input Low Calibration. Enter the value corresponding to the low scale signal applied to the analog input.
InHC	Input High Calibration. Enter the value corresponding to the full scale signal applied to the analog input.
OutLC	Output Low Calibration. Enter of the value measured at the analog output.
OutHC	Output High Calibration. Enter of the value measured at the analog output.
rStr	Restore. Restores the factory calibration for all input, analog output and remote SP, disregarding modifications carried out by the user.
CJ	Cold Junction. Adjusts the of cold junction temperature value.
PRSC	Password. Allows defining a new access password, always different from zero.
Prot	Protection. Sets up the Cycle of Protection. See Table 2.

TYPE OF ADOPTED PROGRAM

Two forms of program execution are available in the controller. The Program Type (**Pr.ty**) parameter allows user to choose between **Ramp to Cycle (rAtE)** and a complete Ramp and Cycle program (**Pr**). User can also choose to not execute any type of program (**nonE**).

PROGRAMS OF RAMP AND SOAK

Available when the **rAtE** option in the **Pr.ty** parameter is selected. The controller allows the process temperature to vary gradually from an initial value until a specified final value, determining a Ramp-like behavior. The initial value of the Ramp will always be the process initial temperature (PV). The final value will always be the value defined in SP. User determines the increase (or decrease) speed of the ramp in the **rAtE** parameter, which defines a temperature variation rate in **degrees per minute**. In order to disable the Ramp function, program the value **0.0**. When the SP value is reached, the controller starts to control the process in SP (cycle) by an interval of time or indefinitely. The **t SP** parameter, adjustable between 0 and 9999 minutes, determines the cycle duration. At the end of the cycle, the control is disabled (**run = no**) and all outputs are turned off. With value **0** in **t SP** the control continues indefinitely without time limit. As alarm can be associated at the end of the cycle. The **End.t** Alarm Function determines that an alarm is activated at the end of the cycle. Valid only with **t SP ≠ 0**.

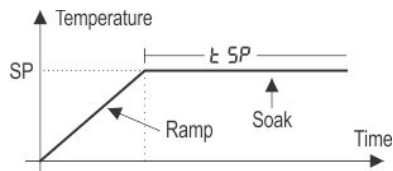

Fig. 2 - Level Ramp Function

Upon returning from a power failure, the controller automatically restarts the execution of the Ramp to Level function. If the PV value is smaller than the SP value, the Ramp restarts at this point until it reaches SP. If the temperature is equal to SP, Level execution is restarted.

COMPLETE LEVEL AND RAMP PROGRAM

Available when the **Pr** option is selected in the **Pr.ty** parameter. The controller allows to elaborate one temperature ramp and level program. This program is created from the SP value definition and time intervals, defining up to nine (9) program segments. The figure below shows a program model with 9 segments:

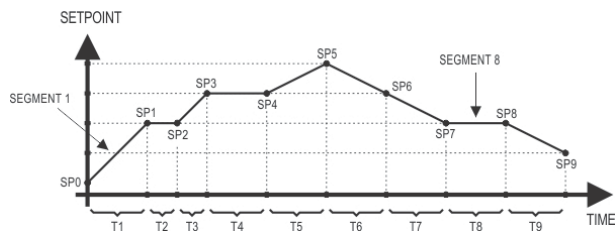

Fig. 3 - Example of a ramp and level program

The program created is permanently stored in the controller's memory. It can be modified freely, executed when necessary and repeated as often as necessary.

In order to execute a program:

- 1- Turn off outputs (**run= no**);
- 2- Enable execution of parameter **EPPr= YES**;
- 3- Trigger start turning on outputs: (**run= YES**).

Once a program is initiated, the controller starts to automatically generate the SP values defined for each program segment. SP adjustment in the indication screen remains blocked.

PROGRAM TOLERANCE FUNCTION - Ptol

The **"Ptol"** program tolerance program defines the maximum error limit between the PV and SP values during program execution. If this limit is exceeded, the timing of the segment (Pt1...Pt9) is interrupted until the error is within the established tolerance. With a value > 0, the user indicates in the program that priority must be given to PV regarding the determined time values.

If zero tolerance (**Ptol = 0**) is programmed, the controller executes the program defined without considering eventual errors between PV and SP. Thus, the user defines that the priority be given to the program execution time.

PROGRAMS WITH FEW SEGMENTS

In order to execute a program with a smaller number of segments, just program 0 (zero) for the time interval that follows the last segment of the desired program.

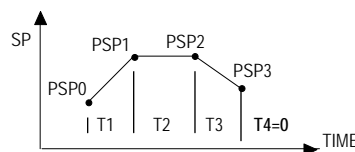

Fig. 4- Example of a program with only 3 segments

SUCCESSIVE REPETITIONS OF A PROGRAM

The elaborated program can be repeated several times, always restarting immediately after each execution.

The **rPEP** (rePeat Program) parameter, in the Program cycle, configures the number of times the program must be **REPEATED**. It determines the number of executions beyond the initial execution.

With zero (0), the program is executed only one time. It will not be repeated.

Important: After the last execution of the program, all controller outputs are turned off and the RUN parameter changes to OFF.

AUTO TUNING OF PID PARAMETERS

During the **automatic tuning** the process is controlled in ON / OFF mode in the programmed SP - the Ramp to Level function is disabled. The **automatic tuning** may take many minutes to the concluded, particularly in slow processes. Some recommendations for the automatic tuning process are:

- Program SP to a value close to the point at which the process will operate after tuning.
- Enable automatic tuning on the **"Atun"** screen by selecting **YES**.
- Program the value **YES** on the **"run"** screen.

The **"TUNE"** indicator on the display stays lit until the completion of the **automatic tuning** process.

During the execution of automatic tuning, large oscillations can be induced in the process around the set point. Check if the process supports these oscillations.

If the automatic tuning does not result in a satisfactory control, refer to **Table 2** for guidelines on how to correct the behavior of the process.

PARAMETER	VERIFIED PROBLEM	SOLUTION
Proportional Band	Slow answer	Decrease
	Great oscillation	Increase
Rate of Integration	Slow answer	Increase
	Great oscillation	Decrease
Derivative Time	Slow answer or instability	Decrease
	Great oscillation	Increase

Table 3 - Guidance for manual adjustment of the PID parameters

ALARMS FUNCTIONS

The minimum and maximum alarms are used to signalize extreme temperature values. These extreme values are defined on the **"AISP"** and **"A2SP"** screens.

Differential alarms are used to signalize deviations between temperature and set point control (SP). Values defined by user on the **"AISP"** and **"A2SP"** screens represent the values of these deviations.

Initial blocking prevents alarm activation when the controller is turned on until the temperature reaches the SP value for the first time.

The error alarm in the sensor allows to signalize errors in the sensor.

The Level End Function (**EndL**) determines that the alarm be activated the end of the cycle.

With Event Alarm, an alarm is activated during execution of a certain program segment.

Table 3 illustrates the operation of each alarm function, using alarm 1 as an example, and presents its identification code on the **"AIFu"** e **"A2Fu"** screens.

Using the Alarm 1 as example.

PROMPT	TYPE	ACTION
oFF	Disabled	Output is not used as alarm.
Lo	Minimum value (Low)	
Hi	Maximum value (High)	
dIF	Differential (diFerential)	  Positive SPAn Negative SPAn
dIFL	Minimum Differential (diFerential Low)	  SPAn positive SPAn negative
dIFH	Maximum Differential (diFerential High)	  Positive SPAn Negative SPAn
iErr	Sensor Break (input Error)	Activated when the input signal of PV is interrupted, out of the range limits or Pt100 in short-circuit.
EndL	End of Level	Activate at the end of the cycle time.
rS	Event (ramp and Soak)	Can be activated at a specific segment of program.

Table 4 – Alarm functions

Where SPAn refers to Setpoints of Alarm **SPR1** and **SPR2**.

PROBLEMS WITH THE CONTROLLER

Connection errors and inadequate programming are the most common errors found during the controller operation. A final revision may avoid loss of time and damages. The controller displays some messages to help the user identify problems.

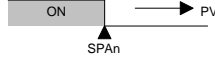
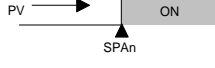
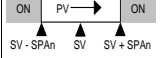
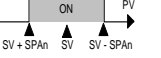
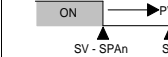
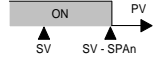
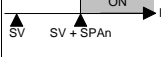
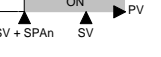
: Sensor measuring temperature below the specified minimum.

: Sensor measuring temperature above the specified maximum.

: Controller failure or sensor error, examples: Thermocouple open, Pt100 open in short circuit or poorly connected.

If the **"Error"** message persists after analysis of the installation, contact manufacturer informing equipment's Serial Number.

FINDING THE CONTROLLER'S VERSION AND SERIAL NUMBER

When the controller is turned on, it shows on its displays for three seconds its **version** (review). To see the **serial number** turn the controller on holding the  key.

This information is necessary for eventual contact with the controller's manufacturer.

SPECIFICATIONS

DIMENSIONS:..... 48 x 48 x 110 mm (1/16 DIN)
 Approximate Weight: 150 g

CUTOUT IN THE PANEL:..... 45.5 x 45.5 mm (+0.5 -0.0 mm)

POWER SUPPLY:..... 100 to 240 Vac/dc ($\pm 10\%$), 50/60 Hz
 Optional 24 V:..... 12 to 24 Vdc / 24 Vac (-10% / 20%)
 Maximum consumption:..... 6 VA

ENVIRONMENTAL CONDITIONS:

Operation Temperature:..... 5 to 50 °C
 Relative Humidity:..... 80 % max. up 30 °C
 For temperatures above 30 °C, reduce 3 % for each °C

Internal Use; Category of installation II, Degree of pollution 2;
 altitude < 2000 m.

INPUT Thermocouples, Pt100 (according to **Table 1**)

Internal Resolution:..... 32767 levels (15 bits)

Resolution of Display:..... 12000 levels (from -1999 up to 9999)

Rate of input reading:..... up to 55 per second

Precision:... Thermocouples **J, K, T, E:** 0.25 % of the *span* ± 1 °C

..... Thermocouples **N, R, S, B:** 0.25 % of the *span* ± 3 °C

..... Pt100: 0.2 % of the *span*

Input Impedance:..... Pt100 and thermocouples: >10 M Ω

Measurement of Pt100: Three wires type, ($\alpha=0.00385$)
 with compensation for cable length, excitation current of 0.170 mA.

All input and output types are factory-calibrated. Thermocouples
 according to standard NBR 12771 / 99, RTD's NBR 13773 / 97;

OUTPUTS

OUTA / OUTC..... Relay SPST-NA: 1.5 A / 240 Vac,
 General use, resistive load; 100 k cycles

OUTB..... Voltage pulse for SSR, 12 V max. / 20 mA

OUTD (RPR / RRR)..... Relay SPDT: 3 A / 250 Vac, general use

OUTD (RAR)..... 0-20 mA or 4-20 mA
 550 Ω max. 31000 levels, Isolated

ELECTROMAGNETIC COMPATIBILITY:

..... EN 61326-1:1997 and EN 61326-1/A1:1998

SAFETY: EN61010-1:1993 and EN61010-1/A2:1995

USB INTERFACE: 2.0, CDC class (virtual communications port),
 MODBUS RTU protocol.

FRONT PANEL: IP65, polycarbonate UL94 V-2;

STARTS UP OPERATION: after 3 seconds connected to the power
 supply.

CERTIFICATIONS: CE / UL (FILE: E300526)

MODEL IDENTIFICATION

The sticker on the controller presents the identification of the model, as
 described below.

N480 D - A - B

Where **A** =

RP: OUTA: Relay; OUTB: Pulse

RPR: OUTA: Relay; OUTB: Pulse; OUTD: Relay

RAR: OUTA: Relay; OUTB: Pulse; OUTC: Relay; OUTD: mA

RRR: OUTA: Relay; OUTB: Pulse; OUTC: Relay; OUTD: Relay

Where **B**=..... **24V** for power supply 12 to 24 Vdc / 24 Vac

..... **blank:** power supply 100-240 Vac/dc

SAFETY INFORMATION

Any control system design should take into account that any part of the
 system has the potential to fail. This product is not a protection or safety
 device and its alarms are not intended to protect against product failures.
 Independent safety devices should be always provided if personnel or
 property are at risk.

Product performance and specifications may be affected by its
 environment and installation. It's user's responsibility to assure proper
 grounding, shielding, cable routing and electrical noise filtering, in
 accordance with local regulations, EMC standards and good installation
 practices.

SUPPORT AND MAINTENANCE

This product contains no serviceable parts inside. Contact our local
 distributor in case you need authorized service. For troubleshooting, visit
 our FAQ at m www.novusautomation.com.

LIMITED WARRANTY AND LIMITATION OF LIABILITY

NOVUS warrants to the original purchaser that this product is free from
 defects in material and workmanship under normal use and service within
 one (1) year from the date of shipment from factory or from its official
 sales channel to the original purchaser.

NOVUS liability under this warranty shall not in any case exceed the cost
 of correcting defects in the product or of supplying replacement product
 as herein provided and upon the expiration of the warranty period all such
 liability shall terminate.

For complete information on warranty and liability limitations, check
 appropriate section in our website: www.novusautomation.com/warranty.