

# Controller N120

## INSTRUCTIONS MANUAL – V2.0x D

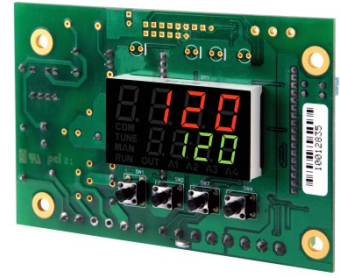

### INTRODUCTION

N120 has all the main features needed for control and alarm functions in different industrial processes. It accepts in a single model the majority of the sensors and signals used in the industry and provides the main output types required for dual action control (Heat and Cool) and alarm monitoring.

The configuration can be performed directly on the controller or through the USB interface. The **NConfig** software (free) is the configuration management tool. Connected to the USB of a Windows computer, the controller is recognized as a serial communications port (COM) running with a Modbus RTU protocol.

Through the USB interface, even if disconnected from the power supply, the configuration performed in a piece of equipment can be saved in a file and repeated in other pieces of equipment that require the same configuration.

The N120 in addition to being a controller is an electronic datalogger. The logger function operates independently of the controller. The parameter setting of the datalogger is made using LogChart-II software.

It is important that the users read carefully this manual before using the controller. Verify if the release of this manual matches the instrument version (the firmware version is shown when the controller is energized).

### MAIN CHARACTERISTICS

- Capable of storing 32700 registers (datalogger);
- Universal multi-sensor input without hardware change;
- Protection for open sensor in any condition;
- Relay and logic pulse control outputs available in the standard model;
- Self-tuning of PID parameters;
- Automatic / Manual function with “bumpless” transfer;
- Up to 4 alarm outputs, with functions of minimum, maximum, differential (deviation), open sensor and event;
- Timer functions that can be associated to the alarms;
- Digital input with 4 functions;
- Programmable *soft-start*;
- 20 setpoint profile programs with 9 segments each, with the ability to be linked together for a total of 180 segments;
- Password for parameters protection;
- Função LBD (*loop break detector*);
- Universal power supply: 100-240 Vac, ±10 %.

### OPERATION

The controller front panel is shown in **Fig. 1**.

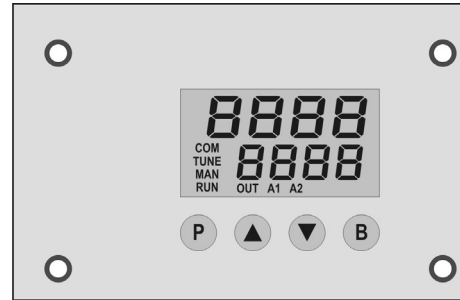

**Fig. 1** – Front panel elements

**Display:** Shows the value and status of the controller parameters.

**COM indicator:** Flashes to indicate communication activity in the RS485 interface.

**TUNE indicator:** Stays ON while the controller is in tuning process.

**MAN indicator:** Signals that the controller is in the manual control mode.

**RUN indicator:** Indicates that the controller is active, with the control output and alarms enabled.

**OUT indicator:** For relay or pulse control output; it reflects the actual state of the output. If an analog output is assigned for control, the OUT indicator lights continuously.

**A1, A2, A3 and A4 indicators:** signalize the occurrence of alarm situation.

**[P] P Key (Program key):** used to walk through the menu parameters.

**[B] Back Key:** used to retrocede parameters.

**[▲] Increment key and [▼] - Decrement key:** allow altering the values of the parameters.

When the controller is turned on, its firmware version is delayed for 3 seconds, after which the controller starts normal operation. The values of PV and SP are displayed and the outputs are enabled.

In order to operate appropriately, the controller needs a configuration that is the definition of each one of the several parameters presented by the controller. The user must be aware of the importance of each parameter and for each one determine a valid condition or a valid value.

**Important:**  
Always the first parameter to set is the input type.

The parameters are grouped in levels according to their functionality and operation easiness. The 7 levels of parameters are:

LEVEL	ACCESS
1 - Operation	Free access
2 - Tuning	Reserved access
3- R&S Programs	
4- Alarms	
5- Scale	
6- Outputs	
7- Calibration	

**Table 1** – Cycles of Parameters

The parameters in the operation level have easy access through the key **P**. The access deeper levels use the combination of keys:

### P and B pressed simultaneously

Press **P** to advance or **B** to retrocede parameters within a level. At the end of each level, the controller returns to the operation level. Keep pressing the **P** key to move fast forward in the level.

Alternatively, the controller returns to the operation level after pressing the **B** key for 3 seconds.

All configuration parameters are stored in protected memory. The values are saved when the Keys **P** or **B** are pressed after changing a parameter value. The value of SP is saved upon pressing the **P** key or every 25 seconds.

## CONFIGURATION / FEATURES

### INPUT TYPE SELECTION

Select the input type (in parameter "TYPE") from Table 2 below.

TYPE	CODE	RANGE OF MEASUREMENT
J	<b>tc J</b>	Range: -110 to 950 °C (-166 to 1742 °F)
K	<b>tc P</b>	Range: -150 to 1370 °C (-238 to 2498 °F)
T	<b>tc t</b>	Range: -160 to 400 °C (-256 to 752 °F)
N	<b>tc n</b>	Range: -270 to 1300 °C (-454 to 2372 °F)
R	<b>tc r</b>	Range: -50 to 1760 °C (-58 to 3200 °F)
S	<b>tc S</b>	Range: -50 to 1760 °C (-58 to 3200 °F)
B	<b>tc b</b>	Range: 400 to 1800 °C (752 to 3272 °F)
E	<b>tc E</b>	Range: -90 to 730 °C (-130 to 1346 °F)
Pt100	<b>Pt</b>	Range: -200 to 850 °C (-328 to 1562 °F)
0-20 mA	<b>LQ20</b>	Linear Signals Programmable indication from -1999 to 9999.
4-20 mA	<b>L420</b>	
0-50 mV	<b>LQ50</b>	
0-5 Vdc	<b>LQ5</b>	
0-10 Vdc	<b>LQ10</b>	

Table 2 - Input types

### OUTPUTS

Up to 3 outputs can be configured for control (1 or 2) or alarm. The available outputs are identified on the rear panel as **out1**, **out2** e **out3**. Electrical characteristics of each output are:

**OUT1:** Voltage Pulse, 5 Vdc / 25 mA;

**OUT2** output to Relay SPST-NA;

**OUT3** output to Relay SPST-NA;

The option to be used on each output is user-defined according to the options shown in Table 3 e Table 4.

Outputs Functions	Code
Inoperative	<b>oFF</b>
Alarm 1 output	<b>R1</b>
Alarm 2 output	<b>R2</b>
Alarm 3 output	<b>R3</b>
Alarm 4 output	<b>R4</b>
Loop break detection output	<b>Lbd</b>
Control 1 output	<b>ctr1</b>
Control 2 output	<b>ctr2</b>

Table 3 – Outputs Functions

- In the channel configuration are shown on the display, only the valid options for each channel. These functions are described below:

- oFF** - No function.

The I/O channel programmed with code 0 will not be used by the controller.

- Note: Even though functionless, this channel can be activated by commands via serial communication (MODBUS command 5).

- R1, R2, R3, R4** - Alarm output.

Available for all I/O channels. The selected channel can be used as output to Alarms 1 to 4.

- Lbd** – Loop Break Detector function.

Assigns the output of the Loop Break Detector alarm to an I/O channel. Available to all I/O channels.

- ctr1** - Control output 1.

- ctr2** - Control output 2.

### DIGITAL INPUT

Defines the operation adopted by the available digital input terminals 7 and 8 of the controller. The D.in1 parameter defines the desired function. There are 5 options possible.

Digital Input Functions	Code
No function	<b>oFF</b>
Automatic/Man mode change	<b>MAN</b>
Run/Stop mode change	<b>run</b>
Freezes program execution	<b>HPRG</b>
Program 1 selection	<b>Pr1</b>

- Table 4 – Functions for the digital input channels

- These functions are described below:

- MAN** - Digital Input with Auto/Manual function

Closed: Manual control

Opened: Automatic control

- run** - Digital Input with RUN function

Closed: = outputs enabled

Opened: = outputs disabled

- HPRG** - Digital Input with Hold Program function

Closed: = Enables execution of the program

Opened: = Interrupts (freezes) execution of the program

- Note: Even when the execution of the program is interrupted, the control output remains active and controlling the process at the point (Setpoint) of interruption. The program will resume its normal execution starting from this same point when the digital input is closed.

- Pr1** - Digital Input with function to Execute Program 1

Defines the IO channel as Digital Input with the function of commanding the execution of the setpoint profile **program 1**.

Closed: = Selects program 1

Opened: = Uses main Setpoint

Even with ED in OFF the LogChart can start Logging.

### ALARMS FUNCTIONS

The controller has 4 independent alarms. They can be programmed to operate with eight different functions, represented in Table 5.

- oFF** – Alarms turned off.

- IErr** – Sensor break alarm.

It is activated whenever the input sensor is broken or disconnected.

- r5** – Ramp & soak program event alarm

This alarm is activated by the Ramp & Soak program (refer to the programs of ramp and soak section on how to set the event alarm).

- **Lo** – Alarm of Absolute Minimum Value

It is activated when the measured value is **below** the value defined in the alarm Setpoint.

- **HI** – Alarm of Absolute Maximum Value

It is activated when the measured value is **above** the value defined in the alarm Setpoint.

- **dIF** – Alarm of Differential Value

In this function, the parameters “**SPA1**”, “**SPA2**”, “**SPA3**” and “**SPA4**” represent the PV deviation as compared to the main SP.

Using the Alarm 1 as example: for Positive SPA1 values, the differential alarm will be triggered when the PV value is **out** of the range defined in:

$$(SP - SPA1) \text{ to } (SP + SPA1)$$

For a negative SPA1 value, the differential alarm will be triggered when the PV value is **within** the range defined above

- **dIFL** – Alarm of Minimum Differential Value

It is activated when the PV value is below the value defined in:

$$(SP - SPA1)$$

Using the Alarm 1 as example.

- **dIFH** – Alarm of Maximum Differential Value

It is activated when the PV value is above the value defined in:

$$(SP + SPA1)$$

Using the Alarm 1 as example.

The alarm functions are described in **Table 5**.

SCREEN	TYPE	ACTUATION
<b>oFF</b>	Inoperative	Output is not used as alarm.
<b>IErr</b>	Open sensor (input Error)	Activated when the input signal of PV is interrupted, out of the range limits or Pt100 in short-circuit.
<b>rS</b>	Event (ramp and Soak)	Activated in a specific segment of program.
<b>Lo</b>	Minimum value (Low)	
<b>HI</b>	Maximum value (High)	
<b>dIF</b>	Differential (diFferential)	
<b>dIFL</b>	Minimum Differential (diFferential Low)	
<b>dIFH</b>	Maximum differential (diFferential High)	

**Table 5** – Alarm Functions

Where SPAn refers to Setpoints of Alarm “**SPA1**”, “**SPA2**”, “**SPA3**” and “**SPA4**”.

### ALARM TIMER MODES

The controller alarms can be configured to perform 3 timer modes:

- One pulse with defined duration;
- Delayed activation;
- Repetitive pulses;

The illustrations in **Table 6** show the behavior of the alarm output for various combinations of times t1 and t2. The timer functions can be configured in parameters **A1t1**, **A1t2**, **A2t1**, **A2t2**, **A3t1**, **A3t2**, **A4t1** and **A4t2**.

OPERATION	T 1	T 2	ACTION
Normal Operation	0	0	
Activation for a defined time	1 to 6500 s	0	
Activation with delay	0	1 to 6500 s	
Intermittent Activation	1 to 6500 s	1 to 6500 s	

**Table 6** – Temporization Functions for the Alarms

The signs associated to the alarms will light when the alarm condition is recognized, not following the actual state of the output, which may be temporarily OFF because of the temporization.

### INITIAL BLOCKING OF ALARM

The initial blocking option inhibits the alarm from being recognized if an alarm condition is present when the controller is first energized (or after a transition from run YES → NO). The alarm will be enabled only after the occurrence of a non alarm condition followed by a new occurrence for the alarm.

The initial blocking is useful, for instance, when one of the alarms is configured as a minimum value alarm, causing the activation of the alarm soon upon the process start-up, an occurrence that may be undesirable.

The initial blocking is disabled for the sensor break alarm function.

### SOFT-START

The soft-start feature avoids abrupt variations in the power delivered to the load regardless of the system power demand. .

This is accomplished by defining a limiting ramp for the control output. The output is allowed to reach maximum value (100 %) only after the time programmed in the soft-start parameter has elapsed. The Soft-start function is generally used in processes that require slow start-up, where the instantaneous application of 100% of the available power to the load may cause damages to parts of the system.

In order to disable this function, the soft-start parameter must be configured with 0 (zero). Soft Start is available only for Control Output 1.

### CONTROL MODE

The controller can operate in two different manners: Automatic mode or Manual mode. In automatic mode the controller defines the amount of power to be applied on the process, based on defined parameters (SP, PID, etc.).

In the manual mode the user himself defines this amount of power. The parameter “**Ctrl**” defines the control mode to be adopted.

### PID AUTOMATIC MODE

For the Automatic mode, there are two different strategies of control: PID control and ON/OFF control 1.

PID control has its action based on a control algorithm that takes into account the deviation of PV with respect to SP, the rate of change of PV and the steady state error.

On the other hand, the ON/OFF control (obtained when Pb=0) operates with 0% or 100% of power, when PV deviates from SP.

The determination of the PID parameters (Pb, Ir and Dt) is described in the item DETERMINATION OF PID PARAMETERS of this manual.

### CONTROL 2

The N120 offers a second independent control output (Control Output 2). This output, with only proportional action is generally used in cooling processes when using the heating action the control output 1.

When the application requires both heating and cooling at the same time, you must set the parameters **Rct=rE** and adjust the overlap (**oLAR**) to determine the type of operation.

There are three situations:

**oLAR** > 0; when there are overlapping between heating and cooling actions.

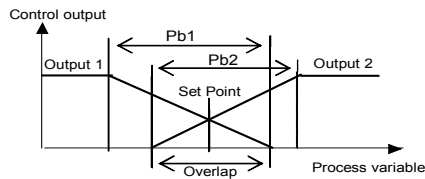

**oLAR** < 0; for setting a dead-band.

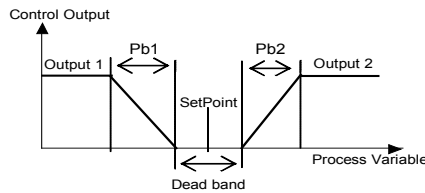

**oLAR** = 0; no superposition or dead-band for the outputs.

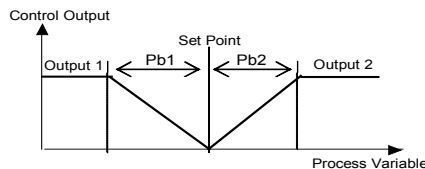

Output 2 has independent proportional band and PWM period, as well as maximum and minimum limits for the output.

If **Pb2**=0, the control #2 becomes ON-OFF.

Both outputs can be on at the same time even with negative **oLAR** if Control Output 1 is using PID control.

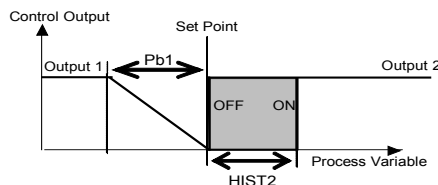

### LBD - LOOP BREAK DETECTION ALARM

The parameter defines a time interval, in minutes, within which the PV is expect to react to a control output signal. If the PV does not react properly within the time interval configured in **Lbd.t**, the controller interprets this as a control loop break and signals this occurrence in the display.

A LBD event may be sent to any I/O channel. Simply configure the **Ldb** function to the desired I/O channel: the selected output will be activated when a **Ldb** condition is detected. When the **Lbd.t** parameter is programmed with 0 (zero), the **Ldb** function is disabled.

The **Ldb** is useful in system supervision and troubleshooting, allowing early detection of problems in the actuator, power source or load.

### SAFE OUTPUT VALUE WITH SENSOR FAILURE

(Output 1 only)

This function defines an output value (user defined) to be assigned to the control output in the event of a sensor failure.

When the input sensor is identified as broken, the controller switches the control mode to MANUAL while forcing MV to assume the user configured value in the **IEou** parameter.

This function requires that one of the alarms be configured as **IErr** and the **IEou** parameter (control output percentage) programmed with a value other than 0 (zero).

Once this function is triggered, the controller remains in SAFE mode (MANUAL control output) even after the sensor failure appears to be fixed. The operator intervention is required for switching back to AUTO mode.

### USB INTERFACE

The USB interface is used for CONFIGURING or MONITORING the controller. The **NConfig** software must be used for the configuration. It makes it possible to create, view, save and open configurations from the equipment or files in your computer. The tool for saving and opening configurations in files makes it possible to transfer configurations between pieces of equipment and to make backup copies. For specific models, the **NConfig** software also makes it possible to update the firmware (internal software) of the controller through the USB.

For MONITORING purposes you can use any supervisory software (SCADA) or laboratory software that supports the MODBUS RTU communication on a serial communications port. When connected to the USB of a computer, the controller is recognized as a conventional serial port (COM x). Use the **NConfig** software or consult the DEVICE MANAGER in the Windows CONTROL PANEL to identify the COM port that was assigned to the controller. Consult the mapping of the MODBUS memory in the controller's communications manual and the documentation of your supervisory software to conduct the MONITORING process.

Follow the procedure below to use the USB communication of the equipment:

- Download the **NConfig** software from our website and install it on your computer. The USB drivers necessary for operating the communication will be installed together with the software.
- Connect the USB cable between the equipment and the computer. The controller does not have to be connected to a power supply. The USB will provide enough power to operate the communication (other equipment functions cannot operate).
- Open the **NConfig** software, configure the communication and start recognition of the device.

 	<p>The USB interface IS NOT SEPARATE from the signal input (PV) or the controller's/indicator's digital inputs and outputs. It is intended for temporary use during CONFIGURATION and MONITORING periods. For the safety of people and equipment, it must only be used when the piece of equipment is completely disconnected from the input/output signals. Using the USB in any other type of connection is possible but requires a careful analysis by the person responsible for installing it. When MONITORING for long periods of time and with connected inputs and outputs, we recommend using the RS485 interface, which is available or optional in most of our products.</p>
------	---

### INSTALATION

The controller was designed to be fixed by screws, behind a face of metal panels of equipment or machinery. Display and keyboard should fit in appropriate cut of this panel. The following figures show the dimensions and distances required for attachment.

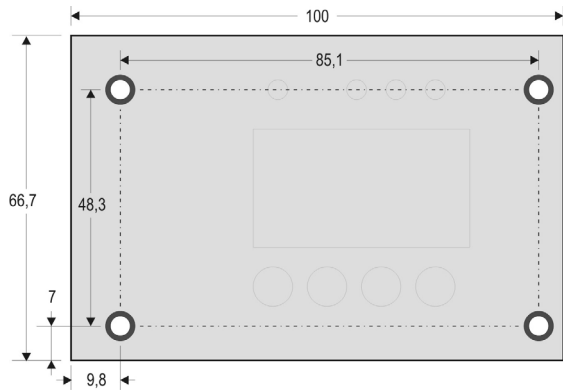

Fig. 2a – Screws mounting holes. Frontal view

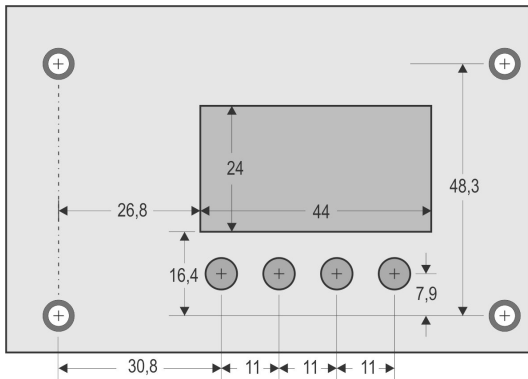

Fig. 2b – Keypad, display and leds distances. Front view.

### RECOMMENDATIONS FOR THE INSTALLATION

- The input signals conductors shall be positioned throughout the factory separate from the output and the power supply conductors, in grounded conduits if possible.
- All electronic instruments must be powered by a clean mains supply, proper for instrumentation.
- It is strongly recommended to apply RC'S FILTERS (noise suppressor) to contactor coils, solenoids, etc.
- In any application it is essential to consider what can happen when any part of the system fails. The controller features by themselves can not assure total protection.

### ELECTRICAL WIRING

Fig. 3a and Fig. 3b: shows the electrical connections.

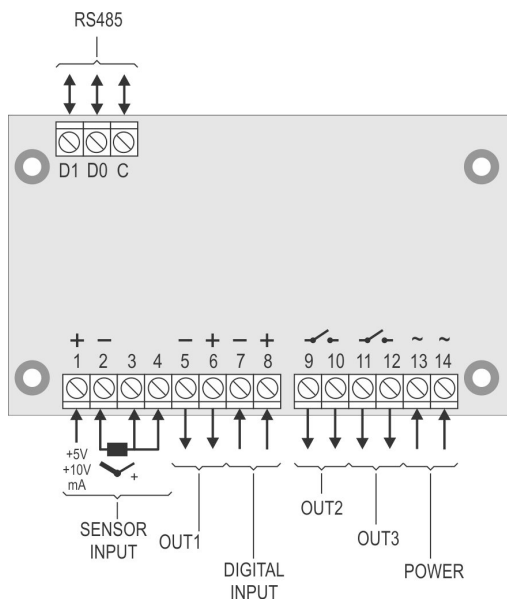

Fig. 3a – Input, outputs, mains supply and RS485 interface.

### Sensor Input Connections

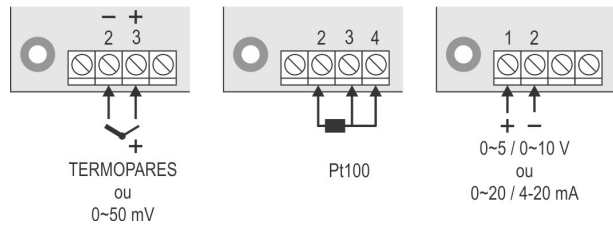

Fig. 3b – Input wiring, outputs, power supply and serial communication connections

The input types 0~20 and 4~20 mA are not available in the controller's standard model, although shown as an option at the **TYPE** parameter. These inputs are only available in some custom models.

The models with 0~20 and 4~20 mA inputs do not accept 0~5 V and 0~10 V inputs types.

## DESCRIPTION OF THE PARAMETERS

### OPERATION LEVEL

To access the operation level parameters, press the **P** key until the desired parameter is displays.

Indicação de PV (Visor Vermelho)	<b>PV and SP indication</b> - The upper display shows the current value of PV. The lower display shows the control SP value.
Indicação de SP (Visor Verde)	
<b>Ctrl</b>	<b>Control Mode</b> - <b>Auto</b> - Means automatic control mode. <b>Man</b> - Means manual control mode. (bumpless transfer between automatic and manual control modes).
PV Indication (Red Screen)	<b>Manipulated Variable 1 Value (MV)</b> - The upper display shows PV value and the lower display shows the percentage of MV1 applied to the control output. When in manual control, the MV1 value can be changed. When in auto mode the MV value can only be viewed.  To distinguish the MV1 display from the SP display, the MV1 is shown flashing intermittently.
MV Indication (Green Screen)	
PV Indication (Red Screen)	<b>Manipulated Variable 2 Value (MV)</b> - The upper display shows PV value and the lower display shows the percentage of MV2 applied to the control output. When in manual control, the MV2 value can be changed. When in auto mode the MV value can only be viewed.  To distinguish the MV2 display from the SP display, the MV2 is shown flashing intermittently.
MV Indication (Green Screen)	
<b>E Pr</b>	<b>Enable Program</b> . Selects the ramp and soak profile program to be executed. <b>0</b> - does not execute program <b>1 to 20</b> number of the program to be executed With enabled outputs ( <b>run= YES</b> ), the program starts right after the program is selected.
<b>P.SEG</b>	Screen for indication only. When a ramp and soak program is active, this parameter shows the number of the segment under execution, from 1 to 9.
<b>L.SEG</b>	Screen for indication only. When a ramp and soak program is in execution, it shows the remaining time to the end of the current segment, in units of time configured in the <b>Pr.tb</b> parameter.
<b>run</b>	Enables control outputs and alarms. <b>YES</b> - Outputs enables. <b>no</b> - Outputs not enabled.

## TUNING LEVEL

<b>Run</b>	Auto-tune. Defines the control strategy to be taken - <b>OFF</b> – Turned off. (no PID tuning) <b>FAST</b> – automatic tuning. <b>FULL</b> – More accurate automatic tuning. <b>SELF</b> – Precise + auto - adaptative tuning <b>rSLF</b> – Forces <u>one</u> new precise automatic precise + auto - adaptative tuning. <b>tGht</b> – Forces <u>one</u> new precise automatic + auto - adaptative tuning when Run = YES or controller is turned on.
<b>Pb1</b>	Proportional Band. Value of the term <b>P</b> of the control 1 mode PID, in percentage of the maximum span of the input type. Select zero for ON/OFF control.
<b>Ir</b>	Integral Rate. Value of the term <b>I</b> of the PID algorithm, in repetitions per minute (Reset).  Displayed only if proportional band ≠ 0.
<b>dt</b>	Derivative Time. Value of the term <b>D</b> of the control mode PID, in seconds. Adjustable between 0 and 300.0 seconds.  Displayed only if proportional band ≠ 0.
<b>Ct1</b>	Cycle Time. Pulse Width Modulation (PWM) period in seconds to Control 1. Displayed only if proportional band ≠ 0.
<b>Hyt1</b>	Control 1 Hysteresis (in engineering. units): This parameter is only shown for ON / OFF control (Pb1=0). Adjustable between 0 and the measurement input type span.
<b>Act</b>	Control Action. For Auto Mode only. <b>rE</b> Control with reverse Action. Appropriate for <b>heating</b> . Turns control output on when PV is below SP. <b>dIr</b> Control with direct Action. Appropriate for <b>cooling</b> . Turns control output on when PV is above SP.  For the control output 2, the control action is always opposite to the one defined for control output 1.
<b>bIAS</b>	Function Bias. Offset for MV (manual reset). Range: -100 % to +100 %.  Allows adding a percentage value between -100 % and +100 % to the MV control output The value 0 (zero) disables the function.
<b>oLL</b>	Output Low Limit. Lower limit for the control 1 output - Minimum percentage value assumed by the control output when in automatic mode and in PID.  Typically configured with 0 %. Default value: 0 %
<b>oHL</b>	Output High Limit. Upper limit for the control 1 output - Maximum percentage for the control output when in automatic mode and in PID.  Typically configured with 100 %. Default value: 100 %
<b>Pb2</b>	Proportional Band 2. Value of the <b>P</b> term for control output 2, in percentage of the maximum span of the input type.  <b>Select zero, and the hysteresis control is set in the oLAP screen.</b>
<b>Hyt2</b>	Control 2 Hysteresis. This parameter is only shown for ON / OFF control (Pb2=0). Adjustable between 0 and the measurement input type span.
<b>oLAP</b>	Overlap. Defines the overlap between the heat and cool outputs. The overlap is given in engineering units of the input type used.  When the overlap value is negative, it represents the value of the dead-band instead.
<b>Ct2</b>	Cycle Time. PWM period in seconds. Can only be viewed if proportional band is other than zero.

<b>o2LL</b>	Output Low Limit: minimum. Percentage value for MV (Manipulated Variable) when in automatic control and PID. Default value: 0.0 %
<b>o2HL</b>	Output High Limit: Maximum. Percentage value for MV when in automatic control and PID. Default value: 100.0 %
<b>SFS</b>	SoftStart Function. Time in seconds during which the controller limits the MV value progressively from 0 to 100 %. It is enabled at power up or when the control output is activated. If in doubt set zero (zero value disables the Soft start function).
<b>Lbdt</b>	Loop break detection time. Time interval for the LBD function. Defines the maximum interval of time for the PV to react to a control command. In minutes.
<b>SPA1</b> <b>SPA2</b> <b>SPA3</b> <b>SPA4</b>	Alarm Setpoint. Tripping points for alarms 1 and 2. Value that defines the point of activation for the programmed alarms with the functions "Lo" or "Hi".  For the alarms configured with <b>Differential</b> type functions, this parameter defines deviation (band).  Not used for the other alarm functions.

## R&S PROGRAMS LEVEL

<b>Pr.tb</b>	Program time base. Defines the time base that will be used by all Ramp & Soak programs.  <b>SEC</b> - Time basis in seconds; <b>min</b> - Time basis in minutes;
<b>Pr n</b>	Program number. Selects the ramp and soak profile program to be edited/viewed. The sequence of parameters that follows refer to this selected program. Total of 20 programs possible.
<b>Ptol</b>	Program Tolerance. Maximum admitted deviation of PV with respect to SP. If exceeded, the program execution is suspended (the internal timer freezes) until the deviation be returns back within the defined tolerance.  The value 0 (zero) disables the function (the program progresses regardless of the difference between PV and SP).
<b>PSP0</b> <b>PSP9</b>	Program SP's, 0 to 9: Group of 10 values of SP that define the Ramp and Soak profile segments.
<b>Pt1</b> <b>Pt9</b>	Segments durations, 1 to 9: Defines the time of duration, in second or minutes, of the segments of the program being edited.
<b>PE1</b> <b>PE9</b>	Program event. Alarms of Event, 1 to 9: Parameters that define which alarms are to be activated during the execution of a certain program segment. The alarms chosen must have its function configured as "r5." (See Table 3)
<b>PSP1</b> <b>PSP9</b>	Program SP. Ramp and Soak Set Points: (0 to 9): Set of 10 SV values which define the ramp and soak profile segments.
<b>LP</b>	Link Programs. Number of the next profile program to be linked following the current program. Profiles can be linked together to produce larger programs of up to 180 segments.  0 – do not link to any other program.

## ALARMS LEVEL

<b>FJA1</b> <b>FJA2</b> <b>FJA3</b> <b>FJA4</b>	Functions of Alarms. Defines the functions for the alarms among the options of the Table 3.  <b>OFF, iErr, r5, Lo, Hi, dIFL, dIFH, dIF</b>
<b>BLA1</b> <b>BLA2</b> <b>BLA3</b> <b>BLA4</b>	Blocking Alarm. This function blocks the alarm at power-up when the units is first energized.  <b>YES</b> - Enables. <b>no</b> - Inhibits this blocking function.

<b>HYA1</b> <b>HYA2</b> <b>HYA3</b> <b>HYA4</b>	Hysteresis of Alarm. Defines the difference between the value of PV at which the alarm is triggered and the value at which it is turned off (in engineering units).
<b>A1t1</b> <b>A2t1</b> <b>A3t1</b> <b>A4t1</b>	Alarm Time t1. Defines the temporization time t1, in seconds, for the alarms. Defines the temporization time t1, in seconds, for the alarms time functions.  The value 0 (zero) disables the function.
<b>A1t2</b> <b>A2t2</b> <b>A3t2</b> <b>A4t2</b>	Alarm Time t2. Defines the temporization time t2, in seconds, for the alarms. Defines the temporization time t2, in seconds, for the alarms time functions.  The value 0 (zero) disables the function.
<b>FLSh</b>	Flash. Allows visual signalization of an alarm occurrence by flashing the indication of PV in the operation level. The user chooses which alarms are to be associated with this feature.



#### SCALE LEVEL

<b>TYPE</b>	Input Type. Selects the input signal type to be connected to the process variable input. Refer to <b>Table 2</b> for the available options.  <b>Necessarily the first parameter to be configured.</b>
<b>FLtr</b>	Digital Input Filter. Used to improve the stability of the measured signal (PV). Adjustable between 0 and 20. In 0 (zero) it means filter turned off and 20 means maximum filter. The higher the filter value, the slower is the response of the measured value.
<b>dPp0</b>	Decimal Point. Selects the decimal point position to be viewed in both PV and SP.
<b>unit</b>	Unit. Temperature indication in °C or °F. Not shown for linear inputs. Parameter presented when used temperature sensors.
<b>OFFS</b>	Sensor Offset. Offset value to be added to the PV reading to compensate sensor error. Default value: zero.
<b>SPLL</b>	Setpoint Low Limit. Defines the SP lower limit of.  For the linear analog input types available (0-20 mA, 4-20 mA, 0-50 mV and 0-5 V), defines the minimum PV indication range, besides limiting the SP adjustment.  Defines lower limit for range retransmission PV and SP.
<b>SPHL</b>	Setpoint High Limit. Defines the upper limit for adjustment of SP.  For the linear analog input types available (0-20 mA, 4-20 mA, 0-50 mV and 0-5 V), defines the maximum PV indication range, besides limiting the SP adjustment.  Defines upper limit for range retransmission PV and SP.
<b>IEou</b>	Percentage output value that will be transfer to MV when the SAFE output function is enabled. If <b>IEou</b> = 0, the SAFE output function is disabled and the outputs are turned off in the occurrence of a sensor fail.
<b>bAud</b>	Digital communication <i>Baud Rate</i> selection, in kbps: 1.2, 2.4, 4.8, 9.6, 19.2, 38.4, 57.6 and 115.2
<b>Prty</b>	Parity of the serial communication.  <b>nanE</b> - Without parity <b>EUE<sub>n</sub></b> - Even parity <b>Odd</b> - Odd parity
<b>Addr</b>	Slave Address Selection. Identifies the controller in the network. The possible address numbers are from 1 to 247.

#### I/O CYCLE (INPUTS AND OUTPUTS)

<b>out1</b>	I/O 1 Function: Selects the I/O function to be used at I/O 1 (relay 1). Refer to <b>Table 3</b> for functions.
<b>out2</b>	I/O 2 Function: Selects the I/O function to be used at I/O 2 (relay 2). Refer to <b>Table 3</b> for functions.
<b>out3</b>	I/O 3 Function: Selects the I/O function to be used at I/O 3 (relay 3). Refer to <b>Table 3</b> for functions.
<b>d.in1</b>	Digital Input Function (DIGITAL INPUT). As <b>Table 4</b> .

#### CALIBRATION CYCLE

All of the input and output types are calibrated in the factory. If a recalibration is required, this should be carried out by a experienced personnel. If this cycle is accidentally accessed, pass through all the parameters without pressing the  or  keys.

<b>PASS</b>	Input of the Access Password.  This parameter is presented before the protected cycles. See item <b>Protection of Configuration</b> .
<b>CALib</b>	Allows instrument calibration. <b>YES</b> - Perform calibration <b>no</b> - Do not perform calibration
<b>inLC</b>	Input Low Calibration. See section MAINTENANCE / Input Calibration.  Enter the value corresponding to the low scale signal applied to the analog input.
<b>inHC</b>	Input High Calibration. See section MAINTENANCE / Input Calibration.  Enter the value corresponding to the full scale signal applied to the analog input.
<b>rStr</b>	Restores the factory calibration for all input, analog output and remote SP, disregarding modifications carried out by the user.
<b>CJ</b>	Adjusts the of cold junction temperature value.
<b>PASC</b>	Allows defining a new access password, always different from zero.
<b>Prot</b>	Sets up the Level of Protection. See <b>Table 6</b> .
<b>FrEQ</b>	Mains frequency. This parameter is important for proper noise filtering.

#### PROTECTION OF CONFIGURATION

The controller provides means for protecting the parameters configurations, not allowing modifications to the parameters values, avoiding tampering or improper manipulation.

The parameter **Protection (Prot)**, in the Calibration level, determines the protection strategy, limiting the access to particular levels, as shown by the table below.

Protection level	Protected cycles
1	Only the Calibration level is protected.
2	Outputs and Calibration levels are protected.
3	Scale, Outputs and Calibration levels are protected.
4	Alarm, Scale, Outputs and Calibration levels are protected.
5	R&S Program, Alarm, Scale, Outputs and Calibration levels are protected.
6	Tuning, R&S Program, Alarm, Scale, Outputs and Calibration levels are protected.
7	Operation (except SP), Tuning, R&S Program, Alarm, Scale, Outputs and Calibration levels are protected.
8	Operation, Tuning, R&S Program, Alarm, Scale, Outputs and Calibration levels are protected.

**Table 7** – Levels of Protection for the Configuration

## ACCESS PASSWORD:

The protected levels, when accessed, request the user to provide the **Access Password** for granting permission to change the configuration of the parameters on these cycles.

The prompt **PR55** precedes the parameters on the protected levels. If no password is entered, the parameters of the protected cycles can only be visualized.

The Access Code is defined by the user in the parameter *Password Change (PR5C)*, present in the Calibration level. The factory default for the password code is 1111.

## PROTECTION OF THE ACCESS CODE

The protection system built into the controller blocks for 10 minutes the access to protected parameters after 5 consecutive frustrated attempts of guessing the correct password.

## MASTER PASSWORD

The Master Password is intended for allowing the user to define a new password in the event of it being forgotten. The Master Password doesn't grant access to all parameters, only to the Password Change parameter (**PR5C**). After defining the new password, the protected parameters may be accessed (and modified) using this new password.

The master password is made up by the last three digits of the serial number of the controller **added** to the number 9000.

As an example, for the equipment with serial number 07154321, the master password is 9321.

## PROGRAMS OF RAMP AND SOAK

This feature allows the creation of Ramp and Soak Setpoint Profiles (Programs). Up to **20 different profiles** with **9 segments** each can be programmed. Longer profiles of up to 180 segments can be created by linking 2 or more profiles together.

The figure below displays a profile model:

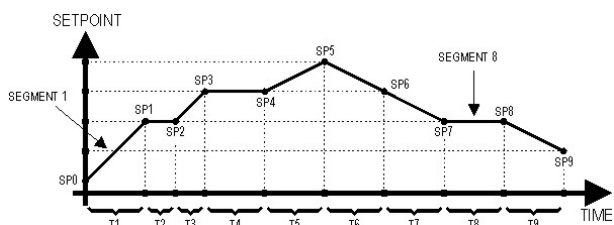

Fig. 4 - Example of a Ramp and Roak

Once a profile is defined and selected for execution (parameter **EP** in the operating level), the controller starts to generate the SP profile automatically in accordance with the elaborated program.

To execute a profile with fewer segments just program 0 (zero) for the time intervals that follow the last segment to be executed.

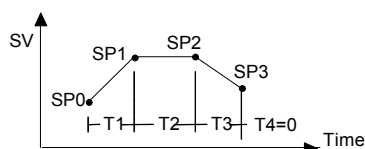

Fig. 5 - Program example with few segments

The program tolerance defines the maximum deviation between PV and SP for the execution of the profile. If this deviation is exceeded, the program will be halted until the deviation falls to within the tolerance band.

Programming 0 (zero) in the "**Ptol**" parameter disables the program tolerance and the profile execution will continue regardless of the PV value (time priority as opposed to SP priority).

## LINK OF PROGRAMS

It is possible to create a more complex program, with up to 180 segments, joining the 20 programs. This way, at the end of a program execution the controller immediately starts to run the next one, as indicated in the "**LP**".

To force the controller to run a given program or many programs continuously, it is only necessary to link a program to itself or the last program to the first.

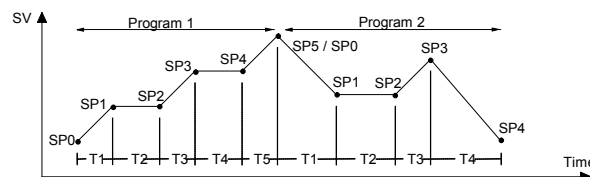

Fig. 6 - Example of interlinked programs

## EVENT ALARM

The Event Alarm function associates the alarms to specific segments of a program. The information of which alarms are to be activated or deactivated is given in parameters "**PE 1**" to "**PE 9**". Press the **▲** and **▼** keys until the desired alarm numbers are displayed.

The Event Alarm requires that the Alarm function be configured as "**r5**".

### Notes:

1. If **Ptol** is different than zero, the controller will wait for the PV to reach the first program set point SP0 in order to start the program execution. Otherwise, it will start promptly.
2. Should any power failure occur, the controller resumes the program execution at the beginning of the segment that was interrupted.

## DETERMINATION OF PID PARAMETERS

The determination (or tuning) of the PID control parameters in the controller can be carried out in an automatic way and auto-adaptive mode. The **automatic tuning** is always initiated under request of the operator, while the **auto-adaptive tuning** is initiated by the controller itself whenever the control performance becomes poor.

Only PID parameters (Control Output 1) can be automatically calculated by N120. Control Output 2 Proportional Band and Overlap must be manually adjusted.

**Automatic tuning:** In the beginning of the **automatic tuning** the controller has the same behavior of an ON/OFF controller, applying minimum and maximum performance to the process. Along the tuning process the controller's performance is refined until its conclusion, already under optimized PID control. It begins immediately after the selection of the options FAST, FULL, RSLF or TGHT, defined by the operator in the parameter ATUN.

**Auto-adaptive tuning:** Is initiated by the controller whenever the control performance is worse than the one found after the previous tuning. In order to activate the performance supervision and **auto-adaptive tuning**, the parameter ATUN must be adjusted for SELF, RSLF or TGHT. The controller's behavior during the **auto-adaptive tuning** will depend on the worsening of the present performance. If the maladjustment is small, the tuning is practically imperceptible for the user. If the maladjustment is big, the **auto-adaptive tuning** is similar to the method of **automatic tuning**, applying minimum and maximum performance to the process in ON/OFF control.



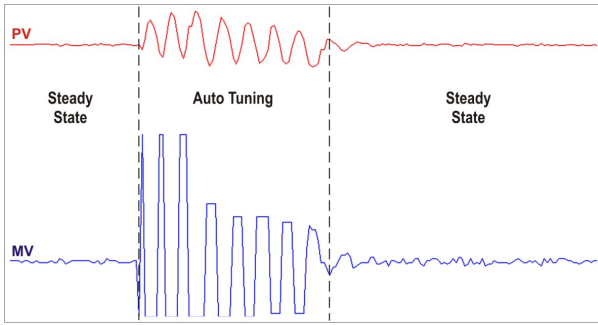

Fig. 7 – Example of auto tuning

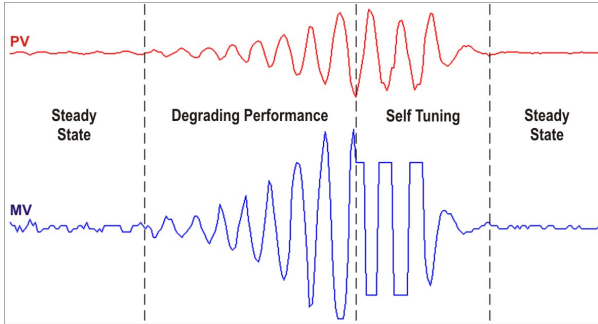

Fig. 8 - Example of auto-adaptive tuning

The operator may select, through the ATUN parameter, the desired tuning type among the following options:

- **OFF:** The controller does not carry through **automatic tuning** or **auto-adaptive tuning**. The PID parameters will **not** be automatically determined **nor** optimized by the controller.
- **FAST:** The controller will accomplish the process of **automatic tuning** one single time, returning to the OFF mode after finishing. The tuning in this mode is completed in less time, but not as precise as in the FULL mode.
- **FULL:** The same as the FAST mode, but the tuning is more precise and slower, resulting in better performance of the P.I.D. control.
- **SELF:** The performance of the process is monitored and the **auto-adaptive tuning** is automatically initiated by the controller whenever the performance becomes poorer.

After the tuning process, the controller enters a learning phase when it collects data relative to the process performance. This phase, which is dependent of the response time of the process, is indicated by a flashing TUNE indicator. Once this learning is completed, the controller is able to decide whether or not a new tuning is required to improve system response.

It is recommended not to turn the controller off neither change the SP value during this phase.

- **rSLF:** Accomplishes the **automatic tuning** and returns into the SELF mode. Typically used to force an immediate **automatic tuning** of a controller that was operating in the SELF mode, returning to this mode at the end.
- **TGHT:** Similar to the SELF mode, but in addition to the **auto-adaptive tuning** it also executes the **automatic tuning** whenever the controller is set in RUN=YES or when the controller is turned on.

Whenever the parameter ATUN is altered by the operator into a value different from OFF, an automatic tuning is immediately initiated by the controller (if the controller is not in RUN=YES, the tuning will begin when it passes into this condition). The accomplishment of this automatic tuning is essential for the correct operation of the auto-adaptive tuning.

The methods of **automatic tuning** and **auto-adaptive tuning** are appropriate for most of the industrial processes. However, there may be processes or even specific situations where the methods are not capable to determine the controller's parameters in a satisfactory way, resulting in undesired oscillations or even taking the process to extreme conditions. The oscillations themselves imposed by the

tuning methods may be intolerable for certain processes. These possible undesirable effects must be considered before beginning the controller's use, and preventive measures must be adopted in order to assure the integrity of the process and users.

The "TUNE" signaling device will stay on during the tuning process.

In the case of PWM or pulse output, the quality of tuning will also depend on the cycle time adjusted previously by the user.

If the tuning does not result in a satisfactory control, refer to **Table 7** for guidelines on how to correct the behavior of the process.

PARAMETER	VERIFIED PROBLEM	SOLUTION
Proportional Band	Slow answer	Decrease
	Great oscillation	Increase
Rate of Integration	Slow answer	Increase
	Great oscillation	Decrease
Derivative Time	Slow answer or instability	Decrease
	Great oscillation	Increase

Table 07 - Guidance for manual adjustment of the PID parameters

## SPECIFICATIONS

**DIMENSIONS:**.....100 x 67 mm

..... Approximate Weight: 80 g

**POWER SUPPLY:**..... 100 to 240 Vac/dc ( $\pm 10\%$ ), 50/60 Hz, 5 VA

### ENVIRONMENTAL CONDITIONS:

Operation Temperature: ..... 5 to 60 °C

Relative Humidity: .....80% max. 30 °C

For temperatures above 30 °C, reduce 3% for each °C

**INPUT**..... T/C, Pt100, voltage and current (according to **Table 2**)

**Internal Resolution:** ..... 32767 levels (15 bits)

**Resolution of Display:** ..... 12000 levels (from - 1999 up to 9999)

**Rate of input reading:** ..... up to 55 per second

**Precision:** .. Thermocouples J, K, T, E: 0.25% of the span  $\pm 1$  °C

..... Thermocouples N, R, S, B: 0.25% of the span  $\pm 3$  °C

..... Pt100: 0.2% of the span

..... 0-50 mV, 0-5 Vdc: 0.2% of the span

**Input Impedance:** 0-50 mV, Pt100 and Thermocouples: >10 M $\Omega$

..... 0-5 V: >1 M $\Omega$

**Measurement of Pt100:** ..... Three wire type, ( $\alpha=0.00385$ )

with compensation for cable length, excitation current of 0.170 mA

All input and output types are factory-calibrated. Thermocouples according to standard NBR 12771 / 99, RTD's NBR 13773 / 97.

**Heating Time:**..... 15 minutes

**INPUT DIGITAL (DIG INP):**..... Contact Dry or NPN open collector

**OUT1:**..... Voltage pulse, 5 V / 20 mA

**OUT2 (\*):**..... Relay SPST, 3 A / 250 Vac

**OUT3:**..... Relay SPST, 3 A / 250 Vac

(\* ) In models with adjustable outputs – PR, one relay SPDT-NO 10 A / 250 VAC is available at OUT2. These models will not be available the OUT3.

**USB INTERFACE:** 2.0, CDC CLASS (virtual communications port), MODBUS RTU protocol.

**SUITABLE FOR TERMINAL CONNECTION TYPE FORK**

**CYCLE PWM PROGRAMMABLE FROM 0.5 TO 100 SECONDS;**

**STARTS UP OPERATION:** after 3 seconds connected to the power supply.

## MAINTENANCE

### PROBLEMS WITH THE CONTROLLER

Connection errors and inadequate programming are the most common errors found during the controller operation. A final revision may avoid loss of time and damages.

The controller displays some messages to help the user identify problems.







MESSAGE	DESCRIPTION OF THE PROBLEM
----	Open input. No sensor or signal.
<b>Err1</b> <b>Err6</b>	Connection and/or configuration errors. Check the wiring and the configuration.

Other error messages may indicate hardware problems requiring maintenance service. When contacting the manufacturer, inform the instrument serial number, obtained by pressing the key  for more than 3 seconds.

### CALIBRATION OF THE INPUT







All inputs are factory calibrated and recalibration should only be done by qualified personnel. If you are not familiar with these procedures do not attempt to calibrate this instrument.



The calibration steps are:

- Configure the type of input to be calibrated.
- Configure the lower and upper limits of indication for the maximum span of the selected input type.
- At the input terminals inject a signal corresponding to a known indication value a little above the lower display limit.
- Access the parameter "**inLc**". With the keys  and  adjust the display reading such as to match the applied signal. Then press the  key.
- Inject a signal that corresponds to a value a little lower than the upper limit of indication.
- Access the parameter "**inUc**". With the keys  and  adjust the display reading such as to match the applied signal. Then press the  key.

**Note:** When checking the controller calibration with a Pt100 simulator, pay attention to the simulator minimum excitation current requirement, which may not be compatible with the 0.170 mA excitation current provided by the N120.

### CALIBRATION OF THE ANALOGICAL OUTPUT

- Configure I/O 5 for the current output to be calibrated, be it control or retransmission.
- In the screen "**ctrl**", program manual mode (**MAN**).
- Connect a current meter at the analog output.
- Enter the calibration cycle with the correct password.
- Select the screen "**ouLc**". Press the keys  and  for the controller to recognize the calibration process of the current output.
- Read the current indicated on the current meter and adjust the parameter "**ouLc**" to indicate this current value (use the keys  and 
- Select the screen "**ouUc**". Press the keys  and  for the controller to recognize the calibration process of the current output.
- Read the current indicated on the current meter and adjust the parameter "**ouUc**" to indicate this current value

The key  or  in order to leave the screen confirm the calibration

## WARRANTY

Warranty conditions are available on our web site [www.novusautomation.com/warranty](http://www.novusautomation.com/warranty).

## APPENDIX 1 - SOFTWARE LOGCHART-II

### INSTALLING LOGCHART-II

LogChart II is the software provided with the logger to allow for configuration and data offload. To install, run the **LC\_II\_Setup.exe** file provided with the CD.

**Note:** Be sure your Windows date separator is configured as a slash: dd/mm/yy or dd/mm/yyyy.

### RUNNING LOGCHART-II

When you open LogChart-II the main window is displayed:

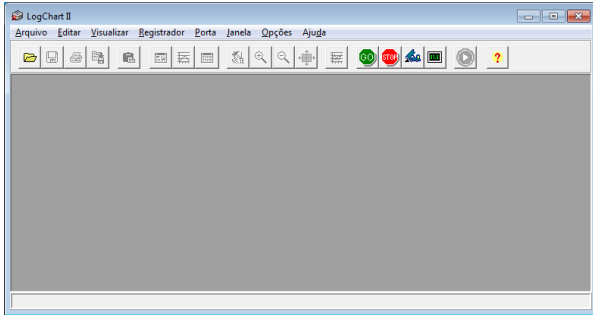

Fig. 1 – LogChart-II main window

Then indicate the serial port to be used by the communication interface through the "Porta" menu. This menu lists all available serial port on your computer. You must select a port that shows the N120 equipment in their description.

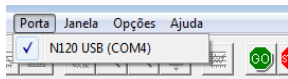

Fig. 2 – Selection of USB serial port where the N120 controller is connected.

Once a valid serial port is selected, the icons for communication with the controller will be activated.



Fig. 3 – Icons enabled when the communication port selected is a valid port

### CONFIGURING THE CONTROLLER



To configure the controller press the button:

The Configuration Settings window is displayed. This LogChart-II window allows the user to set the operating mode of the controller and also provide general information about the device (Fig. 4).

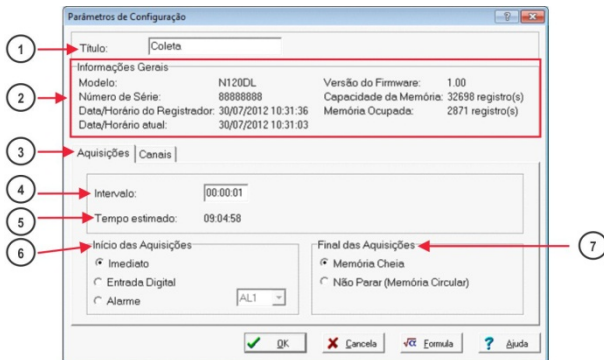

Fig. 4 – Logger Set Up (Readings)

The configuration fields are:

1 **Title:** In this field, the user identifies the records giving it a name (up to 16 characters).

2 **General Information:** Information field. There are presented information regarding the controller, including: Model (N120), serial number, date/time of the controller, current date/time of the PC, firmware version (model controller), memory capacity and number of acquisitions in memory.

In this field the time is constantly updated while the communication between controller and computer is established.

Note: The clock of the controller may be with a little difference compared to the current time of the computer. When the controller is configured their clock is updated.

3 **Acquisitions:** Presents a series of parameters that define how measurements will take place.

4 **Interval:** Defines the interval between readings: Minimum interval is 1 (one) second.

5 **Estimated time:** In this parameter, the logger informs the user how long it will take to occupy the full memory, in the conditions set up during configuration.

6 **Start of Readings:** Readings can be started in one of five different modes:

- **Immediately:** start as soon as programming is considered to be ready, and is then sent (OK) to the logger.
- **Digital Input:** The acquisitions are started whenever the digital input of the N120 is activated. Otherwise, the acquisitions are interrupted
- **Alarm:** the acquisition starts whenever the condition associated with the alarm 1 (AL1) controller is met. Otherwise, stops the acquisition.

7 **End of the acquisitions:** The options for the ending of acquisitions are:

- **Memory Full:** acquisitions are made up to the capacity of the memory available.

**No Stop (Circular Memory):** acquisitions happen continuously, overwriting the oldest registers as the number of acquisitions exceeds the memory capacity.

8 **Channels:** Shows parameters referring to each channel separately. Channel 1 is the Temperature channel, and Channel 2 the Relative Humidity channel.

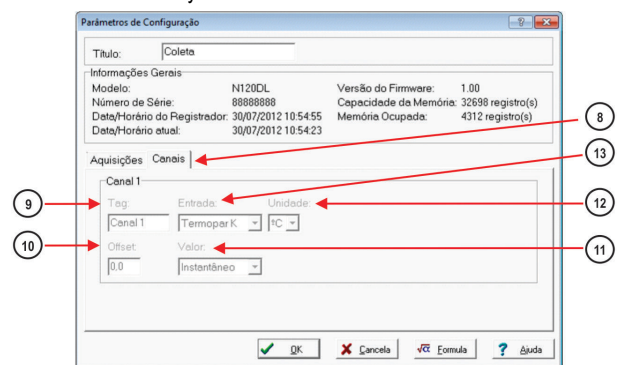

Fig. 5 – Logger Set Up (Channels)

9 **Tag:** Defines a name for the temperature registers.

10 **Offset:** Makes possible to correct the value logged.

11 **Valor:** It defines how the value measured will be registered.

12 **Unit:** Defines the unit of the value measured: °C or °F for channel 1 (temperature).

13 **Entrada:** The alarm limit value is shown with a dotted line with the same color of the channel 1.

After filling all the fields select "OK", and the configuration will be sent to the logger.

Important: Setting the N120 will erase all the records present in its data memory.

## COLLECTING DATA AND VIEWING

The data acquired by the controller can be transferred to a PC using the LogChart-II software, which presents in graphical and table form. The data can be saved in files for future analysis and comparisons.

### COLLECTING THE DATA



The collection of the acquired data is done by clicking on icon **Collect Acquisitions**. During the process of data transfer, a progress bar is shown, indicating how much has already been transferred. The data transfer time is proportional to the number of acquisitions made.

### VIEWING THE DATA COLLECTED

After the transfer of the acquisitions, the data are displayed in graphical form.

### Chart Window



You can select a region of the graph to be viewed in detail (zoom). The zoom commands can be accessed through View menu or through the zoom icons on the toolbar.

You could also select the chart area to be enlarged through click and drag the mouse, creating a zoom region from the upper left corner of the desired graph.

In the chart window the minimum and maximum values of channel 1 are shown. Shows also a dashed horizontal line with the value set for the alarm.

When selecting a point on the curve by double clicking it shows the value corresponding to the point on the curve graphic and the acquisition table.

When selecting a point on the curve with a double click with the Shift key, you can associate a text to the point of the curve.

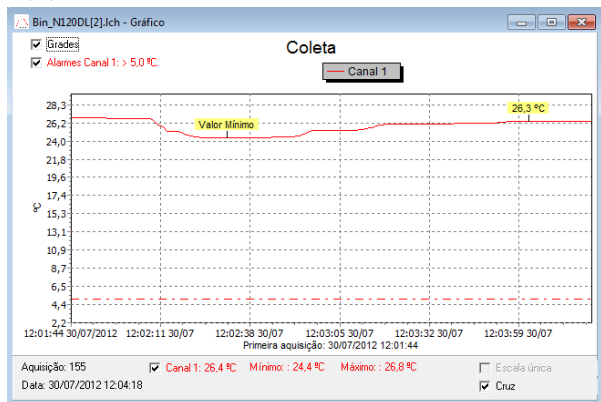

Fig. 6 - Graphical display of the collected data

The collecting **does not** stop the acquisition process of measurement and data recording.

### Acquisition Table Windows



The presentation in tabular form can be obtained by pressing the Show Table of Acquisitions. This mode displays the values acquired in a table format by relating the time of the measurement, the date and its value (Fig. 7).

When selecting a table row with a double click this line is marked (yellow) and the corresponding point on the curve graphic collection value is showed.

Nº Aquisição	Horário	Data	Canal 1 [°C]
00001	12:01:44	30/07/2012	26,8
00002	12:01:45	30/07/2012	26,8
00003	12:01:46	30/07/2012	26,8
00004	12:01:47	30/07/2012	26,8
00005	12:01:48	30/07/2012	26,8

Fig. 7 – Acquisition Table

### General Information Window



This window displays information about the controller whose acquisitions were recently collected and its configuration. This screen can be displayed via the **View General Information** icon.

At the end of the *General Information* window (Fig.8), can be added a text with comments on the data collected.

Informações Gerais	
<b>Registrador</b>	
Modelo:	N120DL
Número de Série:	88888888
Versão do Firmware:	1.00
Capacidade de Memória:	32698 aquisições
<b>Canal 1 [°C]</b>	
Entrada:	Termopar K
Valor:	Aquisições por valor instantâneo
Offset:	0
Alarme Inferior:	Indefinido
Alarme Superior:	5,0
Fórmula:	Nenhuma
<b>Informações da Coleta</b>	
Título:	Coleta
Intervalo entre aquisições:	1 s
Número total de aquisições:	158
Início das Aquisições:	Imediato
Final das Aquisições:	Memória Cheia
Momento da coleta:	segunda-feira, 30 de julho de 2012 às 12:04:21
Primeira aquisição:	segunda-feira, 30 de julho de 2012 às 12:01:44
Digite aqui um comentário para identificação dos dados coletados.	

Fig. 8 – General Information

## DETERMINATION AND SELECTION OF SERIAL (COM) - WINDOWS

### DETERMINATION

The serial port associated with the N120 is automatically determined by the operating system a few moments after connecting the N120. The user can easily identify or change the COM port associated with the N120 accessing the "**Device Manager**" in Windows®.

### Control Panel / System / Hardware / Device Manager / Ports COM & LPT

You can also open the "**Device Manager**" by running the following command: "devmgmt.msc".

After opening the "**Device Manager**" you can check which port Serial (COM) associated with the N120. As can be identified in Fig. 9a and Fig.9b, the N120 is associated with COM7.

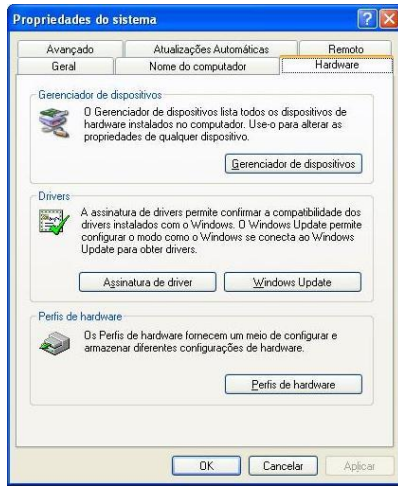

Fig. 9a – Determining the COM port.

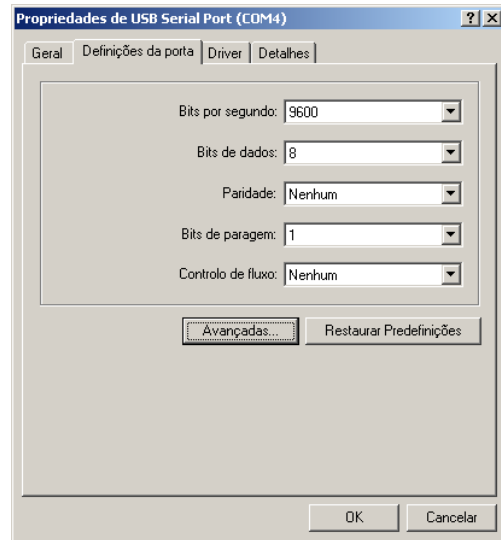

Fig. 10b - Accessing Advanced COM port setting.

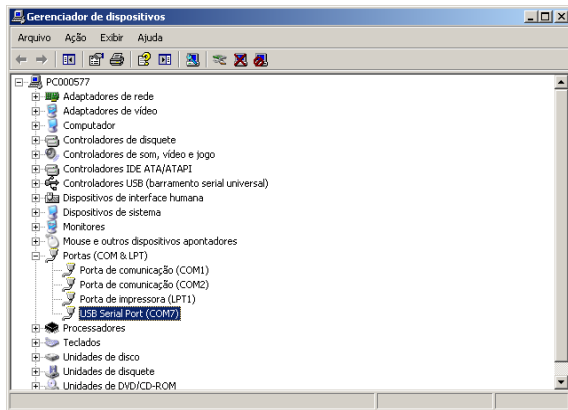

Fig. 9b - Determining the COM port.

### IMPORTANT RECOMMENDATION

To improve communication of the USB interface is recommended to set the Latency Timer. This parameter can be modified by accessing the "Advanced Settings for COMx" as Fig. 10a and Fig. 10b window.

As shown in Fig. 11, the "Latency Timer (ms)" parameter must be set to value 4.

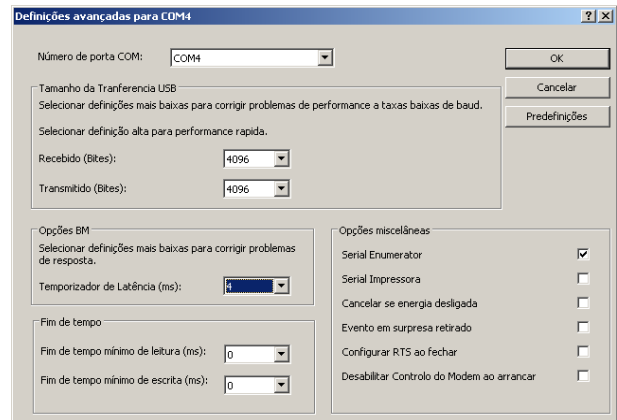

Fig. 11 – Advanced Settings for COM

### SELECTION

If necessary modify the Serial Port (COM) associated with the N120 select the "USB Serial Port (COM X)" where is connected the N120. Go to "Action / Properties" and in the "Port Settings" then click "Advanced ..." tab, as Fig. 10a and Fig. 10b. If this tab does not appear, the driver was not installed properly and you should reinstall the software DigiConfig. In the "Advanced Settings for COMx" window change the "COM Port Number" parameter to the desired COM number, as shown in Fig. 11. Some serial ports can be marked as being in use (In Use). Just select one of these ports if you are sure that it is not being used by any other peripheral of your computer.

In some situations the serial ports can be marked as in use even when the associated device is not installed on your computer. In this case it is safe to connect this port to the N120.

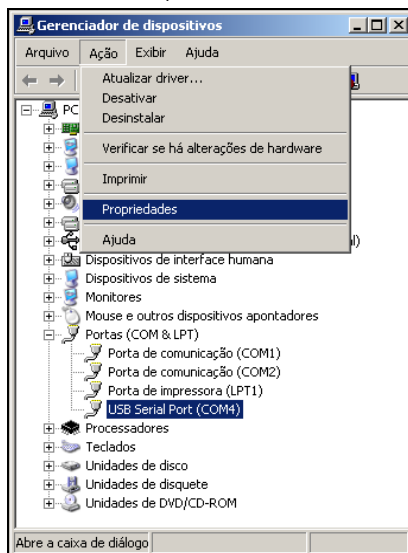

Fig. 10a - Accessing Advanced COM port setting.

## ANEXO 2 –SERIAL COMMUNICATION

The controller can be supplied with an asynchronous RS-485 digital communication interface for master-slave connection to a host computer (master). The controller works as a slave only and all commands are started by the computer which sends a request to the slave address. The addressed unit sends back the requested reply. Broadcast commands (addressed to all indicator units in a multidrop network) are accepted but no reply is sent back in this case.

### CHARACTERISTICS

- Signals compatible with RS-485 standard. MODBUS (RTU) Protocol. Two wire connection between 1 master and up to 31 (addressing up to 247 possible) instruments in bus topology. The communication signals are electrically insulated from the rest of the device;
- Maximum connection distance: 1000 meters.
- Time of disconnection for the controller: Maximum 2 ms after last byte.
- Selectable speed; 8 data bits; 1 stop bit; selectable parity (no parity, pair or odd);
- Time at the beginning of response transmission: maximum 100 ms after receiving the command.

The RS-485 signals are:

<b>D1</b>	<b>D</b>	<b>D +</b>	<b>B</b>	Bi-directional data line.	Terminal 16
<b>D0</b>	<b>D̄</b>	<b>D -</b>	<b>A</b>	Bi-directional inverted data line.	Terminal 17
<b>C</b>				Optional connection that improves the performance of the communication.	Terminal 18
<b>GND</b>					

### CONFIGURATION OF PARAMETERS FOR SERIAL COMMUNICATION

Two parameters must be configured for using the serial type:

**bAud**: Communication speed.

**Prty**: Parity of the communication.

**Addr**: Communication address for the controller.

### REDUCED REGISTERS TABLE FOR SERIAL COMMUNICATION

#### COMMUNICATION PROTOCOL

The MOSBUS RTU slave is implemented. All configurable parameters can be accessed for reading or writing through the communication port. Broadcast commands are supported as well (address 0).

The available Modbus commands are:

- 03 - Read Holding Register      06 - Preset Single Register  
 05 - Force Single Coil          16 - Preset Multiple Register

#### HOLDING REGISTERS TABLE

Follows a description of the usual communication registers. For full documentation download the Registers Table for Serial Communication in the N120 section of our web site.

Address	Parameter	Register Description
0000	Active SP	Read: Active control SP (main SP, from ramp and soak or from remote SP). Write: to main SP. Range: from <b>SPLL</b> to <b>SPHL</b> .

0001	PV	Read: Process Variable. Write: Not allowed. Range: Minimum value is the one configured in <b>SPLL</b> and the maximum value is the one configured in <b>SPHL</b> . Decimal point position depends on <b>dPPa</b> value. In case of temperature reading, the value read is always multiplied by 10, independently of <b>dPPa</b> value.
0002	MV	Read: Output Power in automatic or manual mode. Write: Not allowed. See address 28. Range: 0 to 1000 (0.0 to 100.0 %).