



LogBox-AA

ELECTRONIC DATA LOGGER - MANUAL V1.1x G

PRESENTATION

LogBox-AA is an electronic data logger with two analog input channels. Values measured by these channels (data) are stored in the logger electronic memory (acquisitions) for later download to a PC for visualization and analysis in the form of tables or graphs. Data can be easily exported to spreadsheets.

The **LogChart-II** is the software used to configure the logger, download and visualize data. The logger configuration allows define the logger operation mode, including the start/stop time of data acquisition. Other parameters such as signal input type, Logging interval, etc., are easily selected through the **LogChart-II** software.

The **LogBox-AA** also provides a signal for commanding an external power supply (battery) of a device connected to the logger. This feature allows that external devices, such as a transmitter, be powered only during the measurement sample time, thus extending the service life of these external batteries.

MEMORY CAPACITY

- 64 k Model: Allows up to 64.000 records.

Memory capacity is always shared between enabled channels. In case there are two channels enabled, each gets 50 percent of the memory available. When only a single channel is enabled, it has the entire memory at its disposal.

Memory capacity is indicated on the identification label placed on the logger case.

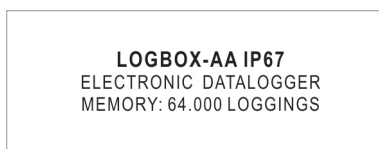

Fig. 1 –Identification label

INPUT SIGNALS

The input channels 1 and 2 measure analog electric signals, which can be Pt100, Thermocouple (J, K, T, E, N, R, S or B), voltage (0 to 50 mV or 0 to 10 V) or current (0 to 20 mA or 4 to 20 mA), according to user-defined settings.

Note: Besides configuration performed through the software, the definition of input signal requires two internal jumpers to be configured.

DATA ACQUISITION (LOGGING)

Data can be acquired through different modes. The logger can be configured to perform a single measurement within a time interval storing the value read or perform ten measurements within the time interval and store the mean of values measured. Yet, it can store the minimum or maximum values read in the interval.

OPERATION

The logger operation mode is user-defined in the **LogChart-II** software. To access or change this configuration, the **IR-LINK3** interface is required. The user must install the LogChart-II software in a computer and run the logger configuration according to instructions defined in the LogChart-II installation section of this manual.

After configuration and input electric connections are made, the device is ready to measure and log input signals. The status indicator shows the logger current status.

STATUS INDICATORS (LEDS)

The Status Indicators (see Fig. 2) are located in the logger front panel. They indicate the current working conditions of the unit.

LOG Indicator (Logging): While in stand-by (not logging) or after a series of acquisitions is ended, it flashes once at every four seconds. During login it flashes twice at every four seconds.

AL Indicator (alarm): Alerts the user regarding alarm conditions. Whenever an alarm situation takes place it will flash once at every four seconds, until a new configuration is applied to the logger.

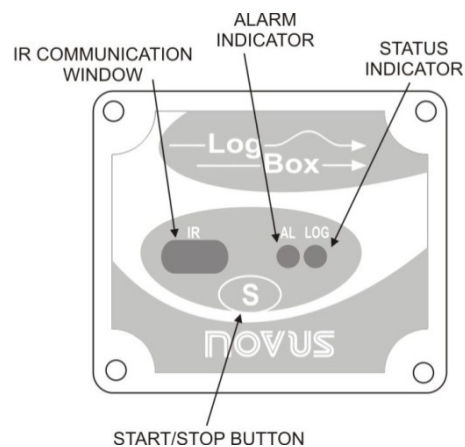

Fig. 2 – LED Indicators and IR communication

LOGCHART-II

INSTALLING LOGCHART-II

The LogChart II is the software provided with the logger to allow for configuration and data collection. To install the LogChart II, execute the **LC_II_Setup.exe** program available on our website. The installation wizard will then guide you throughout the installation process.

RUNNING LOGCHART-II

Start the program. The main window will appear on the screen, as in Fig. 3.

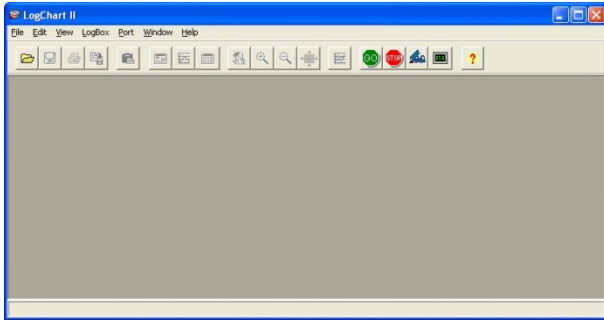

Fig. 3 – LogChart-II main window

The LogChart II requires a communication port to talk to the logger. Select one and connect the corresponding wand IR-LINK3 to it. Click on the menu **Port**. Clicking on the menu **Port**, all free communication ports available in the computer will be listed. The chosen port will be remembered next times the LogChart II is initiated.

When the selected port is successfully opened, the LogChart II initial screen is opened, enabling the buttons below:



Fig. 4 – Buttons enabled when the communication port of choice is valid

In case the user wants to stop the process while data logging is running, the button “Stop” must be pressed:



OPTIC INTERFACE IR-LINK3

Configuring, monitoring or downloading data from the logger through LogChart-II requires that the IR-LINK3 communication interface be connected to your PC. This interface is sold separately.

The IR-LINK3 interface sends and receives data to/from the logger through infrared signals. Windows will request the proper driver installation, which is found on our website. After installation is completed, the IR-LINK3 interface is recognized whenever it is connected to the PC.

After the USB driver installation, the LogChart II must be opened again. In the “Port” menu, choose the same port selected for the optical interface communication using the menu **Port**.

CONFIGURING THE LOGGER

Make sure the IR-LINK3 wand is connected to the PC port selected. The interface must be pointed towards the logger communication window (see Figure below) at a distance of about 15 cm.

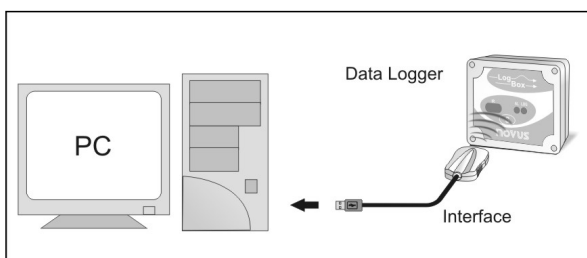



Fig. 5 – Infrared interface position

Click the  button to start the communication between the logger and the software; the **Parameters Configuration** window is then displayed (Fig. 6), showing the current configuration and information about the logger. New configuration parameters defining the operation mode for a new application can be entered. The user can also obtain general information about the device.

The fields of the configuration window are described below.

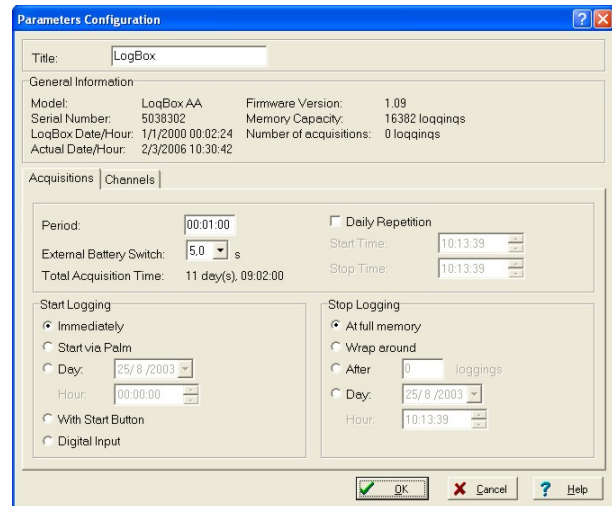

Fig. 6 – Configuration window

GENERAL INFORMATION FIELD

General information on the top of the screen informs the model, serial number, logger current date/time, PC date/time, firmware version (logger model version), memory capacity and used memory. This information is displayed in the upper part of the LogChart-II configuration screen.

The time is constantly updated in this screen, provided that the logger and the PC are communicating.

ACQUISITIONS FIELD

Interval: It determines the interval between readings in the hh:mm:ss format. New data is stored in the logger memory after each time interval.

In the **Instantaneous** reading mode, the value of the interval between acquisitions is the same as the time interval between measurements. For **Average**, **Minimum** and **Maximum** readings, the logger executes 10 readings within this interval.

External Battery Switch time: Defines the time when the logger turns on the power supply, before proceeding with any reading. This time is limited to 10 seconds and must be less than half of the interval between readings.

Estimated time: It informs the estimated time for the accomplishment of programmed readings based on the logging “Interval” and on the number of programmed readings.

Daily Repetition: Allows loggings to be repeated every day, for example, recording data from 8 AM to 5 PM day after day. The start and stop times are defined in the fields “Start time” and “Stop time.”

START LOGGINGS FIELD

Immediately: The logger starts logging as soon as the configuration is applied. Not valid when the option ‘Daily Repetition’ is selected.

Day / Hour: Logging starts at a defined date and time. The date defined is used for the Daily Repetitions option as well.

Through Start Button Starts and stops logging by pressing the Star button for two seconds.

Digital Input: Starts readings when the digital input is activated (closed) and stops readings when the digital input is deactivated (open).

STOP LOGGINGS

At Full Memory: Loggings can be stored up to the full memory capacity is reached.

Wrap around: Logging never stops. The **LogBox-AA** will keep on recording the readings and when the memory is full it will overwrite the oldest record in a circular or wrap around manner.

After a defined number of readings: The logger will stop logging after the number of readings here defined is reached. Not valid when the option ‘Daily Repetition’ is selected.

Day / Hour: The **LogBox-AA** will stop logging at the user-defined date and time. Not valid when the option 'Daily Repetition' is selected.

CHANNELS FIELD

By selecting the "Channels" option, the user is able to choose the individual settings for each input channel, as Fig. 7 shows.

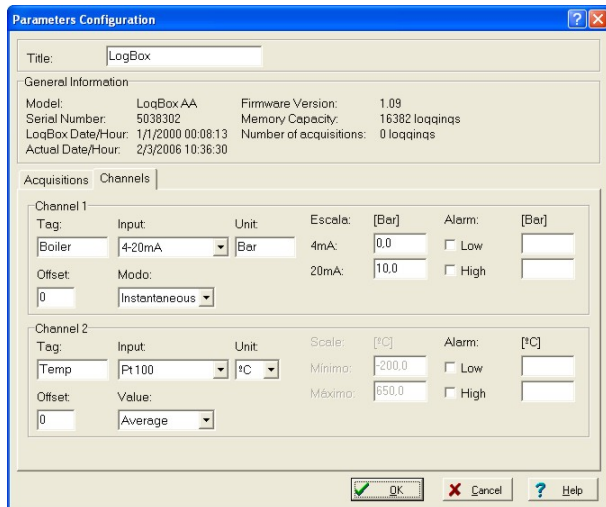

Fig. 7 – Parameters for Input Channels Configuration

Such parameters are:

Tag: Defines a name (up to 8 characters) for identifying the variable to be measured.

Inputs: The signal applied to the logger second input is defined here. The list shows all the input options available. The selected option must be in accordance with the internal configuration of the jumper, as Table 1 shows.

Unit: Defines the variable unit.

Scale: Defines the range, in engineering units, for representing the input variable measured.

Adjustable from -32000 to +32000 for 4-20 mA, 0-20 mA, 0-50 mV and 0-10 inputs, for the remaining input times the scale is fixed.

Offset: Allows fine offset corrections on the measured value.

Value: Defines readings recording mode:

- **Instantaneous:** The instant value read at the logging time.
- **Average:** Ten readings at each reading interval. The average value of readings is the value recorded.
- **Minimum:** Ten readings at each reading interval. The lowest value found is recorded.
- **Maximum:** Ten readings at each reading interval. The highest value found is recorded.

Alarm: defines a limit range of variables measured that, once exceeded, trigger the alarm.

Once activated, the alarm LED indicator stays so even after the alarm-triggering situation has ceased.

LOW defines the minimum value under which the alarm is triggered; HIGH defines the maximum value above which the alarm sensor is triggered.

After filling all the fields, send the configuration to the logger by clicking on the button

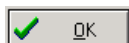

New settings and PC current date/time are then sent to the logger.

ELECTRICAL CONNECTIONS

Only the input connections and the External Battery Switch (when used) are needed. The logger is exclusively powered by its internal battery.

In the IP65 models, the inputs and the signal for activating the external power supply are located inside the logger case, which must be opened for accomplishing the connections.

In the IP67 model, proper connectors are provided for this purpose, as shown in Fig. 9.

IP65 MODEL

Open the logger's cover to get access to the block terminals and the configuration jumpers. Connection cables must pass through the compress fitting located at the bottom of the case. Fig. 8 shows the internal terminals distribution.

Channel 1:	CN1 connector – Terminals 1, 2 and 3
Channel 2:	CN1 connector – Terminals 4, 5 and 6
External Battery Switch	CN2 connector – Terminals 7, 8 and 9
Digital Input	CN2 connector – Terminals 7, 10 and 9

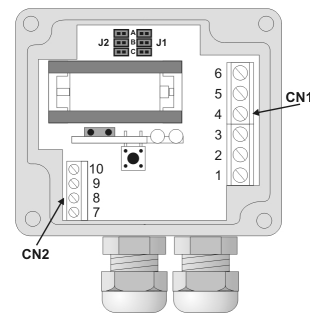

Fig. 8 – IP65 connections internal view

Note: Make sure that the compress fitting is perfectly tightening the cables, thus assuring proper IP65 protection: (totally dust-tight and protected against water jets).

IP67 MODEL

In the IP67 version, an M8 connector is provided for signal input. Two connectors provide external access to the input channels, as shown in Fig. 9. The cables are supplied with the logger.

Note: The case cover should not be opened unless battery replacement is required. If this is the case, the cover must be properly tightened back in its place such as to assure the IP67 protection.

IP67 - Totally dust-tight and protected from temporary immersion in water.

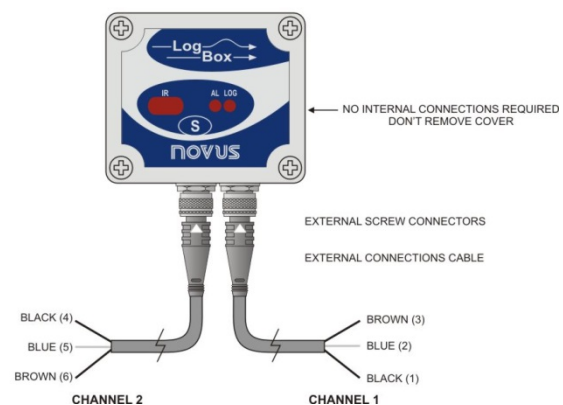

Fig. 9 – IP67 external connectors

Wire connections:

Channel 1 cable (right)	Connection
Brown	CN1 – 3
Blue	CN1 – 2
Black	CN1 – 1

Channel 2 cable (left)	Connection
Brown	CN1 -6
Blue	CN1 – 5
Black	CN1 – 4

INPUT CONNECTIONS

Both models have the same input connections schema:

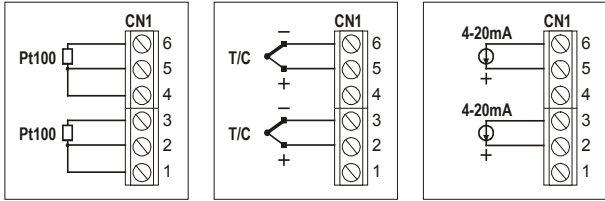

Fig. 10 – Input signal connections

Before using the logger, the internal jumpers positioning must be set according to the input type used.

The factory setting of these jumpers is for measurement of Pt100 / Thermocouple / 0-50mV signals.

Figures below show some positioning for possible input types.

Input signal	CHANNEL 1 J1 position	CHANNEL 2 J2 Position
4-20 mA / 0-20 mA	A	A
Pt100 / Thermocouple / 0-50 mV	B	B
0-10 V	C	C

Table 1 – J1 and J2 positioning

EXTERNAL BATTERY SWITCH

The example in (Fig. 11) below shows the usage of the external battery switch for commanding the power supply of external devices. Channel 1 is configured to 4-20mA input signal. A battery is used to provide power to the 4-20 mA loop. The battery switch "turns on" the power to the loop a moment (defined in the configuration) before the measurement is taken, enabling the transmitter (pressure, temperature, etc) to start up and stabilize the output.

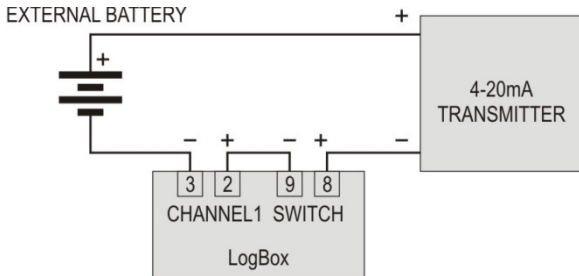

Fig. 11 – Ex. of using the external drive to a channel

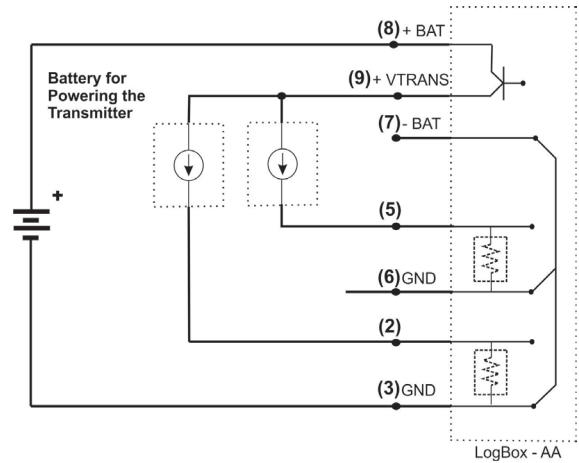

Fig. 12 – Ex. of using the external drive for two channels

DIGITAL INPUT (DI)

The Digital Input that can be used to guide the logger readings is available in terminals 7 (-) and 10 (+) of CN2.

INSTALLATION RECOMMENDATIONS

Signal wires should be installed in grounded conduits and away from power or contactor wires.

Instruments must be powered only by an exclusive power supply.

System failure should always be taken into account when designing a control panel to avoid irreversible damage to equipment or people.

Installing RC filters (47 R and 100 nF, serial) is strongly recommended at contactor coils or any other inductors.

OFFLOADING AND DATA VISUALIZATION

The transference of data to a PC is accomplished by using the LogChart II software. Data can be collected anytime and saved in files for future analysis (menu "File Save" or "File Save as"). Help can be accessed from the LogChart-II software when necessary.

Offloading data: data offload is accomplished by clicking on the button:



Or using the LogChart-II menu. During data transference, a status bar indicates remaining data to be transferred. Data offloading time is proportional to the number of readings logged. At the end of data transference, the Graph window is displayed.

Graph window

The Graph is a convenient tool for analysis. It enables the logger acquisitions to be read in the form of a "values x time" graph. As one moves the mouse in the chart area, the time and the value of the records of each channel are shown in the field located in the bottom of the window.

Zooming in and out are implemented. It is possible to select an area by clicking and dragging the mouse, thus creating a zoom region, starting at the upper left position of the region of interest.

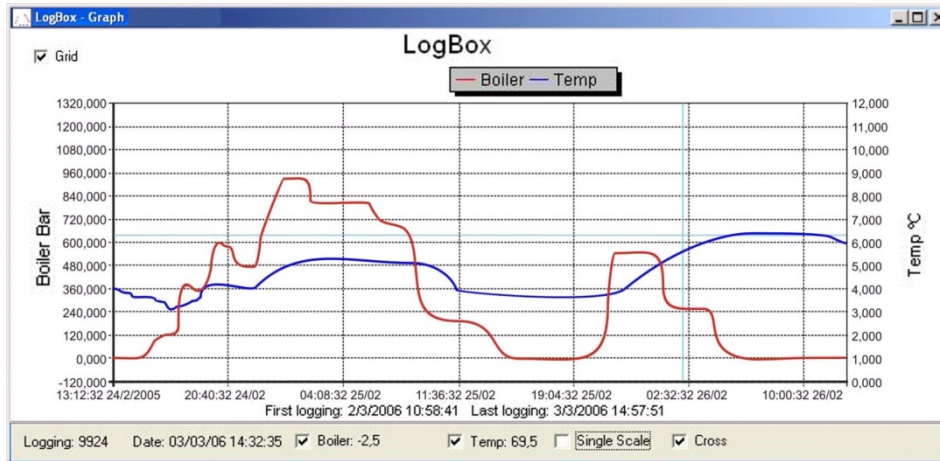

Fig. 13 - Graph window.

NOTE

The command **Offload acquisitions** does not interrupt the process of data logging and reading.

Other two windows can be easily opened: General information window and Tables window.

General information table

Displays information about the logger that registered data: its features and configurations, and details about data acquired.

General Information	
LogBox	
Model:	LogBox AA
Serial Number:	5038302
Firmware Version:	1.09
Memory Capacity:	16382 loggings
Boiler [Bar]	
Input:	4-20mA
Value:	Instantaneous Value
Offset:	0
Temp [°C]	
Input:	Pt 100
Value:	Instantaneous Value
Offset:	0
Logging Information	
Title:	LogBox
Interval between readings:	10 sec
Total Number of Loggings:	10076
Start Logging:	Immediately
Stop Logging:	At full memory
Download Time:	quinta-feira, 2 de março de 2006 at 13:47:29
First logging:	quinta-feira, 2 de março de 2006 at 10:58:41
Last logging:	sexta-feira, 3 de março de 2006 at 14:57:51

Fig. 14 - General Information window

Acquisitions Table Window

Data acquired by one or both input channels (user-defined) are displayed in engineering units in a table format. The table displays register number, date/time and the record values.

Record Nr.	Time	Date	Boiler [Bar]	Temp [°C]
02852	18:53:51	2/3/2006	10,6	69,3
02853	18:54:01	2/3/2006	10,6	69,2
02854	18:54:11	2/3/2006	10,6	69,2
02855	18:54:21	2/3/2006	10,6	69,2
02856	18:54:31	2/3/2006	10,6	69,2
02857	18:54:41	2/3/2006	10,6	69,2
02858	18:54:51	2/3/2006	10,6	69,2
02859	18:55:01	2/3/2006	10,6	69,2
02860	18:55:11	2/3/2006	10,6	69,2
02861	18:55:21	2/3/2006	10,6	69,2
02862	18:55:31	2/3/2006	10,6	69,2
02863	18:55:41	2/3/2006	10,6	69,2
02864	18:55:51	2/3/2006	10,6	69,2
02865	18:56:01	2/3/2006	10,6	69,2
02866	18:56:11	2/3/2006	10,6	69,2
02867	18:56:21	2/3/2006	10,6	69,3
02868	18:56:31	2/3/2006	10,6	69,3
02869	18:56:41	2/3/2006	10,6	69,2
02870	18:56:51	2/3/2006	10,6	69,2
02871	18:57:01	2/3/2006	10,6	69,2
02872	18:57:11	2/3/2006	10,6	69,2

Fig. 15 – Screenshot showing the acquisitions table

VISUALIZING THE DATA

Three windows support data visualization: Graph, Acquisitions Table and General Information windows. Data can be originated from direct reading from the logger or from a file previously recorded in a computer.

Once the windows are open, data can be saved in a file (.lch), printed on a graph or exported to a text file (.txt or .dat).

MONITORING ACQUISITIONS

To visualize current measurements in a graph format, use the *Monitor On-Line* (Fig. 16) command by clicking on the button:



while pointing the IR-LINK3 interface to the logger.

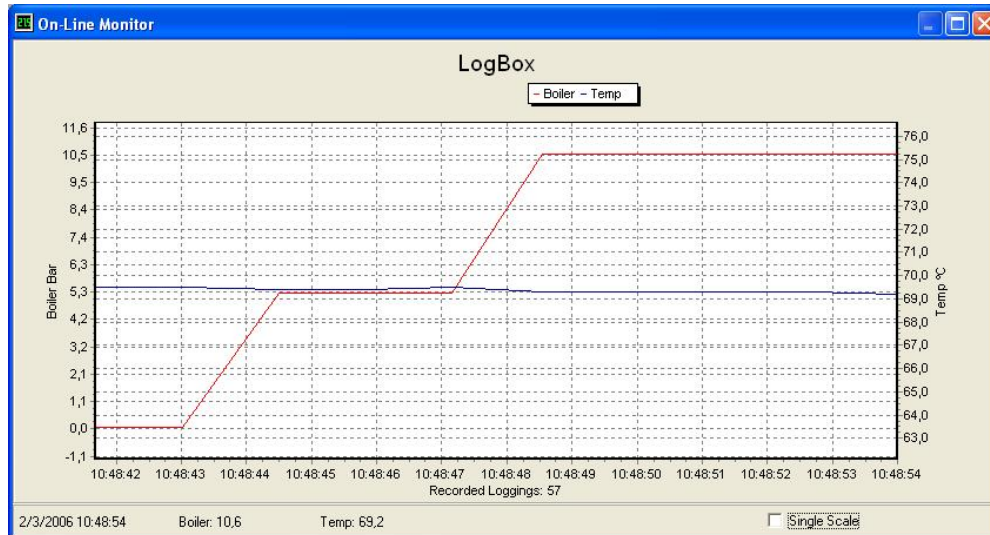

Fig. 16 – Online monitoring graph

OBSERVATIONS

The logger is an electronic device and some basic care is required:

- When opening the device for battery replacement or connecting sensors avoid touching the circuit for not causing damages resulting from static electricity.
- When the device is opened, avoid liquid and/or dust contact.
- Use a screwdriver to open the case cover.
- Pay attention to batteries polarity: The positive terminal should be placed directed towards the center of the device.
- Worn batteries should not be recharged, dismantled or incinerated. After use, batteries must be disposed according to local legal rules or returned to Novus.
- After placing batteries back to the logger, make sure the cover is firmly attached to the socket.

MOST FREQUENTLY PROBLEMS

The LED is not flashing.

The LED flashing light is intentionally weak, and it can be difficult to see it in illuminated environments. Make sure it is not flashing at all.

Make sure the battery is installed correctly;

Make sure the battery is not discharged;

Communication with the logger fails

Make sure the COMM port is selected correctly and there is no other program using the same port during communication attempts;

Make sure there is no physical obstacle blocking the infrared signal;

Make sure the cable is well connected to the PC port;

Make sure the port selected does not present any problem;

ADDITIONAL INFORMATION

If you have any doubt concerning this or other NOVUS products, e-mail us at info@novusautomation.com or visit our home page: www.novusautomation.com

SPECIFICATIONS

Inputs:

Thermocouples according to the NBR 12771/99 standard;

Pt100 RTD's NBR 13773/97.

TYPE	CHARACTERISTICS
J	Range: -50 to 760 °C (-58 to 1400 °F)
K	Range: -90 to 1370 °C (-130 to 2498 °F)
T	Range: -100 to 400 °C (-148 to 752 °F)
N	Range: -90 to 1300 °C (-130 to 2372 °F)
R	Range: 0 to 1760 °C (32 to 3200 °F)
S	Range: 0 to 1760 °C (32 to 3200 °F)
B	Range: 150 to 1820 °C (32 to 3308 °F)
Pt100	Range: -200.0 to 650.0 °C (-328 to 1202 °F)
0-50 mV *	Linear. Programmable range of -32768 to 32767
4-20 mA *	Linear. Programmable range of -32768 to 32767
0-20 mA *	Linear. Programmable range of -32768 to 32767
0-10 Vdc *	Linear. Programmable range of -32768 to 32767

(*) **Software ranges allowed:** 0 to 65535, 65535 to 0, -32768 to 32767, 32767 to -32768.

Input resistance: 0-50 mV, Pt100 and thermocouples: >10 MΩ

0-10 V: > 1 MΩ

0 to 20 mA and 4 to 20 mA: 100 Ω + 2 Vdc

Accuracy: Thermocouple J, K and T: 0.25 % of max. range ±1 °C;

Thermocouple N, R, S, B: 0.25 % of max. range ±3 °C;

Pt100: 0.2 % of the max. range;

mA, mV and V: 0.2 % of the max. range.

Memory capacity: 64.000 (64 k) loggings.

Interval between readings: Minimum: 1 second, maximum: 18 hours

External battery switch time: 3.6 V lithium battery (1/2 AA)

Typical battery life: 200 days with one weekly download and 5 minutes measuring interval. Battery life depends heavily on data retrieval frequency.

Working temperature: From -40 °C to 70 °C.

Protection: IP65 and IP67 models (see lateral label on product)

Material: ABS with polycarbonate film case; Polycarbonate film

Dimensions: 60 x 70 x 35 mm

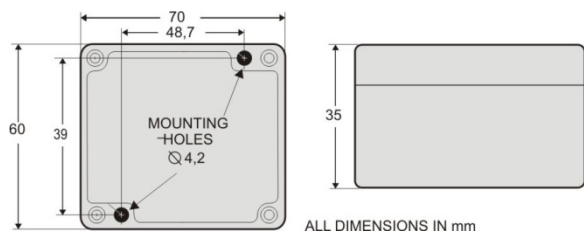

PACKAGE CONTENTS

Besides this manual, the user must check if the items below accompany the product.

- The electronic logger **LogBox-AA**;
- Two cables for sensor wiring (IP67 model only).

WARRANTY

Warranty conditions are available on our website www.novusautomation.com/warranty.