

**ENG**

# Model 2604

High performance controller/programmer

User Guide



---

# MODEL 2604 CONTROLLER

## USER GUIDE

<b>Contents</b>	<b>Page</b>
<b>Chapter 1 INTRODUCTION</b>	<b>1-1</b>
<b>Chapter 2 INSTALLATION</b>	<b>2-1</b>
<b>Chapter 3 OPERATION</b>	<b>3-1</b>
<b>Chapter 4 PROGRAMMER OPERATION</b>	<b>4-1</b>
<b>Chapter 5 ALARM OPERATION</b>	<b>5-1</b>
<b>Appendix A ORDER CODE</b>	<b>A-1</b>
<b>Appendix B SAFETY AND EMC INFORMATION</b>	<b>B-1</b>
<b>Appendix C TECHNICAL SPECIFICATION</b>	<b>C-1</b>

---

**Issue Status of this Manual**

<b>Section</b>	<b>Issue</b>
Contents	4.0
Chapter 1	4.0
Chapter 2	3.0
Chapter 3	4.0
Chapter 4	3.0
Chapter5	3.0
Appendix A	4.0
Appendix B	3.0
Appendix C	4.0

## Notes

1. Section are up-dated independently and so may be at different issues
2. The Contents section and the manual as a whole always take the issue number of the most recently up-dated section
3. This issue applies to software version 5.1 or greater
4. Appendix C is updated to include DeviceNet in the EMC specification

---

<b>1.</b>	<b>Chapter 1 INTRODUCTION .....</b>	<b>2</b>
1.1.	<b>WHAT IS 2604.....</b>	<b>2</b>
1.2.	<b>BEFORE YOU BEGIN .....</b>	<b>3</b>
1.2.1.	Unpacking.....	3
1.2.2.	Contents of Packaging.....	3
1.2.3.	Does the Controller Match the Process?.....	3
1.3.	<b>OPERATOR INTERFACE - OVERVIEW .....</b>	<b>5</b>
1.3.1.	LED Status Indicators.....	6
1.3.2.	Operator Buttons .....	7
1.4.	<b>INSTALLATION - OVERVIEW .....</b>	<b>8</b>
1.5.	<b>I/O MODULES .....</b>	<b>9</b>

# 1. Chapter 1 INTRODUCTION

Thank you for selecting the 2604 High Performance Programmer/Controller.



This controller can be supplied or can be fully configured to be process specific.

**It is important to note, therefore, that the actual displays shown in this guide may not be identical to those shown on your controller.**

This guide, therefore, is intended to describe the **principle** of operation and installation of the controller, and is intended as a 'Getting Started Guide'.

A detailed Engineering Handbook is also available, part no. HA026761, for those wishing to configure and commission the controller.

## 1.1. WHAT IS 2604

The 2604 is a modular, fully configurable, high accuracy, high stability temperature and process controller which is available in a single, dual or three loop format.

It is supplied in accordance with an ordering code which can be found printed on a label on the side of the instrument case. A description of the order code is given in Appendix A of this guide and should be checked with that shown on the label.

It has a dual 7-segment display of process value and setpoint with a LCD panel for display of information and user defined messages.. The user interface is menu driven via the display and seven front panel keys.



**Figure 1-1: General View of 2604 Controller**

Features include:

- Advanced ramp/dwell programmer with storage of up to 50 programs.
- Application specific controllers such as Carbon Potential, Humidity and Melt Pressure
- A wide variety of inputs which can be configured, including thermocouples, Pt100 resistance thermometers and high level process inputs.
- Each loop can be defined to be PID, On/Off or motorised valve position and can control using a variety of strategies including single, cascade, override and ratio control.
- PID control outputs can be relay, logic, triac or dc with motorised valve position outputs being relay triac or logic.
- Auto tuning and PID gain scheduling are available to simplify commissioning and optimise the process

## 1.2. BEFORE YOU BEGIN

### 1.2.1. Unpacking

The packaging is designed to withstand reasonable transit shocks. It is suggested that each item is unpacked carefully and the contents inspected for damage.

If there is evidence of shipping damage, please notify your supplier within 72 hours. The packaging should be retained for inspection.

All packaging contains anti-static materials to prevent the build up of static which can damage electronic assemblies.

### 1.2.2. Contents of Packaging

Each box contains the following parts:-

1. The 2604 controller fitted into its corresponding sleeve. Labels on the sleeve identify the controller code, its serial number, and the customer reference number. These details should be checked against your requirements before installing the unit into the panel.
2. Two panel retaining clips
3. Burden resistors for use with mA inputs
4. This User Guide

Please refer to Figure 1-2 showing a general view of the controller.

### 1.2.3. Does the Controller Match the Process?

Every controller is supplied with a specific hardware configuration to match the process which it is designed to control. For example, there are five 'slots' which can contain different plug in modules. These are defined by a hardware code as shown in Appendix A. Before installing the 2604 controller check the label on the side of the instrument against the instrument coding given in Appendix A for correct type.

Where possible the controller is supplied with its software configured to match the process. This is defined by a quick start order code given in Appendix A. This should also be checked on the instrument label to ensure that the controller is suitable for the process to be controlled.

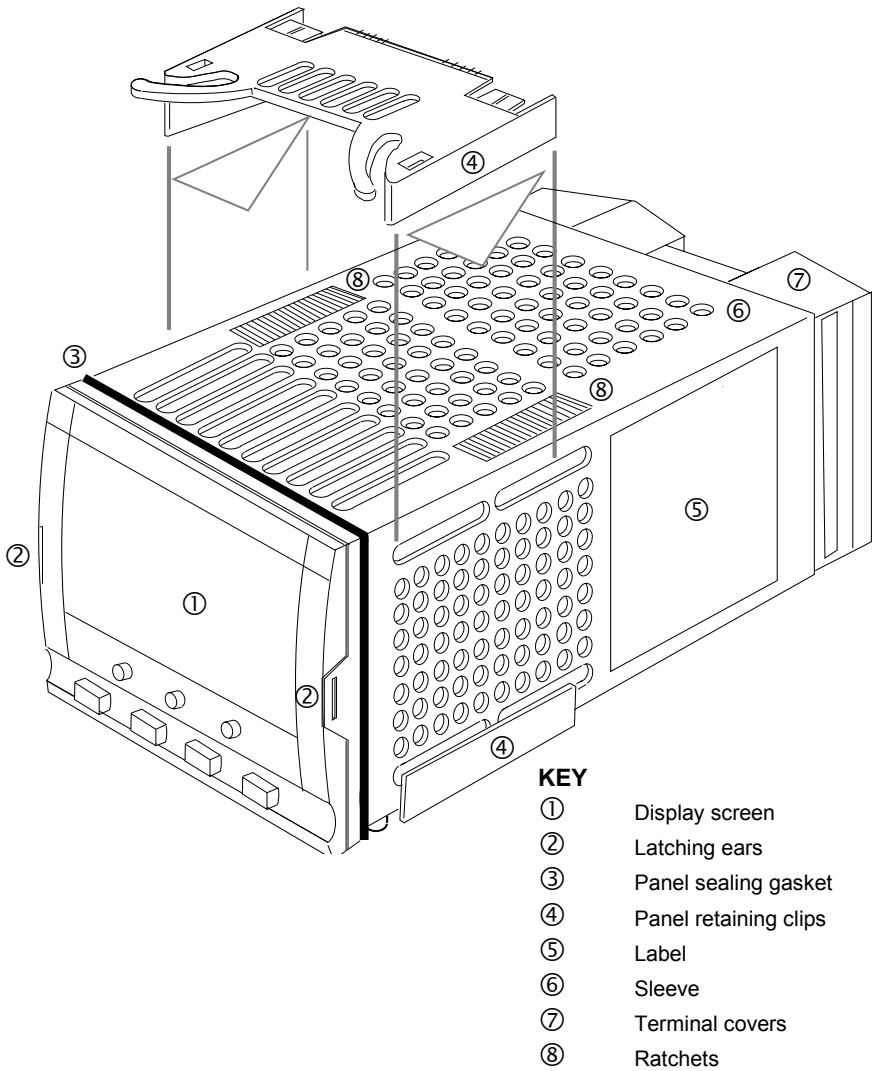

**Figure 1-2: General View of 2604 Controller**



### 1.3. OPERATOR INTERFACE - OVERVIEW

The front panel of the 2604 consists of two 5 digit numeric displays, one alpha numeric LCD panel for display of messages and other information, eight LED status indicators and seven operator push-buttons. See Figure 1-3 below.

- The display is used to show the process conditions.
- The seven operator buttons allow adjustments to be made to the controller.

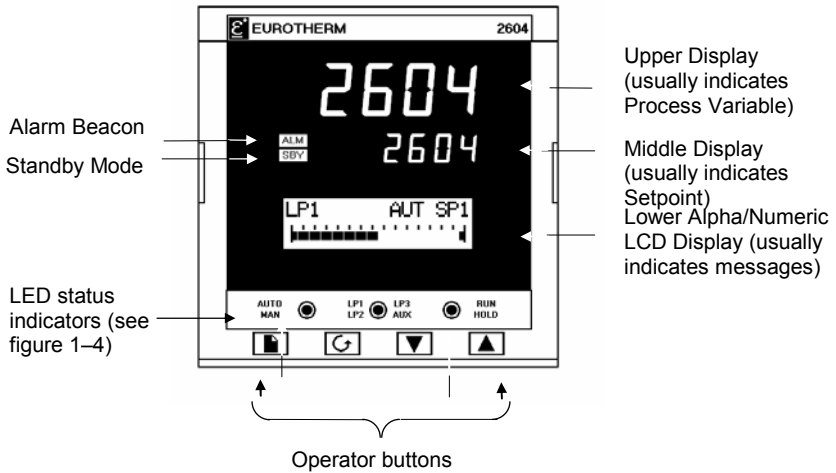

Figure 1-3: Operator Interface

### 1.3.1. LED Status Indicators



Indicator	Function
AUTO	The selected loop is in automatic (closed loop) control
MAN	The selected loop is in manual (open loop) control
LP1	Indicates which control loop is selected
LP2	
LP3	
AUX	Indicates that the selected loop has a second control function. For example, if a loop is configured as cascade, ratio or override then a second press of the loop button will cause the AUX indicator to illuminate together with the loop indicator.
RUN	Indicates a program is activated
HOLD	Indicates a program is held at its current levels
ALARM BEACON	This is a red LED which will flash when any new alarm occurs. It will be accompanied by a message displayed on the lower readout. The beacon will be permanently lit when an alarm is acknowledged but is still present. See Chapter 7 'Alarm Operation' for further details.
STANDBY BEACON	This is a green LED which will be lit when the controller is in Standby mode. When the controller is in standby mode all interfaces to the plant are switched to a rest condition. For example, all control outputs = 0.  <b>When this beacon is lit the controller is no longer controlling the process.</b>  This beacon will be lit when:- <ul style="list-style-type: none"> <li>• The controller is in configuration mode</li> <li>• Standby mode has been selected through the user interface or via an external digital input</li> <li>• During the first few seconds after start up</li> </ul>

**Table 1-1: Status Messages**

### 1.3.2. Operator Buttons

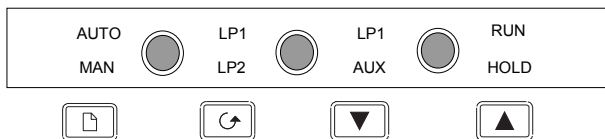







	<p>Auto/Manual button</p>	<p>The Auto/Manual button only operates from the loop view. When pressed, this toggles between automatic and manual mode:</p> <ul style="list-style-type: none"> <li>• If the controller is in automatic mode the AUTO light will be lit.</li> <li>• If the controller is in manual mode, the MAN light will be lit.</li> </ul> <p>The Auto/Manual button can be disabled in configuration level.</p>
	<p>Loop select button</p>	<p>Repeat pressing to select:-                  Loop1 ▶ Loop2 ▶ Loop 3 ▶ Back to Loop1</p> <p>If any one loop is cascade, ratio or override the AUX indicator will illuminate as well as the loop indicator</p>
	<p>Run/Hold button</p>	<ul style="list-style-type: none"> <li>• Press once to start a program (RUN light on.)</li> <li>• Press again to hold a program (HOLD light on)</li> <li>• Press again to cancel hold and continue running (HOLD light off and RUN light ON)</li> <li>• Press and hold in for two seconds to reset a program (RUN and HOLD lights off)</li> </ul> <p>The RUN light will flash at the end of a program.                  The HOLD light will flash during holdback.</p>
	<p>Page button</p>	<p>Press to select a new list of parameters.</p>
	<p>Scroll button</p>	<p>Press to select a new parameter in a list.</p>
	<p>Down button</p>	<p>Press to decrease a parameter value.</p>
	<p>Up button</p>	<p>Press to increase a parameter value.</p>

Figure 1-4: Operator Buttons

## 1.4. INSTALLATION - OVERVIEW

The 2604 controller must be mounted and wired in accordance with the instructions given in Chapter 2.

The controller is intended to be mounted through a cut out in the front panel of an electrical control cabinet. It is retained in position using the panel mounting clips supplied.

All wires are connected to terminals at the rear of the instrument. Each block of six terminals is protected by a hinged cover which clicks into closed position.

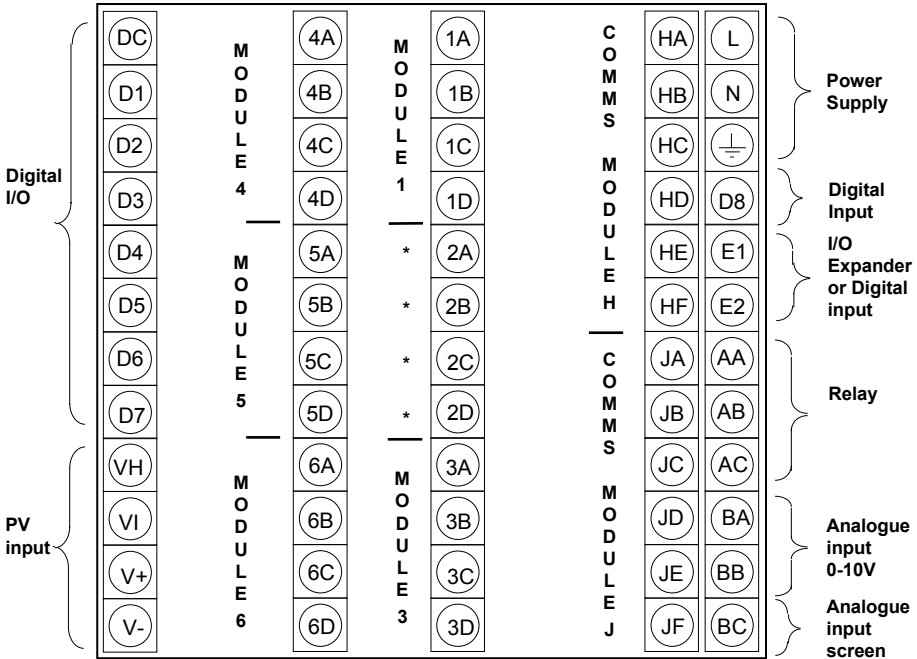

The functionality of the two outer rows of terminals is common to all instrument variants, as follows:-

PV input	VH, VI, V+, V-
Analogue input	BA, BB
I/O expander	E1, E2
Fixed changeover relay	AA, AB, AC
Digital I/O channels	D1 to D8 and DC
Power supply	L, N, Earth

\* Terminals 2A, 2B, 2C, 2D must not be wired to.

Figure 1-5: Rear Terminals

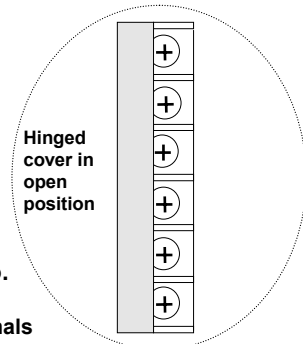

## 1.5. I/O MODULES

The 2604 controller has the facility to fit optional plug in modules. The connections for these modules are made to the inner three connector blocks as shown in Figure 1-6

The modules are:

- Communications modules See also section 2.4
- I/O modules See also section 2.4

These modules are fitted simply by sliding them into the relevant position as shown below.

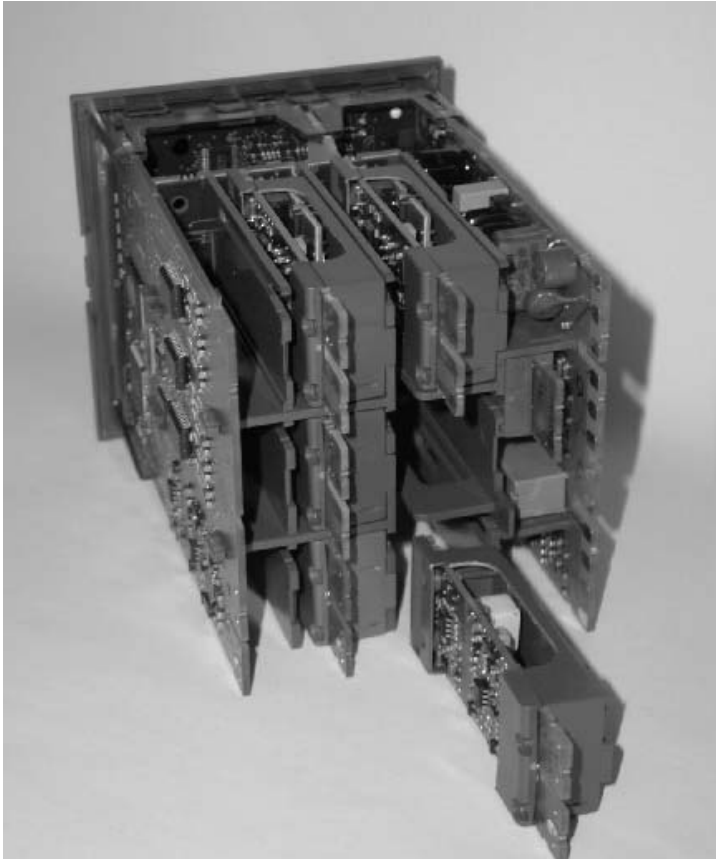

**Figure 1-6: View of the Plug-in Modules**



<b>2.</b>	<b>CHAPTER 2 INSTALLATION.....</b>	<b>2</b>
2.1.	<b>MECHANICAL INSTALLATION.....</b>	<b>2</b>
2.1.1.	Positioning.....	2
2.1.2.	Outline dimensions Model 2604.....	2
2.1.3.	Mounting the Controller.....	3
2.1.4.	Unplugging and Plugging in the Controller.....	3
2.2.	<b>WIRING.....</b>	<b>4</b>
2.2.1.	Electrical Connections.....	4
2.2.2.	Rear Terminal Layout.....	4
2.3.	<b>STANDARD CONNECTIONS.....</b>	<b>6</b>
2.3.1.	Power Supply Wiring.....	6
2.3.2.	Relay Output.....	7
2.3.3.	Sensor Input Connections.....	8
2.3.4.	Analogue Input Connections.....	9
2.3.5.	I/O Expander (or Additional Digital Input).....	10
2.3.6.	Digital I/O.....	11
2.4.	<b>OPTIONAL PLUG IN MODULE CONNECTIONS.....</b>	<b>12</b>
2.4.1.	Digital Communications Connections.....	12
2.4.2.	Devicenet Wiring.....	14
2.4.3.	Master/Slave Communications.....	16
2.4.4.	I/O Modules.....	18
2.5.	<b>TO CONNECT ZIRCONIA (DUAL SIGNAL) PROBE.....</b>	<b>24</b>
2.5.1.	Zirconia Probe Screening.....	25

## 2. Chapter 2 INSTALLATION

### 2.1. MECHANICAL INSTALLATION

#### 2.1.1. Positioning

The controller can be mounted vertically or on a sloping panel of maximum thickness 15mm (0.6in). Adequate access space must be available at the rear of the instrument panel for wiring and servicing purposes. The outline dimensions are shown in figure 2-1.

Take care not to cover ventilation holes in the top, bottom and sides of the instrument.

Before proceeding please read Appendix B ‘Safety and EMC Information’.

#### 2.1.2. Outline dimensions Model 2604

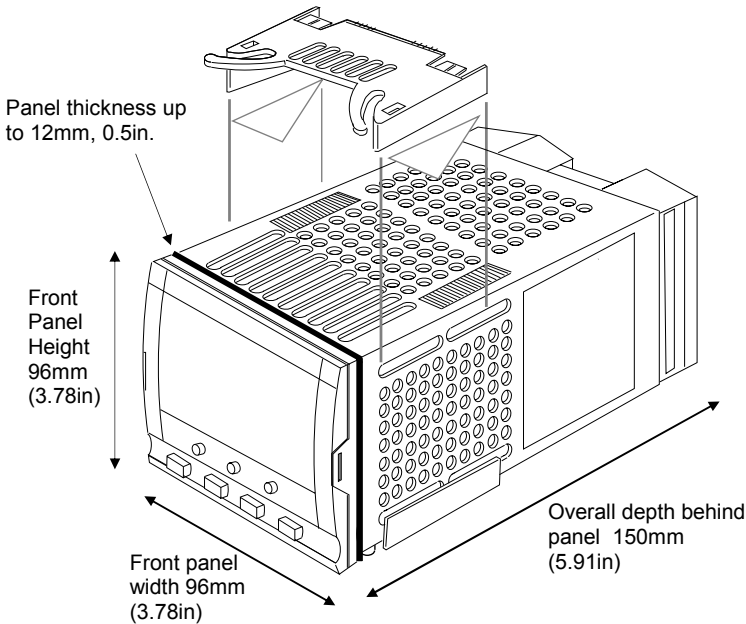

**Figure 2-1: Outline Dimensions**



### 2.1.3. Mounting the Controller

1. Prepare the panel cut-out to the size shown in Figure 2-2. Ensure that there is sufficient spacing between instruments as shown by the minimum dimensions given in Figure 2-2. Ensure also that the controller is not mounted close to any device which is likely to produce a significant amount of heat which may affect the performance of the controller.
2. Insert the controller through the panel cut-out.
3. Spring the upper and lower panel retaining clips into place. Secure the controller in position by holding it level and pushing both retaining clips forward.

Note:- If the retaining clips subsequently need removing, in order to extract the controller from the control panel, they can be unhooked from the side with either your fingers or a screwdriver.

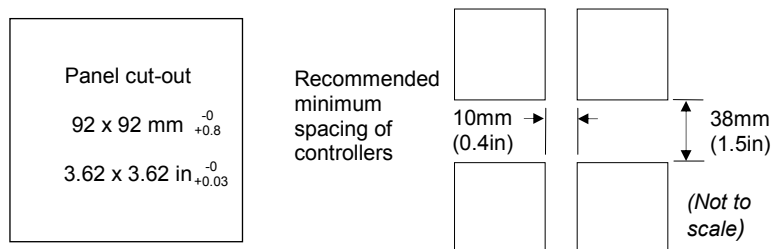

**Figure 2-2: Panel Cut-out and Minimum Spacing Requirements**

### 2.1.4. Unplugging and Plugging in the Controller

If required, the controller can be unplugged from its sleeve by easing the latching ears outwards and pulling the controller forward out of the sleeve. When plugging the controller back into its sleeve, ensure that the latching ears click into place.

It is recommended that the power to the controller is switched off when un-plugging or plugging the controller into its sleeve. This is to prevent premature wear on the controller connectors when current is flowing through them.

## 2.2. WIRING

### WARNING



**You must ensure that the controller is correctly configured for your application. Incorrect configuration could result in damage to the process being controlled, and/or personal injury. It is your responsibility, as the installer, to ensure that the configuration is correct. The controller may either have been configured when ordered, or may need configuring now. See 2604 Engineering Manual Part Number HA026761 for details.**

**Before proceeding further, please read Appendix B, Safety and EMC information.**

### 2.2.1. Electrical Connections

All electrical connections are made to the screw terminals at the rear of the controller. They accept wire sizes from 0.5 to 1.5 mm<sup>2</sup> (16 to 22 AWG) and should be tightened to a torque of 0.4Nm (3.5lbin). If you wish to use crimp connectors, the correct size is AMP part number 349262-1. The terminals are protected by a clear plastic hinged cover to prevent hands, or metal, making accidental contact with live wires.

### 2.2.2. Rear Terminal Layout

The rear terminal layout is shown in Figure 2-3, which identifies terminal designations and their functions. Refer to the individual diagrams to wire the controller to your requirements.

The two outer terminal strips have fixed hardware for all versions of the instrument, as follows:-

- A Process Variable input which can be configured for:-
  - Thermocouple, RTD, Pyrometer, Voltage (e.g. 0-10Vdc) or Milliamp (e.g. 4-20mA) plus vacuum – log10
- Seven Digital I/O, configurable as input or output
  - Inputs are logic (-1 to 35Vdc) or contact closure, and can be configured for:- Manual, Remote, Run, Hold, Reset, etc,
  - Outputs are open collector requiring an external power supply, and can be configured as event, status time proportioning or valve position outputs.
- One digital input
- An I/O expander which allows additional digital I/O via an external unit, or an extra digital input
- A changeover relay which can be configured as an alarm or event output. It cannot be configured as a time proportioning output
- An analogue input for volts (e.g. 0-10Vdc) or Milliamp (e.g. 4-20mA) signals to a second PID loop, setpoint, etc,. (This input can be characterised to match a particular curve from a transmitter. It cannot accept thermocouple inputs directly)
- Power supply to the unit. The supply may be 85 - 264Vac 50 or 60 Hz,

The three central terminal strips are for optional plug in modules, as follows:-

- Terminals marked 2A to 2D are reserved for a Memory Module only. No connections should be made to these terminals
- Terminals marked HA to HF are connections for optional RS232, RS485, or RS422 communications modules
- Terminals marked JA to JF are connections for an optional slave communications module or second communications port used to communicate with other instruments  
The modules fitted into the above two communications slots can be inter-changed

For a full list of available modules refer to the Ordering code - Appendix A and the Technical Specification - Appendix C.



**Warning:- Take care that mains supplies are connected only to the power supply terminals (85 to 254Vac only), the fixed relay terminals or to relay or triac modules. Under no circumstances should mains supplies be connected to any other terminals.**

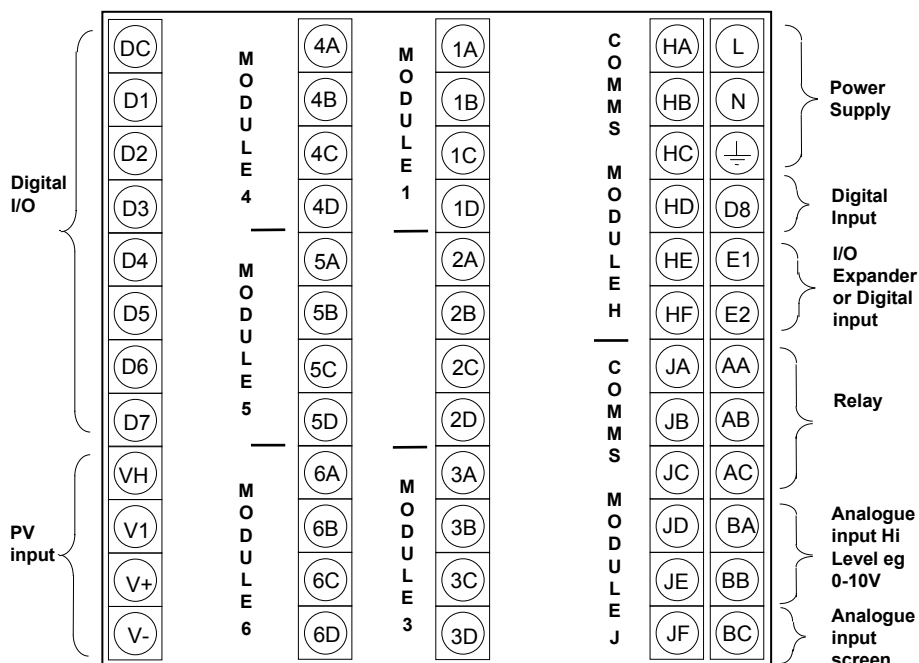

Figure 2-3: Rear Terminal Connections

## 2.3. STANDARD CONNECTIONS

### 2.3.1. Power Supply Wiring

Controllers supplied with the VH Supply Voltage option are suitable for connection to a power supply of between 85 and 264Vac 50 or 60 Hz.

Controllers supplied with the VL Supply Voltage option are suitable for connection to a power supply of between 20 and 29Vac 50 or 60 Hz or 20 to 29Vdc. Polarity not important.

Notes:

1. Make sure the voltage corresponds to the description on the identification label
2. It is the user's responsibility to provide an external fuse or circuit breaker. Suitable fuses are :
 

-85 to 264 volt supply	T type (EN60127 time-lag type) rated at 1A
20 to 29 volt supply	T type (EN60127 time-lag type) rated at 4A
3. Use copper conductors only
4. To avoid electric shock, connect the power line at the end of the wiring procedure
5. Do not run power cables with signal wires such as input, output or digital communications
6. The safety requirements for Permanently Connected Equipment say:
  - A switch or circuit breaker shall be included in the building installation
  - it shall be in close proximity to the equipment and within easy reach of the operator
  - it shall be marked as the disconnecting device for the equipment
  - a single switch or circuit breaker can drive more than one instrument

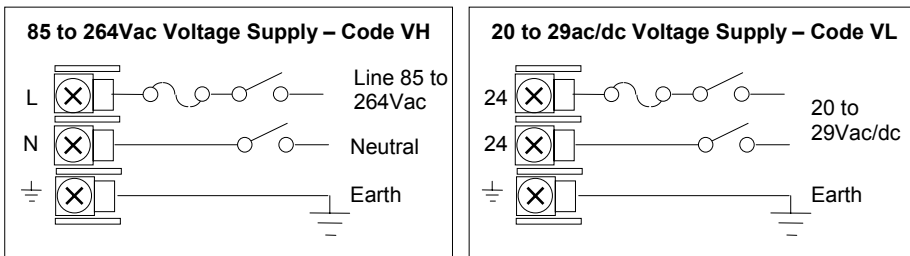

Figure 2-4: Supply Voltage Connections

### 2.3.2. Relay Output

A single changeover relay is provided as standard. It can be configured as a control output or an alarm or event output.

Notes:

1. To avoid electric shock, connect the power line at the end of the wiring procedure
2. Use copper conductors only
3. Do not run power wires with input or digital communications wiring

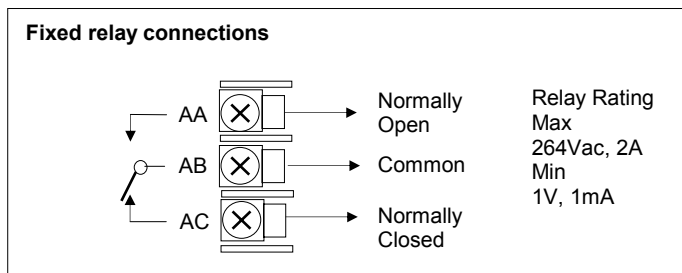

**Figure 2-5: Wiring Connections For Fixed Relay Output**

### 2.3.3. Sensor Input Connections

The fixed PV input can accept a range of sensors including Thermocouple, RTD (Pt100), Pyrometer, Voltage (e.g. 0-10Vdc) or Milliamp (e.g. 4-20mA) signals. These sensors are used to provide inputs to Control Loop 1.

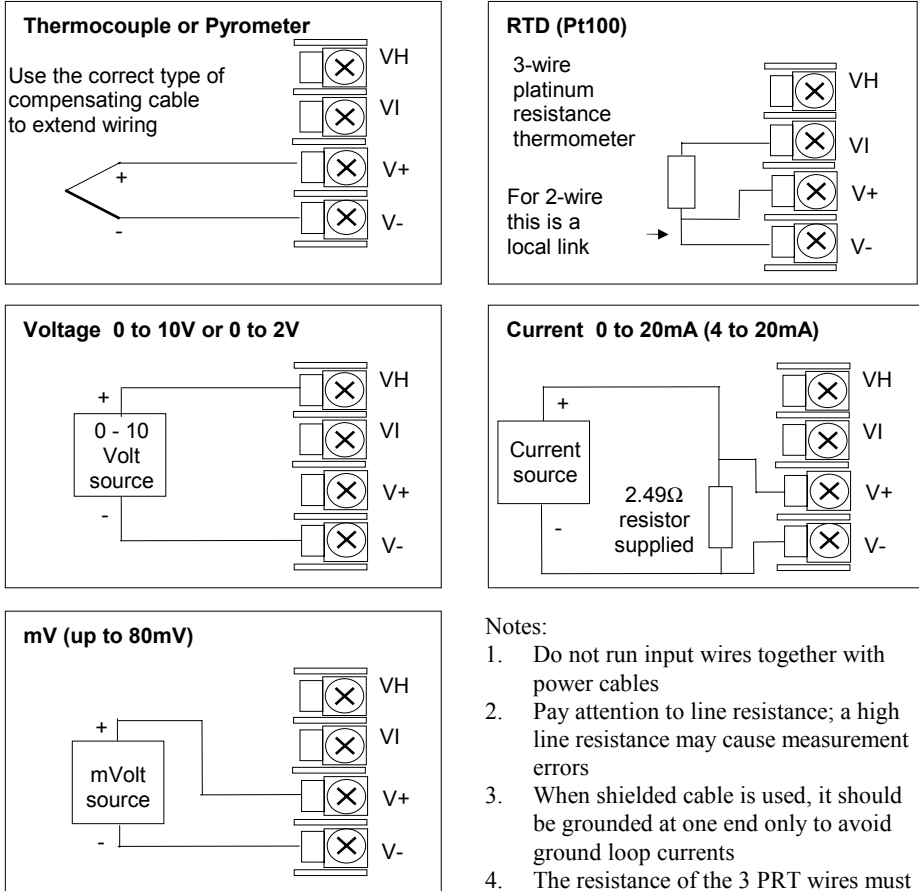

- Notes:
1. Do not run input wires together with power cables
  2. Pay attention to line resistance; a high line resistance may cause measurement errors
  3. When shielded cable is used, it should be grounded at one end only to avoid ground loop currents
  4. The resistance of the 3 PRT wires must be the same
  5. For TC wiring use the appropriate compensating cable

**Figure 2-6: Wiring Connections For PV Input**

### 2.3.4. Analogue Input Connections

The analogue input is supplied as standard and is intended to accept 0 to 10 Vdc from a voltage source. A milli-amp current source can be used by connecting a  $100\Omega$  resistor across terminals BA and BB. This input can be used as a remote setpoint input, remote setpoint trim or as a high level PV input to a control loop. This input is not isolated from the digital IO.

#### Non-isolated Voltage Source (0 to 10V)

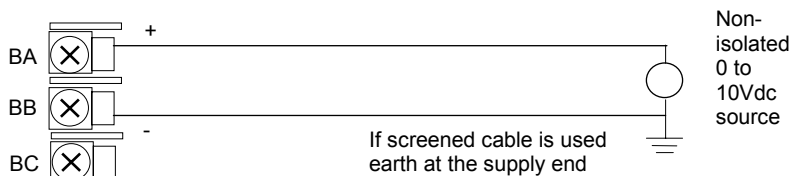

#### Non-isolated Current Source (0 - 20mA) (4 - 20mA)

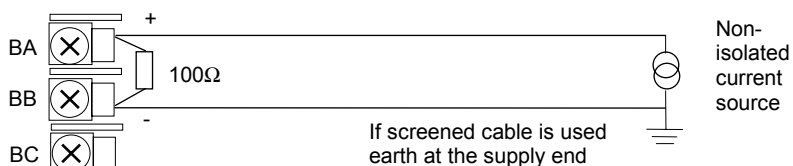

#### Isolated Voltage Source (0 to 10V)

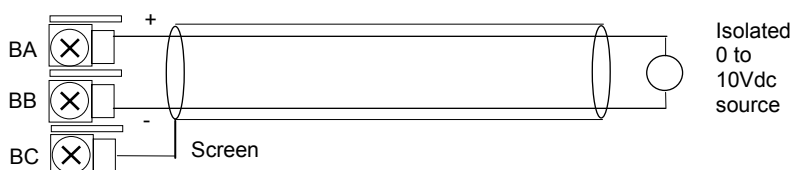

#### Isolated Current Source (0 - 20mA) (4 - 20mA)

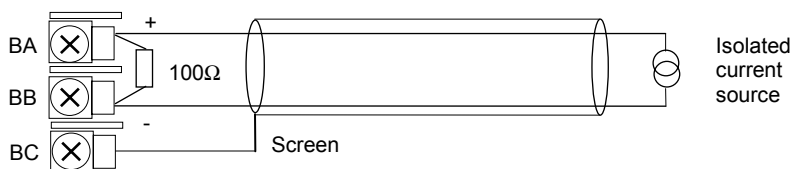

Figure 2-7: Wiring Connections For Analogue Input

### 2.3.5. I/O Expander (or Additional Digital Input)

An I/O expander (Model No 2000IO) can be used with the 2604 to allow the number of I/O points to be increased by a further 20 digital inputs and 20 digital outputs. Data transfer is performed serially via a two wire interface from instrument to expander.

If the expander unit is not required it is possible to use terminals E1 & E2 as a secondary digital input. These terminals are not part of the digital I/O terminals D1 to D8 and if used in this way connect a 2K2, ¼ W limiting resistor in series with the input, see Figure 2-8.

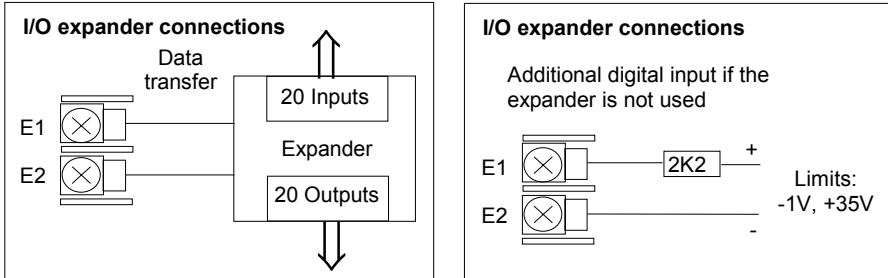

Figure 2-8: Wiring Connections for the I/O Expander

For details of the IO Expander refer to the Operating Instructions HA026893. The connections for this unit are reproduced below for convenience.

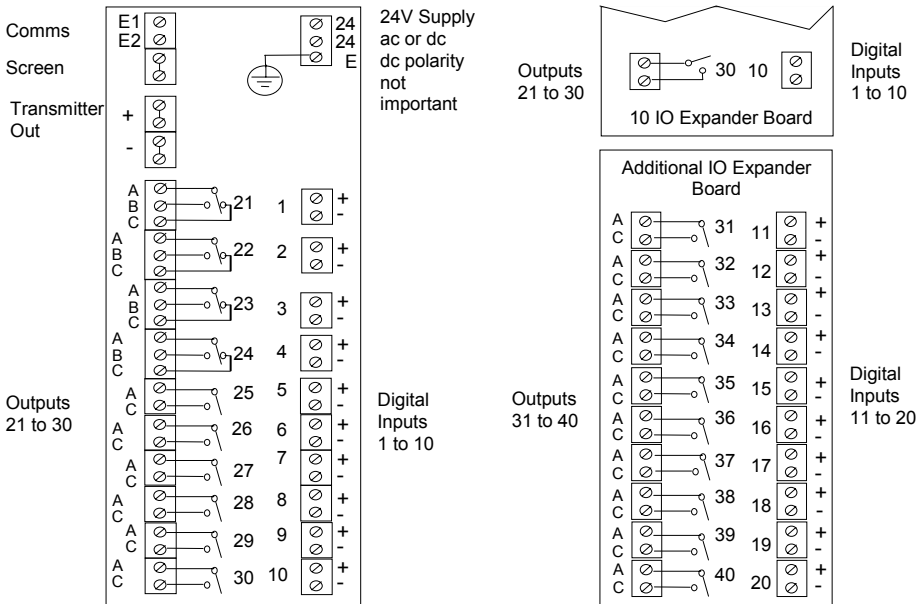

Figure 2-9: IO Expander Connections



### 2.3.6. Digital I/O

Eight digital I/O connections are provided as standard. They can be individually configured as:

1. Inputs                      Run, Hold, Reset, Auto/Manual, etc. - logic or contact closure.
2. Outputs                    Configurable as Control outputs, Programmer Events, Alarms, etc.

Digital IO is not isolated from instrument ground.

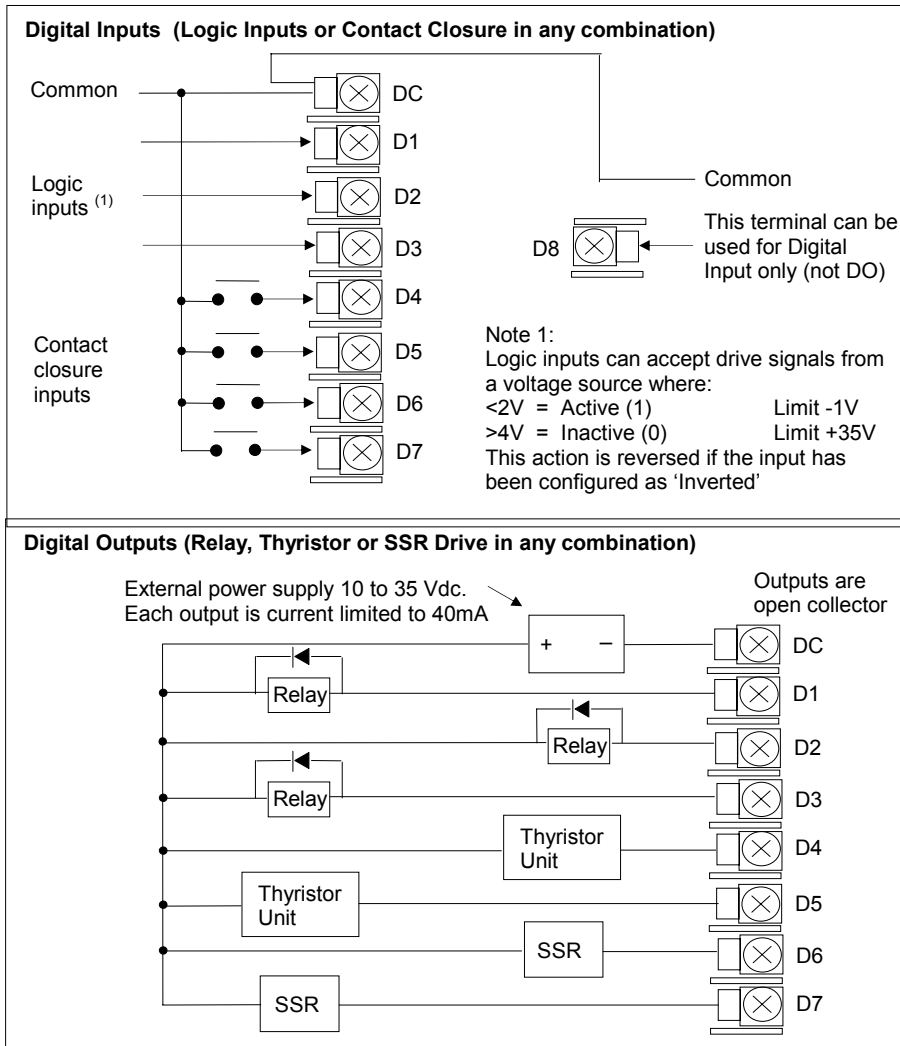

Figure 2-10: Wiring Connections for Digital I/O

## 2.4. OPTIONAL PLUG IN MODULE CONNECTIONS

### 2.4.1. Digital Communications Connections

Digital Communications modules can be fitted in two positions in the 2604 controller. The connections are available on HA to HF or JA to JF depending on the position in which the module is fitted. The two positions could be used, for example, to communicate with a configuration package, such as 'iTools' on one position and to a PC running a supervisory package on the second position OR with master/slave communications.

The connections shown in the following diagrams show RS232, 2-wire RS485, 4-wire RS422 and master/slave comms to a second controller.

Do not run digital communications wiring with power cables. The following diagrams show connections for 'bench top test' wiring. For a full description of the installation of a communications link, including line resistors, see Communications Handbook, Part No. HA026230, and EMC Installation Guide, part no. HA025464.

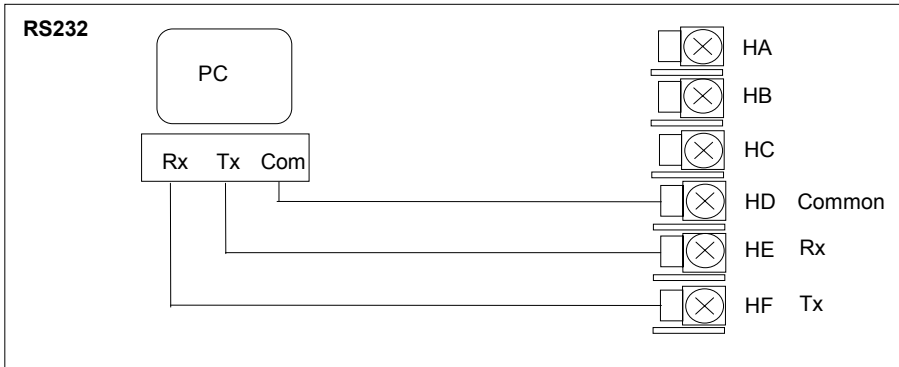

Figure 2-11: RS232 Communications Connections

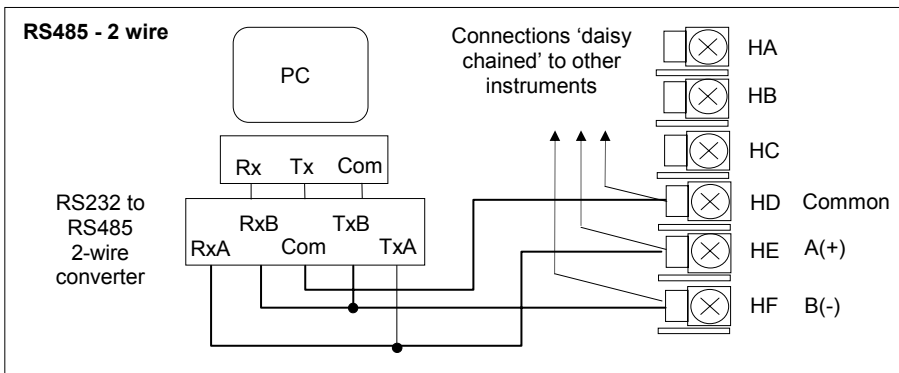
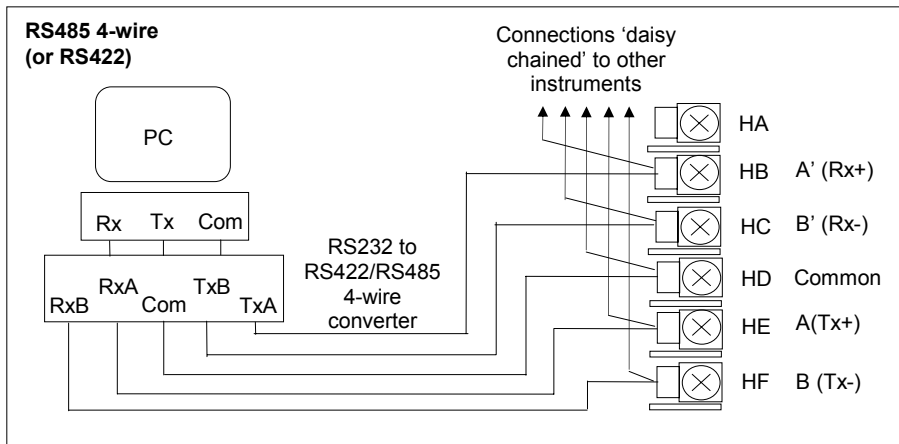
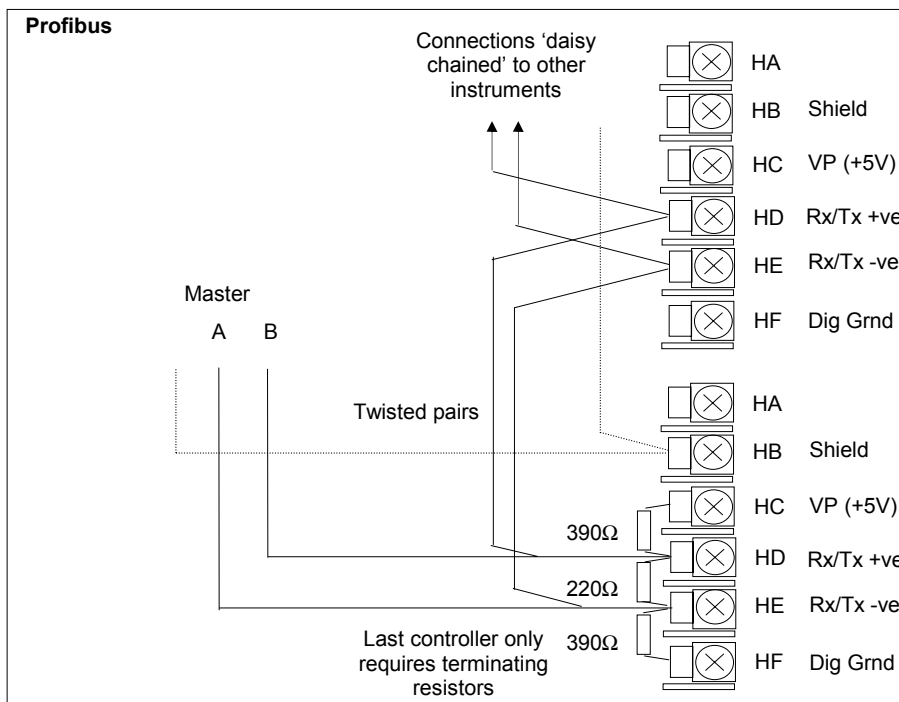

Figure 2-12: RS485 2-Wire Communications Connections



**Figure 2-13: RS485 4-Wire Communications Connections**



**Figure 2-14: Profibus Wiring Connections**

## 2.4.2. Devicenet Wiring

This section covers the DeviceNet digital communications option. To configure DeviceNet communications refer to the 2604 Engineering Handbook Part No HA026761.

### 2.4.2.1. DeviceNet Terminal Functions

Terminal Reference	CAN Label	Color Chip	Description
HA	V+	Red	DeviceNet network power positive terminal. Connect the red wire of the DeviceNet cable here. If the DeviceNet network does not supply the power, connect to the positive terminal of an external 11-25 Vdc power supply.
HB	CAN_H	White	DeviceNet CAN_H data bus terminal. Connect the white wire of the DeviceNet cable here.
HC	SHIELD	None	Shield/Drain wire connection. Connect the DeviceNet cable shield here. To prevent ground loops, the DeviceNet network should be grounded in only one location.
HD	CAN_L	Blue	DeviceNet CAN_L data bus terminal. Connect the blue wire of the DeviceNet cable here.
HE	V-	Black	DeviceNet network power negative terminal. Connect the black wire of the DeviceNet cable here. If the DeviceNet network does not supply the power, connect to the negative terminal of an external 11-25 Vdc power supply.
HF			Connect to instrument earth

Note: Power taps are recommended to connect the DC power supply to the DeviceNet trunk line. Power taps include:



A Schottky Diode to connect the power supply V+ and allows for multiple power supplies to be connected.

2 fuses or circuit breakers to protect the bus from excessive current which could damage the cable and connectors.

The earth connection, HF, to be connected to the main supply earth terminal.

**2.4.2.2. Wiring Interconnections for DeviceNet Communications**

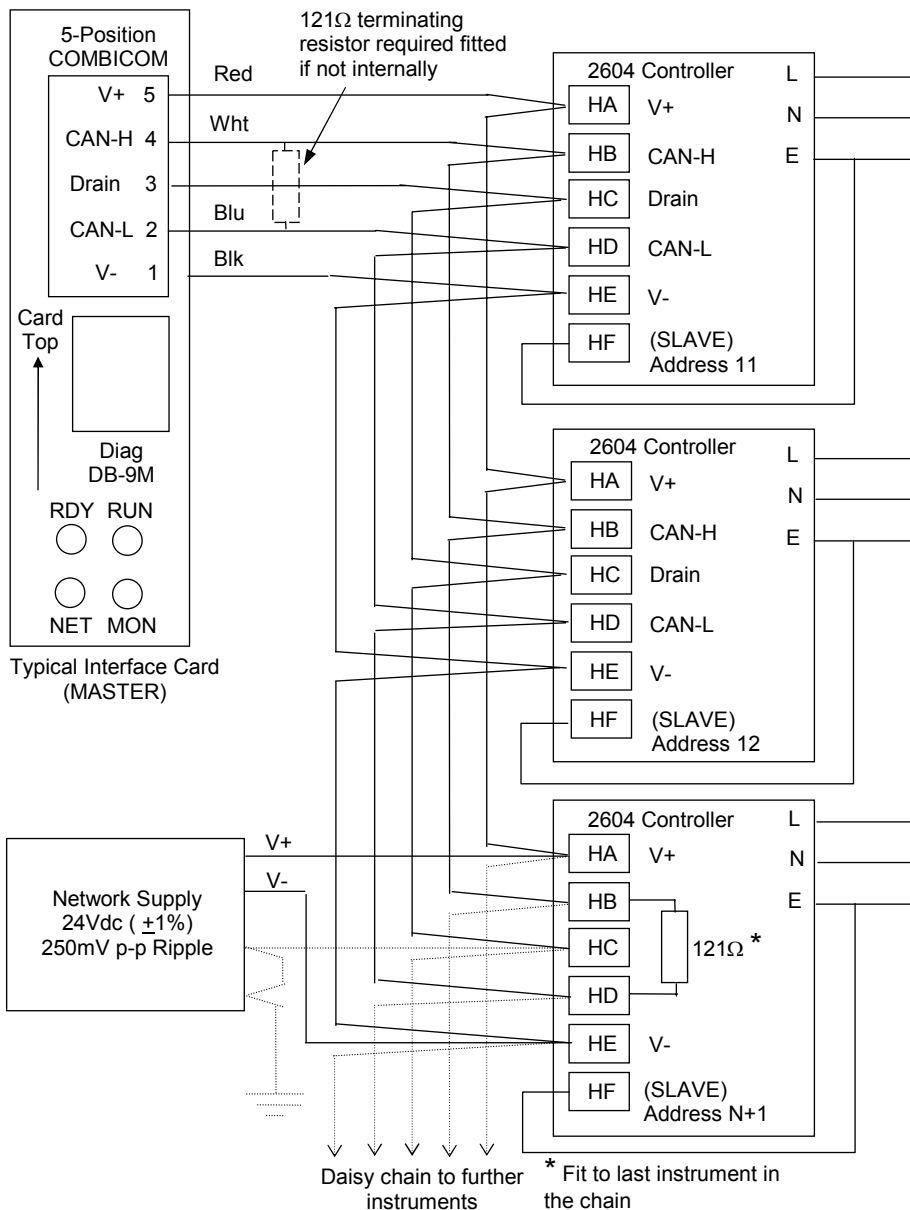

### 2.4.3. Master/Slave Communications

The following diagrams show connections for a range of different controllers using RS422. These are representative of typical slaves which may be used but could also include third party products using Modbus protocol.

#### RS422 or RS485 4-wire

Slave Terminal Numbers for Different Instruments						
Terminal Function	2600 2700	2200 2400	94C	900 EPC	818/5	902/3 /4
Tx+	HE or JE	HE	11	X1	15	F1
Tx-	HF or JF	HF	12	X2	16	F2
Rx+	HB or JB	HB	13	X3	13	F3
Rx-	HC or JC	HC	14	X4	14	F4
Com	HD or JD	HD	15	X5	17	F5

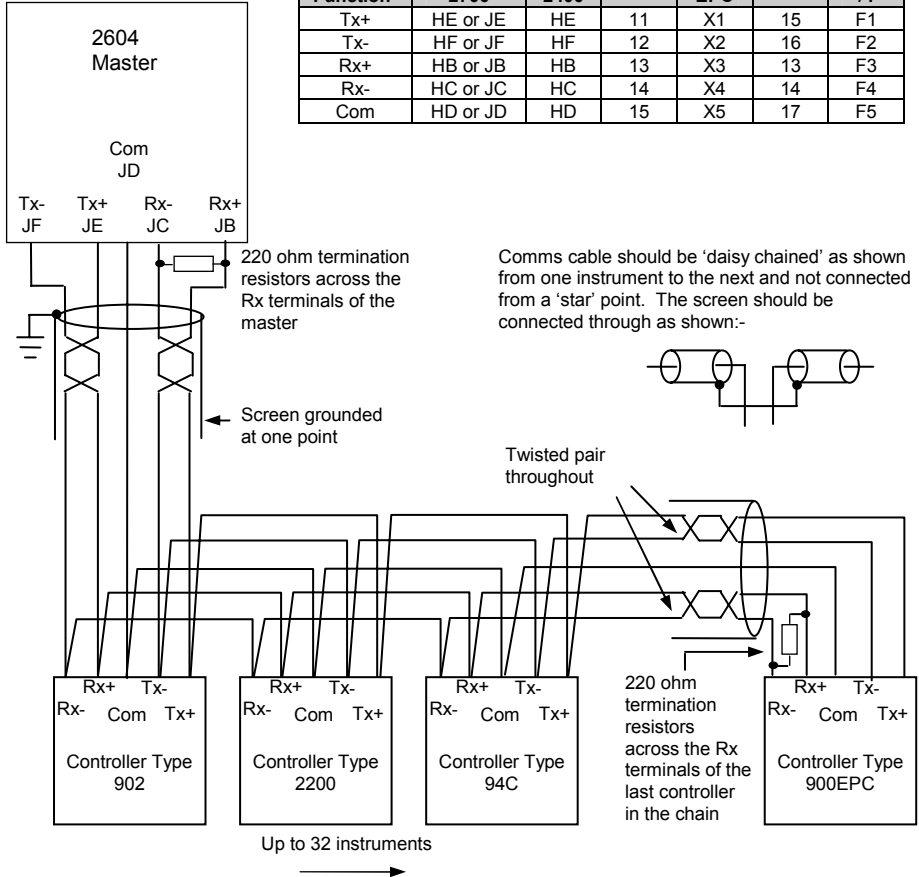
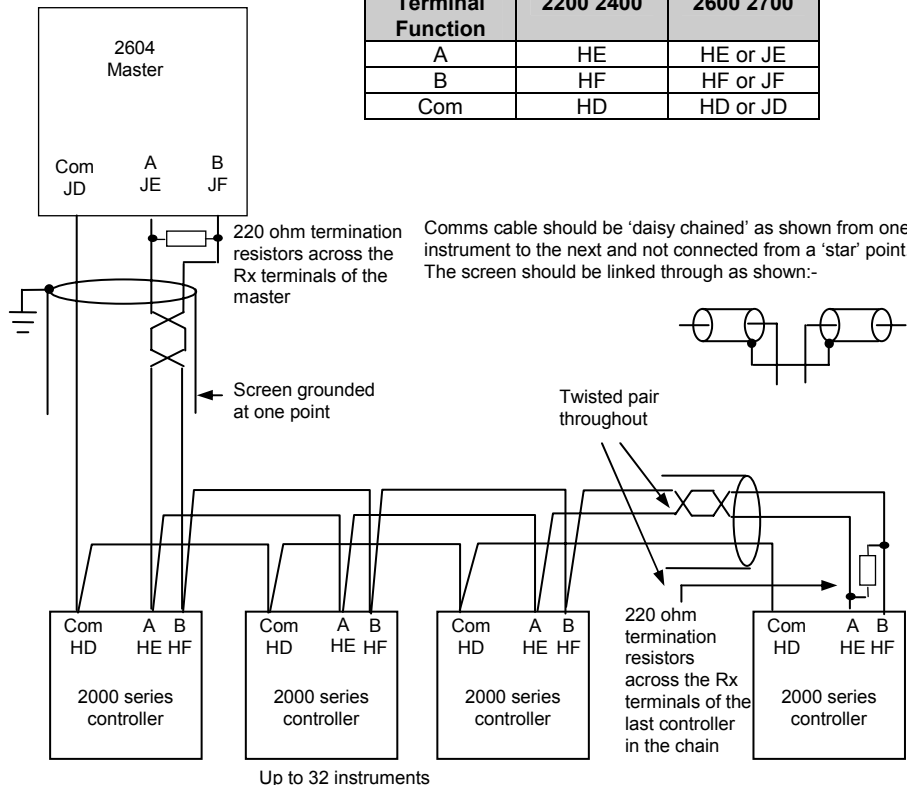

Figure 2-15: Example Wiring RS422 or RS485 4-wire for Different Slaves

### RS485 2-wire

Slave Terminal Numbers		
Terminal Function	2200 2400	2600 2700
A	HE	HE or JE
B	HF	HF or JF
Com	HD	HD or JD



**Figure 2-16: Example Wiring RS485 2-wire for 2000 Series Instruments**

### RS232

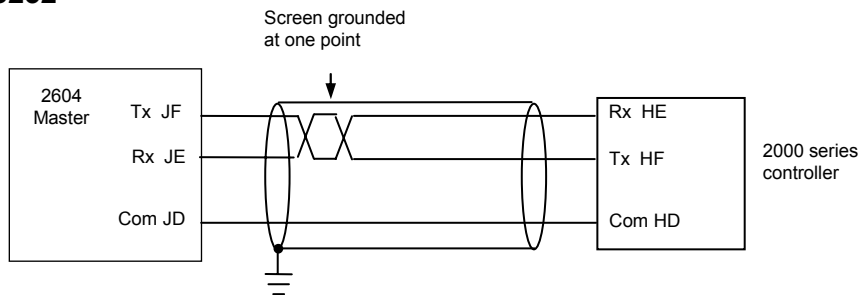

**Figure 2-17: Example Wiring RS232 for 2000 Series Instruments**

### 2.4.4. I/O Modules

The 2604 controller contains five positions in which 4-terminal I/O modules can be fitted. These positions are marked Module 1, Module 3, Module 4, Module 5, Module 6, in Figure 2-3. Module 2 is reserved for the Memory Module which can only be fitted in this position. To find out which modules are fitted check the ordering code which is found on a label on the side of the instrument.

Any module, listed in this section, can be fitted in any position, except the PV input - limited to positions 3 and 6 only; and the Analogue Input module - cannot be fitted in slot 5. Care should be taken, therefore, to ensure that modules are fitted as expected from the order code. The instrument can be interrogated in 'View Config' level to locate the positions in which the modules are fitted. See Chapter 4, Access Levels. If modules have been added, removed or changed it is recommended that this is recorded on the instrument code label.







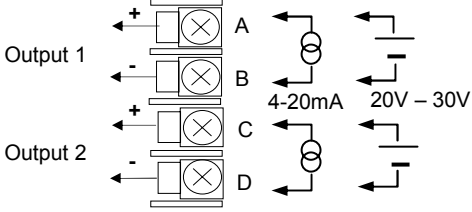
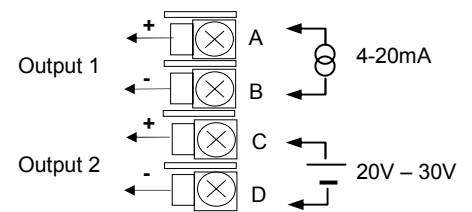

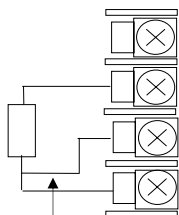
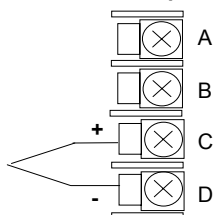
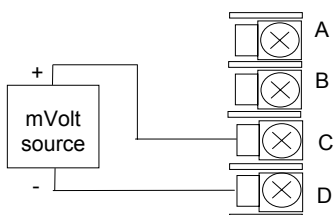
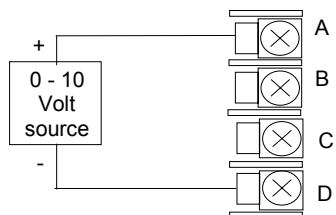
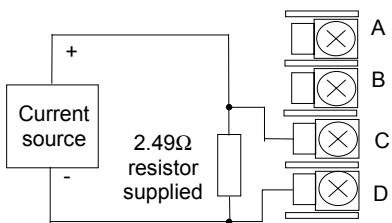



I/O Module	Typical usage	H/W Code	Connections and examples of use
<p>Note: The order code and terminal number is pre-fixed by the module number.                      Module 1 is connected to terminals 1A, 1B, 1C, 1D; module 3 to 3A, 3B, 3C, 3D, etc.</p>			
<p><b>Relay (2 pin) and Dual Relay</b>                      max                      264Vac, 2A,                      min                      12V, 100mA</p>	<p>Heating, cooling, alarm, program event, valve raise, valve lower</p>	<p>R2 and RR</p>	
<p><b>Change Over Relay</b>                      max                      264Vac, 2A,                      min                      12V, 10mA</p>	<p>Heating, cooling, alarm, program event, valve raise, valve lower</p>	<p>R4</p>	
<p><b>Isolated Single Logic Output</b>                      18Vdc at                      24mA max</p>	<p>Heating, Cooling, Program events</p>	<p>LO</p>	



I/O Module	Typical usage	H/W Code	Connections and examples of use
<p><b>Triple Logic Output</b></p> <p>(18Vdc at 8mA max. per channel)</p>	<p>Heating, cooling, program events</p>	<p>TP</p>	
<p><b>Triac and Dual Triac</b></p> <p>(0.7A, 30 to 264Vac combined rating)</p>	<p>Heating, cooling, valve raise, valve lower</p>	<p>T2 and TT</p>	<p>Note: Dual relay modules may be used in place of dual triac.</p> <p><b>Note:-</b>  <b>The combined current rating for the two triacs must not exceed 0.7A.</b></p>
<p><b>DC Control</b></p> <p>(10Vdc, 20mA max)</p>	<p>Heating, cooling</p> <p>e.g. to a 4-20mA process actuator</p>	<p>D4</p>	
<p><b>DC Re-transmission</b></p> <p>(10Vdc, 20mA max)</p>	<p>Logging of PV, SP, output power, etc.,</p> <p>(0 to 10Vdc, or 0 to 20mA)</p>	<p>D6</p>	

I/O Module	Typical usage	H/W Code	Connections and examples of use
<p><b>Dual DC Output</b></p> <p>(each channel can be 4-20mA or 24Vdc power supply)</p>	<p>Control output 12 bit resolution</p> <p>Can only be fitted in slots 1,4 or 5</p>	<p>DO</p>	
<p><b>High Resolution DC Output</b></p> <p>(one 15 bit 4-20mA plus one 24V power supply)</p>	<p>Retransmission in 'feedback mode'</p> <p>Can only be fitted in slots 1,4 or 5</p>	<p>HR</p>	

I/O Module	Typical usage	Order Code	Connections and examples of use
<p><b>PV Input</b> (Modules 3 &amp; 6 only)</p> <p>and</p> <p><b>Analogue Input</b> (Modules 1, 3, 4 &amp; 6 only)</p>	<p>Second or third PV input</p> <p>mV, V, mA, TC, RTD (Pt100) Zirconia probe</p> <p>Second or third PV input</p> <p>mV, mA, TC, RTD (Pt100)</p>	<p>PV</p> <p>AM</p>	<div style="display: flex; justify-content: space-around;"> <div style="text-align: center;"> <p><b>3-wire RTD</b></p>  </div> <div style="text-align: center;"> <p><b>Thermocouple</b></p>  </div> </div> <p>For 2-wire this is a local link</p> <p><b>AM (up to 100mV)</b></p>  <p><b>Voltage 0 to 10V or 0 to 2V</b></p>  <p><b>Current 0 to 20mA (4 to 20mA)</b></p> 

I/O Module	Typical usage	Order Code	Connections and examples of use
<p><b>Triple Logic Input</b></p>	<p>Events e.g. Program Run, Reset, Hold</p>	<p>TL</p>	<p>Logic inputs</p> <p>Input 1 →  A</p> <p>Input 2 →  B</p> <p>Input 3 →  C</p> <p>Common →  D</p> <p>&lt;5V OFF &gt;10.8V ON Limits: -3V, +30V</p>
<p><b>Triple Contact Input</b></p>	<p>Events e.g. Program Run, Reset, Hold</p>	<p>TK</p>	<p>External Switches or Relays</p> <p>Input 1 →  A</p> <p>Input 2 →  B</p> <p>Input 3 →  C</p> <p>Common →  D</p> <p>Contact inputs &lt;100Ω ON &gt;28KΩ OFF</p>
<p><b>24V Transmitter Supply</b>  (20mA)</p>	<p>To power an external transmitter</p>	<p>MS</p>	<p>Transmitter</p> <p>+ →  A</p> <p>- →  B</p> <p> C</p> <p> D</p>

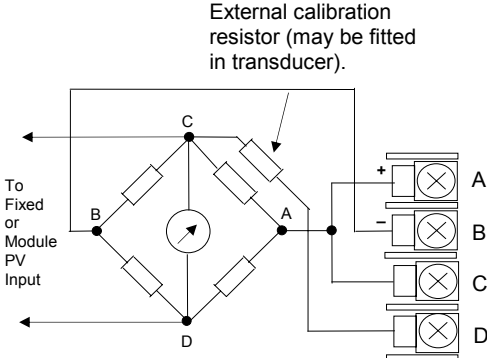
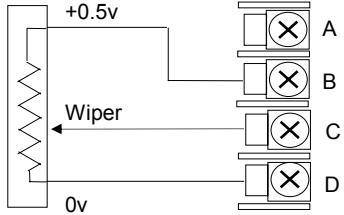
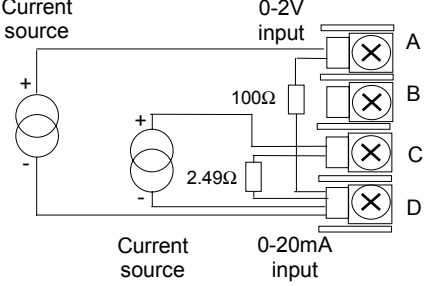
<p><b>Transducer Power Supply</b></p>	<p>Provide 5V or 10Vdc to power Strain Gauge Transducer + Shunt Contact</p>	<p>G3 or G5</p>	<p>External calibration resistor (may be fitted in transducer).</p>  <p>Note: To minimise noise pick up it is recommended that screened cables are used for strain gauge power supply connections.</p>
<p><b>Potentiometer Input</b>  (100Ω to 15KΩ)</p>	<p>Motorised valve position feedback  Remote SP</p>	<p>VU</p>	
<p><b>Dual PV Input</b> (Modules 3 &amp; 6 only)</p>	<p>To accept two inputs from a high level and a low level source. The two inputs are not isolated from each other.</p>	<p>DP</p>	 <p>The common connections to terminal D must be returned separately to D as shown in the dual current example above.</p>

**Figure 2-18: Wiring Connections for IO Modules**

## 2.5. TO CONNECT ZIRCONIA (DUAL SIGNAL) PROBE

A dual signal probe, such as a Zirconia probe, will normally be connected to a Dual PV Input module (Code DP). The module presents two channels, A and C, where A is the voltage input and C is the mV, thermocouple, RTD or mA input.

Example 1 shown below uses the Dual PV Input module with both channels configured. In this configuration the module runs at 4.5Hz. The two channels are un-isolated from one-another but isolated from the rest of the instrument.

Example 2 uses two modules. The modules can either be two PV Input modules (code PV) or a Dual PV Input module (code DP) with Channel C configured as 'None' plus a PV Input module. This combination runs at 9Hz and may be used if the loop is unusually fast.

I/O Module	Typical usage	Order Code	Connections and examples of use
Dual PV Input	Zirconia probe	DP	<p><b>Example 1:- Using the Dual PV Input Module.</b>                      Channel C is shown configured for thermocouple. The temperature sensor of a zirconia probe is connected to this input, terminals C &amp; D. The Volt Source is connected to the A channel, terminals A &amp; D.</p>  <p><b>Note:</b> The +ve of the volt source must be connected to the -ve of the thermocouple.</p>
Two PV Input Modules	PV		<p><b>Example 2:- Using Two Modules</b>                      The temperature sensor of the zirconia probe can be connected to the precision PV input of one I/O module, connections C &amp; D, with the Volt Source connected to the second module, terminals A &amp; D.</p> 

Figure 2-19: Wiring Connections for Zirconia Probe

## 2.5.1. Zirconia Probe Screening

### 2.5.1.1. Zirconia Carbon Probe Construction

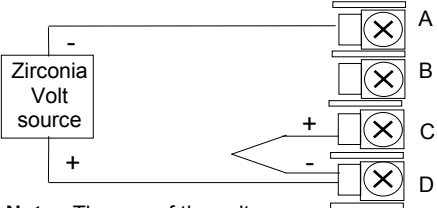
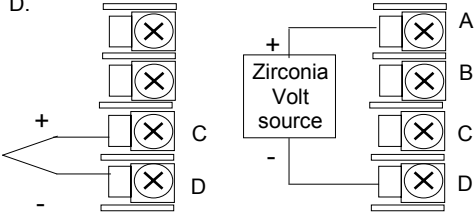
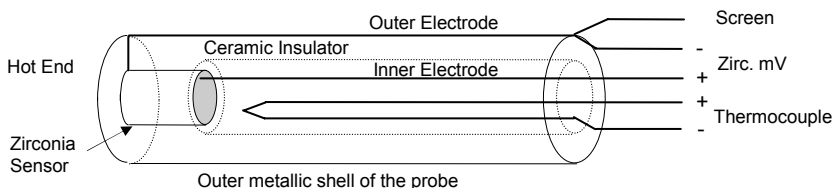

### 2.5.1.2. Screening connections when two modules are used

The zirconia sensor wires should be screened and connected to the outer shell of the probe if it is situated in an area of high interference.

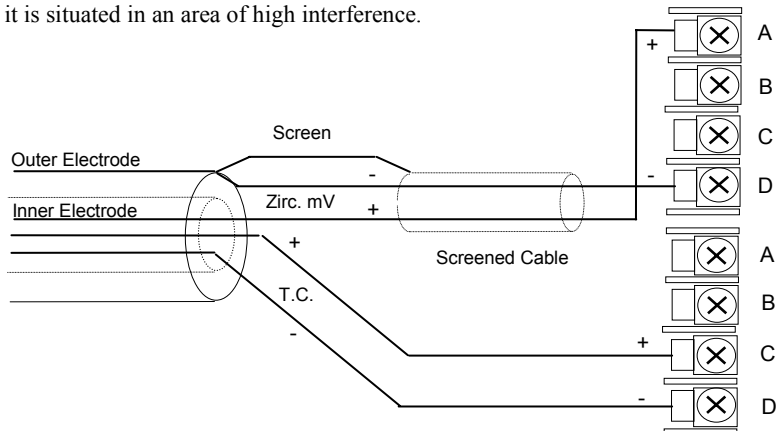

### 2.5.1.3. Screening connections when a dual input module is used

Both the thermocouple and the zirconia sensor wires must be screened and connected to the outer shell of the probe if it is situated in an area of high interference.

**Note the reverse connection of the zirconia sensor .**

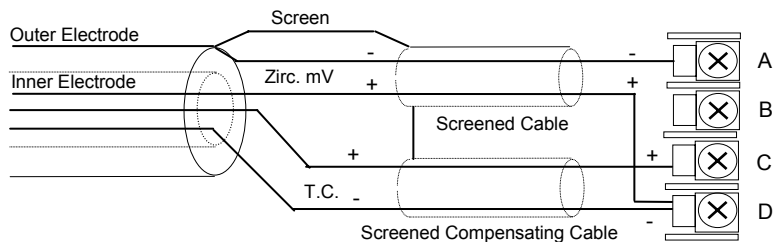





<b>3.</b>	<b>CHAPTER 3 PRINCIPLE OF OPERATION .....</b>	<b>2</b>
3.1.	<b>POWER UP.....</b>	<b>3</b>
3.1.1.	The HOME Page .....	3
3.2.	<b>THE OPERATOR BUTTONS.....</b>	<b>4</b>
3.3.	<b>THE AUTO MANUAL BUTTON.....</b>	<b>5</b>
3.4.	<b>THE RUN/HOLD BUTTON.....</b>	<b>5</b>
3.5.	<b>THE LOOP SELECT BUTTON</b> 	<b>6</b>
3.5.1.	To Change Setpoint (when the loop is in Auto).....	7
3.5.2.	To Change Output Power (when the loop is in Manual).....	7
3.6.	<b>PARAMETERS AND HOW TO ACCESS THEM .....</b>	<b>8</b>
3.6.1.	Pages.....	8
3.6.2.	To Step Through Page Headers .....	9
3.6.3.	Sub-headers .....	9
3.6.4.	To Step Through Parameters .....	10
3.6.5.	To Change Parameter Values .....	11
3.6.6.	Parameter Tables .....	13
3.7.	<b>SPECIFIC DISPLAYS FOR CASCADE, RATIO, OVERRIDE AND VALVE POSITION.....</b>	<b>14</b>
3.7.1.	Loop Summary Parameters.....	15
3.8.	<b>BACKPAGE.....</b>	<b>16</b>
3.9.	<b>BACKSCROLL .....</b>	<b>16</b>
3.10.	<b>JUMP TO HOME DISPLAY .....</b>	<b>16</b>
3.11.	<b>INVALID KEY ACTIONS.....</b>	<b>16</b>
3.12.	<b>PARAMETER AVAILABILITY AND ALTERABILITY .....</b>	<b>17</b>

### 3. Chapter 3 PRINCIPLE OF OPERATION

This chapter explains how to locate and change the value of parameters using the front panel buttons. Operation of these buttons changes the display view by bringing up different pages. The pages and the location of parameters within these pages follows a set order. This chapter describes how to navigate between the pages.

---

**Note:** The 2604 controller is an application specific controller and can be configured to the preferences of a particular process, site or even user. This means that the displays shown in this and following chapters may not be identical to those shown in your instrument. Where the text on a display is user configurable it is shown in italics, eg *Loop1*

---

#### About this chapter

This chapter describes:

- ◇ How to change setpoint
- ◇ The operator buttons
- ◇ Parameters and how to access them
- ◇ Pages
- ◇ How to step through pages
- ◇ How to step through parameters
- ◇ How to change parameter values
- ◇ The navigation diagram
- ◇ Parameter tables



### 3.1. POWER UP

Install and wire up the controller in accordance with Chapter 2 and switch on. A short self test sequence takes place during which the controller identification is displayed together with the version number of software fitted.

#### 3.1.1. The HOME Page

The controller then shows a default display, referred to as the HOME page. It is possible to customise all three readouts of this display but the format is shown in Figure 3-2. It is also the default display on a new controller.

The HOME page will be displayed under the following conditions:-

1. When the controller is switched on
2. When the access mode is changed from configuration level to a different level
3. When  and  are pressed together (see 3.10)
4. When a timeout (if configured) occurs

The upper and middle readouts can be configured to display any available parameter but the default is Process Variable and Setpoint respectively.

The lower readout can be configured to show:-

1. Loop Views - LP1 to LP3 as shown
2. The Access page (see Chapter 4)
3. The Summary page (see Chapter 5)
4. The Run page (see Chapter 6)
5. Cycle each loop. LP1 to LP3 pages are cycled in turn



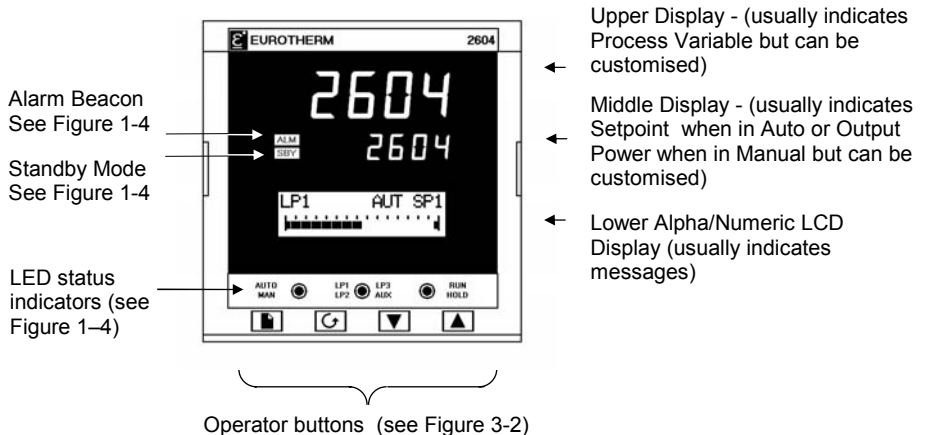



The configuration of these displays is described in the Engineering manual, Part No. HA026761.

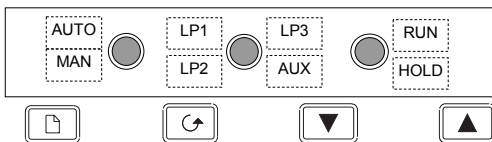

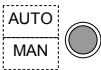
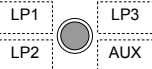
**Figure 3-1: The 'HOME' Page (default)**

### 3.2. THE OPERATOR BUTTONS



	<p>Auto/Manual button</p>	<p>When pressed, this toggles between automatic and manual mode:</p> <ul style="list-style-type: none"> <li>• If the controller is in automatic mode the AUTO light will be on</li> <li>• If the controller is in manual mode, the MAN light will be on</li> </ul>													
	<p>Loop select button</p> <p>The auxiliary loop (A) is used for ratio, cascade or override control only</p>	<p>Each press selects:</p> <table border="0"> <tr> <td>Loop 1</td> <td>LP1 illuminates</td> <td rowspan="6">} If configured</td> </tr> <tr> <td>Loop 1A</td> <td>LP1 + AUX illuminates</td> </tr> <tr> <td>Loop 2</td> <td>LP2 illuminates</td> </tr> <tr> <td>Loop 2A</td> <td>LP2 + AUX illuminates</td> </tr> <tr> <td>Loop 3</td> <td>LP3 illuminates</td> </tr> <tr> <td>Loop 3A</td> <td>LP3 + AUX illuminates</td> </tr> </table> <p>Back to Loop 1</p>	Loop 1	LP1 illuminates	} If configured	Loop 1A	LP1 + AUX illuminates	Loop 2	LP2 illuminates	Loop 2A	LP2 + AUX illuminates	Loop 3	LP3 illuminates	Loop 3A	LP3 + AUX illuminates
Loop 1	LP1 illuminates	} If configured													
Loop 1A	LP1 + AUX illuminates														
Loop 2	LP2 illuminates														
Loop 2A	LP2 + AUX illuminates														
Loop 3	LP3 illuminates														
Loop 3A	LP3 + AUX illuminates														
	<p>Programmer button</p> <p>See also Chapter 4 'Programmer Operation'</p>	<p>This button operates the programmer on all loops</p> <ul style="list-style-type: none"> <li>• Press once to start a program (RUN light on.)</li> <li>• Press again to hold a program (HOLD light on)</li> <li>• Press again to cancel hold and continue running (HOLD light off and RUN light ON)</li> <li>• Press and hold in for two seconds to reset a program (RUN and HOLD lights off)</li> </ul> <p>The RUN light will flash at the end of a program. The HOLD light will flash during holdback.</p>													
	<p>Page button</p>	<p>Press to select the Page Header 'Menu'.</p>													
	<p>Scroll button</p>	<p>Press to select a new parameter from the page heading. If held down it will continuously scroll through the parameters.</p>													
	<p>Down button</p>	<p>Press to decrease an analogue value, or to change the state of a digital value</p>													
	<p>Up button</p>	<p>Press to increase an analogue value, or to change the state of a digital value</p>													

Note:- If buttons do not operate they may have been disabled in configuration level. AUTO, LOOP, or PROG can be disabled individually OR all buttons may be disabled.

**Figure 3-2: Operator Buttons**

### 3.3. THE AUTO MANUAL BUTTON

The controller has two basic modes of operation:

- **Automatic Mode** in which the output is automatically adjusted to maintain the process value at the setpoint .
- **Manual Mode** in which you can adjust the output independently of the setpoint.

The Auto/Manual button can only be operated from the loop view. Press the Loop Select button to select the loop view, then press **AUTO/MAN** to toggle between auto and manual. When the controller is in **AUTO**, 'AUT' will be displayed on the loop summary page as shown in Figure 3-3 (LP1). The middle readout will default to the **Working Setpoint** in a standard controller.

When the controller is in **MANUAL**, 'MAN' will be displayed on the loop summary page as shown in Figure 3-3 (LP2). The middle readout will default to **Output Power** in a standard controller.

If the loop summary page is not being displayed, pressing the AUTO/MAN button will select the first available loop summary. Subsequent presses will change between Auto and Manual for the selected loop as above.

### 3.4. THE RUN/HOLD BUTTON

If the controller is configured as a programmer this button has three functions:

- To put the programmer into **RUN** mode. This causes the working setpoint to follow the profile set in the program being used.
- To put the programmer into **HOLD** mode. This stops the program from running and maintains the setpoint at the current level..
- To put the programmer into **RESET** mode. This resets the programmer to the controller setpoint, the working setpoint can be changed manually using the Raise/Lower buttons.

If the controller is in reset or hold mode, press the RUN/HOLD button. The program begins to run, and the RUN LED illuminates.

If the controller is in run mode, press the RUN/HOLD button. The program will hold at its current conditions, and the HOLD LED illuminates.

If the controller is in run or hold mode, press the RUN/HOLD button and hold it pressed for two seconds. The program will reset, and the RUN and HOLD LEDs will extinguish.

This button operates all programmer loops simultaneously.

See also Chapter 4, 'Programmer Operation'.

### 3.5. THE LOOP SELECT BUTTON

The 2604 controller can be supplied with up to three control loops. The Loop Select button allows you to select a summary of each loop from whatever page is being displayed at the time. Each press of the Loop Select button will change the display to the next loop summary. (If only one loop is configured further presses of the loop button have no effect).

A loop is designated by the mnemonic ‘LP’ followed by the loop number. If the loop is ratio, cascade or override the loop number may be followed by the character ‘A’. This shows a summary of the ‘inner’ or ‘auxiliary’ loop. This text could, however, have been replaced by user defined text.

In addition, each press of the loop select button causes the relevant beacon, LP1 to LP3, to illuminate to indicate which main loop is selected. If the auxiliary loop is configured the AUX beacon will also illuminate.

**The upper and middle displays will show the PV and SP of the loop selected, (see also section 3.7).**

To return to the original page view at any time, press the page button, . Alternatively, a timeout may have been set which will return the display to the HOME page view after a set period. The timeout and period is set in configuration level, see Engineering Manual part no HA026761.



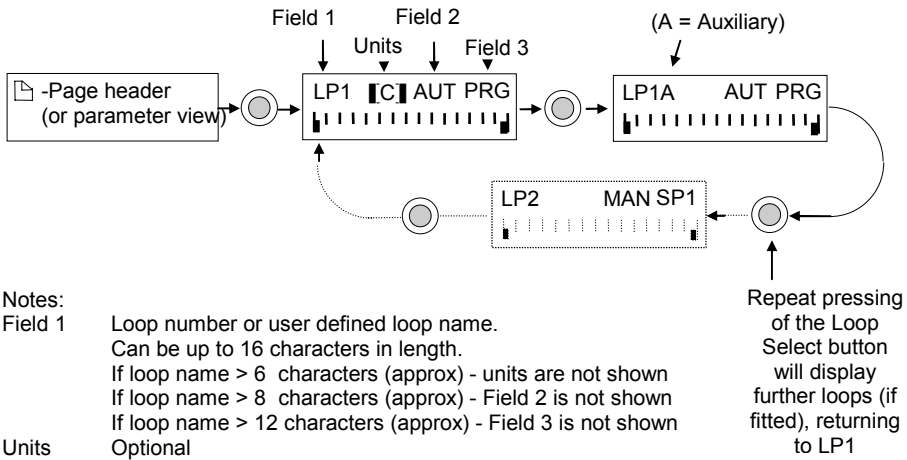



**Typical example of the loop summary display - the bar graph shows output power**







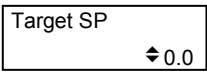

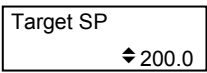
- Notes:
- Field 1 Loop number or user defined loop name.  
Can be up to 16 characters in length.  
If loop name > 6 characters (approx) - units are not shown  
If loop name > 8 characters (approx) - Field 2 is not shown  
If loop name > 12 characters (approx) - Field 3 is not shown
  - Units Optional
  - Field 2 AUT(o)/MAN(ual) or CSD(cascade)/RAT(io)/OVR(override).
  - Field 3 Setpoint source - SP1/SP2/REM(ote)/PRG(program)

**Figure 3-3: Operation of the Loop Button**

### 3.5.1. To Change Setpoint (when the loop is in Auto)

Do This	This Is The Display You Should See	Additional Notes
1. From any display press the Loop Select button,  as many times as necessary to select the required loop number		This is the loop overview
2. Press  or  to select the <b>Target SP</b>		If no key is pressed for 5secs the display returns to the loop overview
3. Press  or  again to raise or lower the setpoint.		The lower readout will blink to accept the new value. At the same time the middle readout will also update.

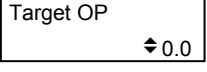
### 3.5.2. To Change Output Power (when the loop is in Manual)

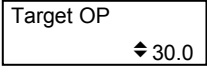
Do This	This Is The Display You Should See	Additional Notes
1. From any display press the Loop Select button,  as many times as necessary to select the required loop number		This is the loop overview
2. Press  or  to select the <b>Target OP</b>		If no key is pressed for 5secs the display returns to the loop overview
3. Press  or  again to raise or lower the output power.		The output power increases or decreases continuously whilst the raise/lower keys are held down. At the same time the middle readout will also update.

If a loop is configured as Cascade, Ratio, Override or motor valve position the names of parameters shown above will differ slightly. These are explained in section 3.7.

### 3.6. PARAMETERS AND HOW TO ACCESS THEM

Parameters are settings, within the controller, which determine how the controller will operate. They are accessed using the lower alpha-numeric display and can be changed by the user to suit the process. Selected parameters may be protected under different security access levels.

Examples of parameters are:-

**Values** - such as setpoints, alarm trip levels, high and low limits, etc.,

or

**States** - such as auto/manual, on/off, etc. These are often referred to as enumerated values.

#### 3.6.1. Pages

The parameters are organised into different pages. A page shows information such as page headers, parameter names and parameter values.

Parameters are grouped in accordance with the function they perform. Each group is given a '**Page Header**' which is a generic description of the parameter group. Examples are 'The Alarm Page', 'The Programmer Page', etc,. A complete list of pages is shown in the navigation diagram in the Engineering manual.

The 2604 contains a set of default pages for most applications. It is possible to configure different start up pages as the Home page, but the principle of navigation is the same as the default pages.

**Note:-**

**A page only appears on the controller if the function has been ordered and has been enabled in Configuration mode. For example, if a programmer is not configured the RUN page and the EDIT PROGRAM pages will not be displayed.**

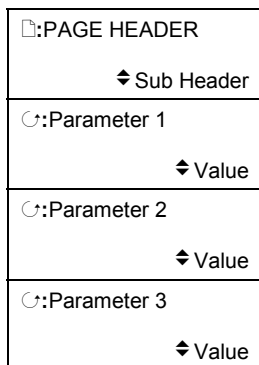

**Figure 3-4: Page Concept**



### 3.6.2. To Step Through Page Headers

Press  - (The Page Button).

At each press the first line of the alpha-numeric display will change to the name of the **page header**. This is a continuous list which will eventually return to the starting point, as shown in Figure 3-5 below. If the page button, , is held down continuously the pages auto advance.

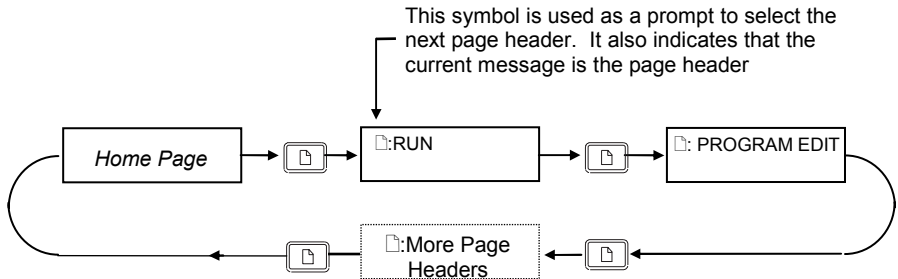



☺ Tip: See 'Backpage' Section 3.7

Figure 3-5: Stepping Through Page Headers

### 3.6.3. Sub-headers

The page header shown in Figure 3-6 contains sub-headers.. The sub-header appears in the lower right hand corner of the alpha-numeric display.

The sub-header can be changed using the  or  buttons, as prompted by the  symbol. This is a continuous list which will return to the first sub-header.

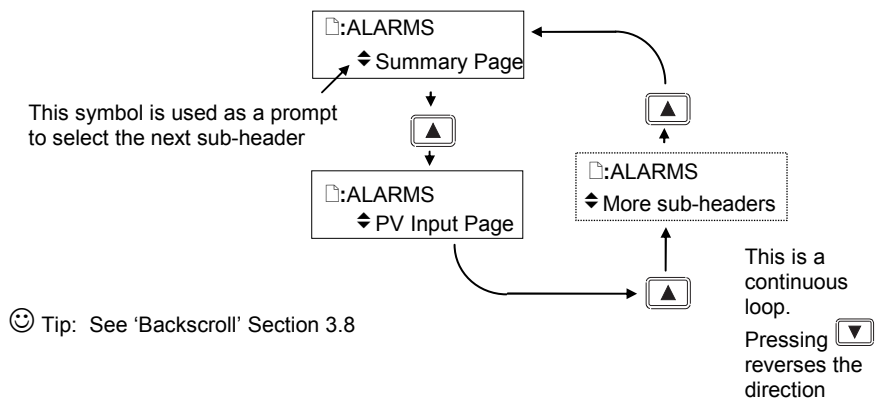

☺ Tip: See 'Backscroll' Section 3.8

Figure 3-6: Sub-header Selection

### 3.6.4. To Step Through Parameters

When the page header (and sub-header) which contains the required parameter has been selected :-

Press  - (The Scroll Button)

This will access the first parameter on the page. At each subsequent press the next parameter in the list is displayed. This is a continuous list which will eventually return to the list header.

If the scroll button, , is held down the parameters auto advance.

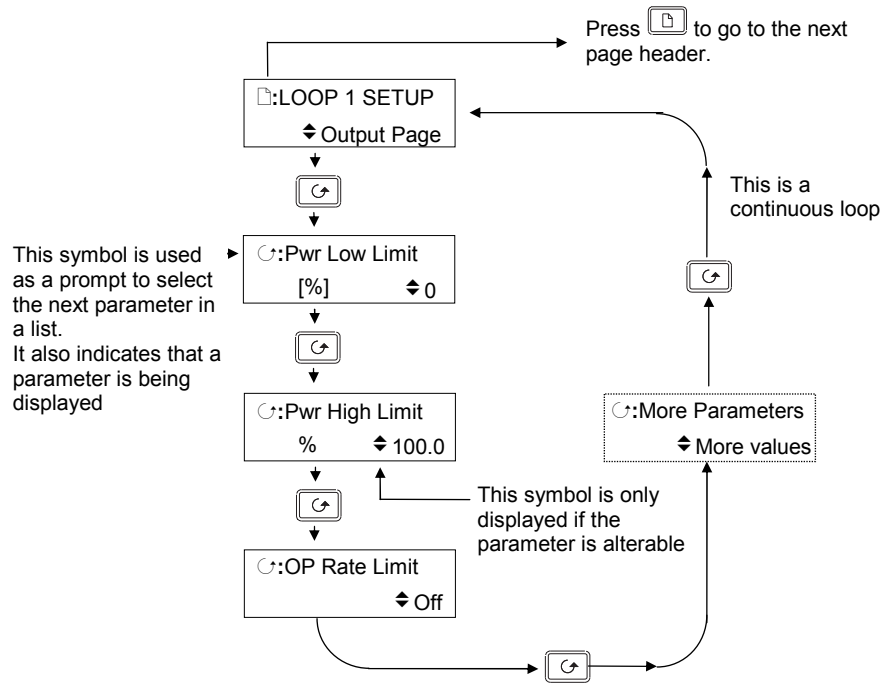

 Tip: See 'Backscroll' Section 3.8



Figure 3-7: Parameter Selection

 Tip:- To return to the Page Header at any time press .

### 3.6.5. To Change Parameter Values

When the required parameter has been selected its value is shown in the lower part of the alpha-numeric readout.



To change a parameter value press  or  - (The Raise or Lower Buttons)

If an attempt is made to change a read only parameter, the parameter value will be replaced by ----- as long as the  or  buttons are held. For many parameters an upper and lower limit can be set. When changing a parameter value its new value must be within these limits.

Parameter values can be displayed in different ways depending upon the parameter type. Figure 3-8 below shows the different types of parameter and how their values are changed.



#### 1. Numerical Values

:Pwr High Limit  
◆ 100.0

Press  to increase the value  
← Press  to decrease the value



#### 2. Enumerated Values

:Program Status  
◆ Reset

Press  to show next state  
← Press  to show previous state



#### 3. Digital Values (e.g. programmer event outputs)

Prg: 1 Seg: 4  
□□□□□□□□□□□□

Press  to step along the values. The selected value flashes.  
← Press  or  to turn the value on or off



#### 4. Parameter Addresses

:Upper Param  
◆ 00001: L1.PV

Press  or  to change the **Parameter address**. A cursor flashes under the parameter address indicating that it can be changed  
← The parameter name for that address (if it exists) is shown in the lower right of the readout

Press  to change from parameter address to parameter name

:Upper Param  
◆ 00001: L1.PV

Press  or  to change the **parameter name**. A cursor flashes under the parameter name indicating that it can be changed

Note:- The above examples are generally only available in configuration level, but are included here to illustrate the principle of operation.

Figure 3-8: Changing a Parameter Value

## 5. Text (User definable)

The first character alternates between the character and \_ indicating that it can be changed

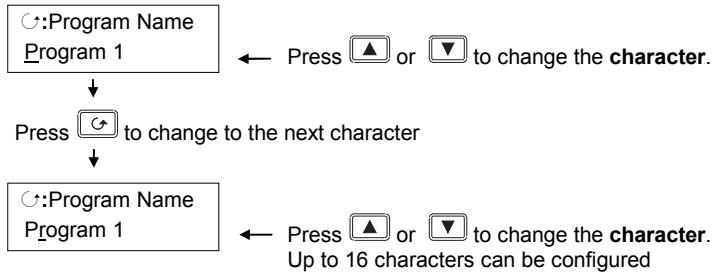

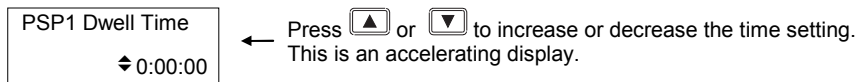

😊 Tip: See 'Backscroll' Section 3.8 if you need to re-enter a previously entered character.

## 6. Time



**Figure 3-9: Changing a Parameter Value (continued)**

### 3.6.5.1. CONFIRMATION MECHANISM

When the  or  key is released, the display will blink after a period of 1.5 seconds, indicating that the new parameter value has been accepted. If any other key is pressed during the 1.5 second period the parameter value is accepted immediately.

There are exceptions for specific parameters. Examples of these are:-

**Output Power** adjustment when in Manual mode. The value is written continuously as the value is changed.

**Alarm Acknowledge.** If the Alarm Acknowledge is changed from 'No' to 'Acknowledge' a confirmation message appears. Press  key to confirm the change. If no key is pressed for 10 seconds the value is restored to its previous value.

### 3.6.6. Parameter Tables

In subsequent chapters parameters are listed in tables. The format of these tables is shown in the example below:-

- Column 1 gives the name of the parameter as it appears on the lower readout of the alphanumeric display.
- Column 2 is a description and possible usage of the parameter
- Column 3 is the range of values which can be set. . This may be a numerical value, eg -n to +n, or the condition (enumeration) of a parameter, eg the parameter 'Program Status' has enumerations 'Run', 'Hold', 'Reset'.
- Column 4 is the default value of the parameter set during manufacture
- Column 5 is the access level required to change the value of the parameter. R/O is Read Only.

<b>Table Number:</b> (same as section)		<b>Description of the page</b>			<b>Page Header</b>
<b>1</b> <b>Parameter Name</b>	<b>2</b> <b>Parameter Description</b>	<b>3</b> <b>Value</b>	<b>4</b> <b>Default</b>	<b>5</b> <b>Access Level</b>	
Program Number	The number of the selected program			L1	
Segment Number	The currently running segment number			L1	
PSP1 Type	Program Setpoint 1 type			L1	
PSP1 Working SP	Program Setpoint 1 working setpoint			L1	
PSP1 Target	Program Setpoint 1 target setpoint			L1	
PSP1 Dwell Time	Program Setpoint 1 dwell time			L1	
This is a continuous loop which returns to the list header					

This User Guide generally includes parameters in Operation Level (Level 1). In some cases, where it is relevant to the description of a feature, a parameter shown in Level 2 or 3 may also be included.

It should also be noted that a parameter or a list of parameters can be promoted from a higher level (L3) to a lower level (L1) when the controller is configured by the user. If this has been done it will be necessary to refer to the 2604 Engineering Handbook, part number HA 026761, for further information.

Any parameter available in a lower access level is also available in a higher level.

**Note:-**

**A parameter only appears if it is relevant to the configuration of the controller. For example, a programmer configured as Time to Target will not display the Rate parameter.**



### 3.7. SPECIFIC DISPLAYS FOR CASCADE, RATIO, OVERRIDE AND VALVE POSITION

When the loop select button is pressed the upper and middle readouts generally show PV and SP, see section 3.5. If the loops are configured as Cascade, Ratio, Override or Motor Valve Control the parameters displayed, specific to these configurations, are shown in the table below:-

Loop	Main				Aux			
	Auto		Manual		Auto		Manual	
Type	Upper	Middle	Upper	Middle	Upper	Middle	Upper	Middle
Single	PV	WSP	PV	WOP	-	-	-	-
Cascade	PV	WSP	PV	WOP	Aux PV	Aux WSP	Aux PV	WOP
Override	PV	WSP	PV	WOP	Aux PV	Aux WSP	Aux PV	WOP
Ratio	PV	WSP	PV	WOP	Ratio PV	Ratio SP	Ratio PV	WOP

If any loop is configured as Valve Position, WOP is replaced by Valve Position

In sections 3.5.1 and 3.5.2 it was shown how to access and change Setpoint when in Auto and Output Power when in Manual. If the loops are configured as Cascade, Ratio, Override or Motor Valve Control the specific parameters displayed are shown in the table below:-

From the bar-graph display press  or 

Loop	Main		Aux	
	Auto Main Loop	Manual Main Loop	Auto Aux Loop	Manual Aux Loop
Single	Target SP	Target OP	-	-
Cascade	Target SP	Target OP	Target SP	Target OP
Override	Target SP	Target OP	Override SP	Target OP
Ratio	Target SP	Target OP	Ratio SP	Target OP

If any loop is configured as Valve Position, Target OP is replaced by Valve Position

If cascade is disabled Target SP reverts to Local SP.

### 3.7.1. Loop Summary Parameters

When the Loop Select Button is pressed a summary of the loop is displayed as shown in Figure 3-3.



Press  button to access up to 10 additional parameters which may have been promoted, in configuration level, to the loop summary page. If the loop types are configured as cascade, ratio or override some of these 10 parameters are pre-defined as shown in the following table.

Loop Type	Main	Aux
Single	Working OP Target SP Plus up to 8 promoted parameters	-
Cascade	Working OP Target SP Disable Csd Plus up to 7 promoted parameters	Working OP Target SP Disable Csd Plus up to 7 promoted parameters
Override	Working OP Target SP Disable OVR Active Loop Main OP Override OP Plus up to 4 promoted parameters	Working OP OVR Target SP Disable OVR Active Loop Main OP Override OP Plus up to 4 promoted parameters
Ratio	Working OP Target SP Enable Ratio Ratio Trim Lead PV Plus up to 5 promoted parameters	Working OP Ratio SP Enable Ratio Ratio Trim Lead PV Plus up to 5 promoted parameters

Note. If any of the loops have been configured as a programmer, the Working OP parameter is preceded by the Program Loop Summary display shown below:-



Prg: 1    Seg: 4 <i>Program Name</i>
---

### 3.8. BACKPAGE

When stepping through list headers, a backpage short cut is provided by holding down  and press . Each press of  will step back one position of the list header in a continuous loop.



This function is provided as a short cut and is not necessary to navigate through the pages.

### 3.9. BACKSCROLL

When stepping through parameters in a list, a backscroll short cut is provided by holding down  and pressing . Each press of  will step back to the previous parameter, until the page header is reached.

This function is provided as a short cut and is not necessary to navigate through the parameters.



### 3.10. JUMP TO HOME DISPLAY

Press  and  together to return the display to the configured HOME screen.

### 3.11. INVALID KEY ACTIONS

At any time some state transitions may be invalid, due, for example, to contention with digital inputs or to the current operating state of the instrument.

Examples are:-

1. Digital inputs have priority over the operator buttons.
2. If a parameter value cannot be changed the  prompt is not shown
3. If the  or  button is pressed for a read only parameter a number of dashes, ----, is displayed.



### 3.12. PARAMETER AVAILABILITY AND ALTERABILITY

A parameter which appears on a page is described as available. Parameters are not available if they are not appropriate for a particular configuration or instrument status. For example, relative cool gain does not appear in a heat only controller, and integral time does not appear in an On/Off controller.

A parameter described as alterable is, generally, preceded by the  $\blacklozenge$  symbol which indicates that its value can be changed. A parameter which is not alterable may be viewed (subject to availability), but may be changed by an instrument algorithm.

A parameter is alterable only if the following conditions are satisfied:-

- The parameter is READ/WRITE
- The parameter does not conflict with the status of the instrument. For example, the proportional band will not be alterable if autotune is active
- The instrument keys must be enabled. Keys can be disabled by a logic input, turned off in configuration level or via digital communications. A logic input can be configured to disable front panel keys; this will not remove remote control of the user interface via digital communications.

The Navigation Diagram which follows shows all pages which are available at Level 3. For a particular configuration not all pages are displayed on the controller. For example:- the programmer pages do not appear if a programmer is not configured; the Loop 2 and 3 set up pages do not appear for a single loop controller.

Any one or all of the pages shown in the navigation diagram can also be displayed at Level 1 & 2. This, however, will have been pre-set in Configuration Level (see 2604 Engineering Manual Part No HA026761).



<b>4.</b>	<b>CHAPTER 4 PROGRAMMER OPERATION .....</b>	<b>2</b>
4.1.	CUSTOMISABLE PARAMETER NAMES .....	2
4.2.	WHAT IS SETPOINT PROGRAMMING ? .....	3
4.3.	SETPOINT PROGRAMMER DEFINITIONS .....	4
4.3.1.	Run .....	4
4.3.2.	Hold .....	4
4.3.3.	Reset .....	4
4.3.4.	Servo .....	4
4.3.5.	Hot Start .....	4
4.3.6.	Power Fail Recovery.....	4
4.3.7.	Holdback (Guaranteed Soak).....	5
4.3.8.	External Program Inputs .....	5
4.3.9.	Wait .....	6
4.4.	PROGRAMMER TYPES .....	7
4.4.1.	Time To Target Programmer .....	7
4.4.2.	Ramp Rate Programmer .....	7
4.5.	SEGMENT TYPES .....	7
4.5.1.	Profile .....	7
4.5.2.	Go Back Segment .....	8
4.5.3.	End Segment.....	8
4.6.	OTHER FEATURES NOT COVERED IN THIS USER GUIDE .....	8
4.7.	PROGRAMMER OPERATION .....	9
4.7.1.	To Run, Hold or Reset a Program .....	9
4.7.2.	Run Parameters.....	10
4.8.	TO CREATE OR EDIT A PROGRAM.....	14
4.8.1.	To Define Parameters Common To A Program.....	15
4.8.2.	PROGRAM EDIT (Program Page) Parameters.....	16
4.8.3.	To Set Up Each Segment Of A Program .....	18
4.8.4.	PROGRAM EDIT(Segment Page) Parameters.....	19
4.9.	EXAMPLES .....	21
4.9.1.	Program Data Entry Example in a Ramp Rate Programmer .....	21
4.9.2.	Prog Data Entry Example - Time to Target Programmer .....	23
4.9.3.	Holdback Example .....	24
4.9.4.	Wait Example .....	25
4.9.5.	Program Names example .....	27

---

## 4. Chapter 4 PROGRAMMER OPERATION

This chapter explains Setpoint Programming and how to Create, Edit and Run programs. Parameters which are associated with setpoint program operation are also listed in tables as a general reference.

---

**Note:** The 2604 controller is an application specific controller and can be configured to the preferences of a particular process, site or even user. This means that the displays shown in this and following chapters may not be identical to those shown in your instrument. Displays shown in *italics* are user definable and may, therefore, vary between instruments.

---

### About this Chapter

This chapter describes:

- ◇ The meaning of setpoint programs
- ◇ Setpoint programming terminology
- ◇ Programmer types
- ◇ How to run, hold or reset a program
- ◇ How to create or edit a program
- ◇ Examples of how to set up specific features of a program

### 4.1. CUSTOMISABLE PARAMETER NAMES

Throughout this chapter parameter names shown in *italics* are customisable by the user when in configuration access level. The name of the parameter may vary, therefore, from instrument to instrument.

Typical customisable parameter names are:

- Program names
- Profile Setpoint names
- Segment names

## 4.2. WHAT IS SETPOINT PROGRAMMING ?

In a setpoint programmer you can set up a profile in the controller in which the setpoint varies in a pre-determined way over a period of time. Temperature is a very common application where it is required to 'ramp' the process value from one level to another over a set period of time.

The 2604 controller will program up to three separate profiles. These may be temperature, pressure, light level, humidity, etc., depending on the application, and are referred to as **Profiled Setpoints (PSPs)**.

The **Program** is divided into a flexible number of **Segments** - each being a single time duration, - and containing details for each profiled setpoint. The total number of segments available is **100 per program** with a **maximum of 500**.

The 2604 programmer may store up to 20 programs as standard, with up to 50 if purchased, and works on a single timebase for all programs.

It is often necessary to switch external devices at particular times during the program. Digital 'event' outputs can be programmed to operate during those segments.

An example containing three profile setpoints and two event outputs is shown below.

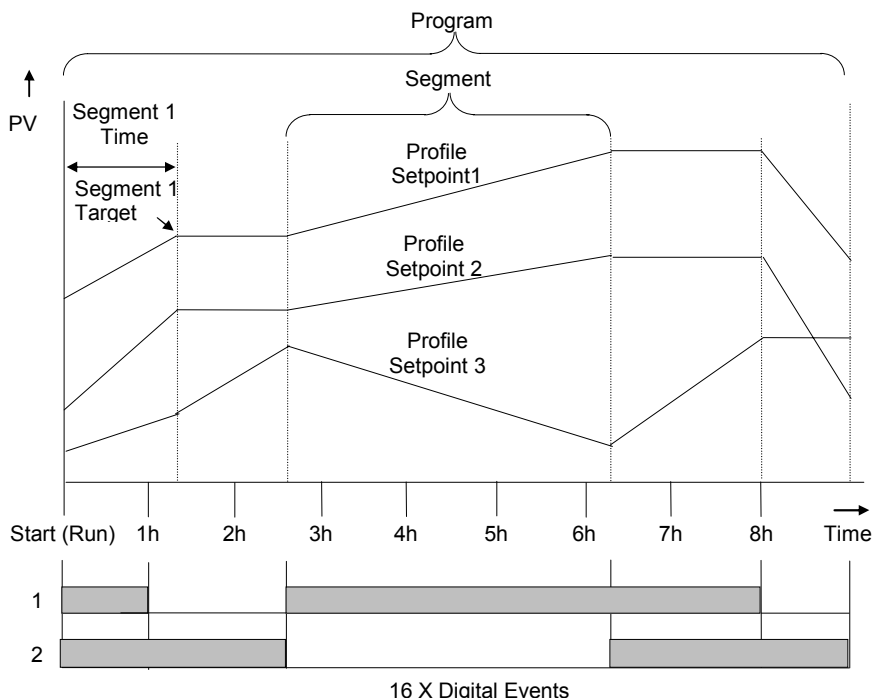

**Figure 4-1: A Setpoint Program**

### 4.3. SETPOINT PROGRAMMER DEFINITIONS

This section defines the more common parameters to be found when running a 2604 programmer /controller. For an explanation of further features see the Engineering Handbook part no HA026761.

#### 4.3.1. Run

In run the programmer varies the setpoint in accordance with the profile set in the active program.

#### 4.3.2. Hold

In hold the programmer is frozen at its current point. In this state you can make temporary changes to program parameters such as a target setpoint, ramp rates and dwells (if programmer configured for ramp rate) or segment duration (if programmer configured as Time to Target). Such changes will only remain effective until the end of the currently running segment, when they will be overwritten by the stored program values.

#### 4.3.3. Reset

In reset the programmer is inactive and the controller behaves as a standard controller, with the setpoint determined by the raise/lower buttons.

#### 4.3.4. Servo

Servo can be set in configuration so that when a program is run the setpoint can start from the initial controller setpoint or from the current process value. Whichever it is, the starting point is called the servo point. This can be set in the program.

Servo to PV will produce a smooth and bumpless start to the process.

Servo to SP may be used in a Ramp Rate programmer to guarantee the time period of the first segment. (Note: in a Time to Target programmer the segment duration will always be determined by the setting of the Segment Duration parameter.)

#### 4.3.5. Hot Start

Hot start can occur in any segment type, for any PSP but is most useful to ramp segments.

When run is initiated it allows the program to automatically advance to the correct point in the profile which corresponds to the operating temperature of the process. Hot start is enabled in configuration level and specifies which programmed variable to use when deciding the correct segment.

#### 4.3.6. Power Fail Recovery

In the event of power fail to the controller, a strategy may be set in configuration level, which defines how the controller behaves on restoration of the power. These strategies include:

Continue	The program runs from the last setpoint. This may cause full power to be applied to the process for a short period to heat the process back to its value prior to the power failure
Ramp back	This will ramp the process value back to its original value at a controlled rate. This will be the last encountered rate.
Reset	The process is aborted by resetting the program

### 4.3.7. Holdback (Guaranteed Soak)

Holdback freezes the program if the process value (PV) does not track the setpoint (SP) by an amount that can be set by the user. It may operate in any PSP type.

In a **Ramp** it indicates that the PV is lagging the SP by more than a settable amount and that the program is waiting for the process to catch up.

In a **Dwell** it freezes the dwell time if the difference between the SP and PV exceeds settable limits.

In both cases it guarantees the correct soak period for the product.

**Example:** Holdback applied to a ramp up and a dwell.

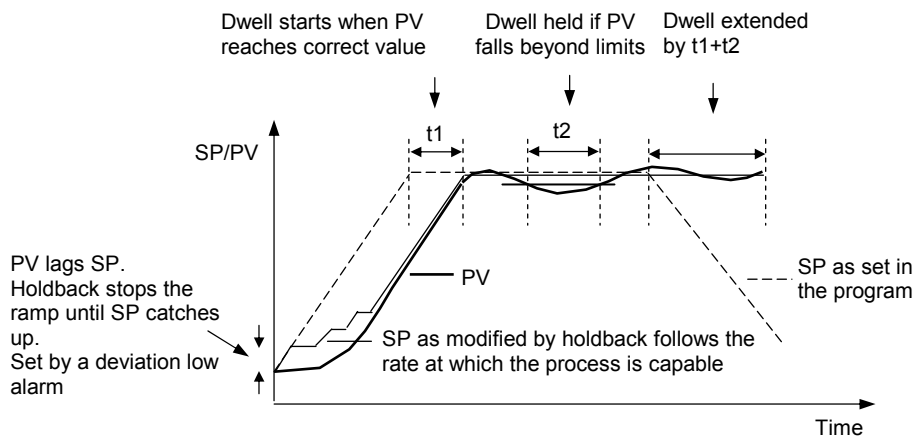

**Figure 4-2: Effect of Holdback to Produce Guaranteed Soak**

### 4.3.8. External Program Inputs

Digital inputs may have been configured to allow the program to be operated by external sources.

Run	Allows the program to be run from a pushbutton or other event
Hold	Allows the program to be held from a switch or other event.
Reset	Allows the program to be reset from a pushbutton or other event.
Run/Hold	Allows the program to be run or held from a single external source
Run/Reset	Allows the program to be run or reset from a single external source
Advance Segment	Selects the next segment from an external source
Advance Program	Selects the next program from an external source. When this event occurs, the controller display will change to programmer view. Subsequent changes of this source will cause the program number to increment.
Holdback disabled	Disables holdback from an external source

### 4.3.9. Wait

An event can be configured at the end of each segment, which, when active, will cause the program to wait before progressing to the next segment. Three wait conditions are provided which may be wired, in configuration level, to an external source using digital inputs or to internal sources, e.g. a loop alarm. Each segment may then select No-Wait, Wait on Event A, Wait on Event B or Wait on Event C. The program will not proceed until all profile segments are complete.

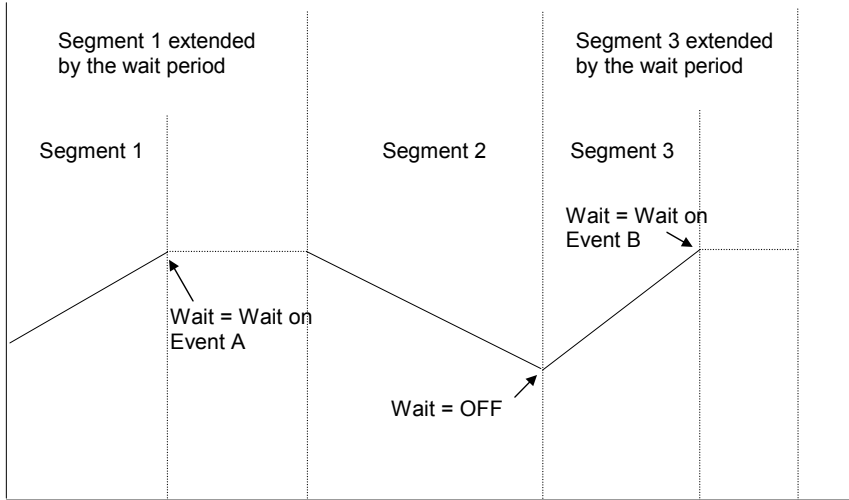
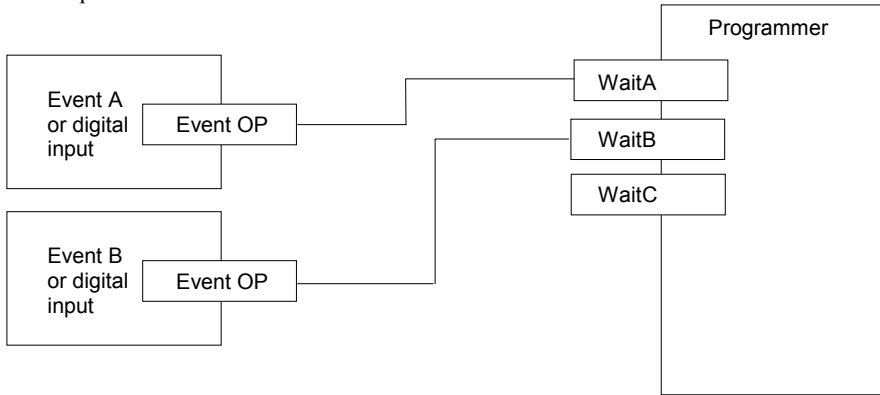

Figure 4-3: Wait Events



## 4.4. PROGRAMMER TYPES

The programmer can be configured as **Time to Target** or **Ramp Rate**. A time to target programmer requires fewer settings and is simple to use since all segments are the same. A time to target programmer can, in general contain more segments than a ramp rate.

### 4.4.1. Time To Target Programmer

Each segment consists of a **single duration parameter** and a set of **target values** for the profiled variables.

1. The **duration** specifies the time that the segment takes to change the profiled variables from their current values to the new targets.
2. A **dwell** type segment is set up by leaving the target setpoint at the previous value.
3. A **Step** type segment is set up by setting the segment time to zero.

### 4.4.2. Ramp Rate Programmer

Each segment can be specified as **Ramp Rate, Dwell or Step**.



1. Each profiled setpoint must complete its segment before the programmer will move to the next segment. If one ramp reaches its target setpoint ahead of the other variables, it will dwell at that value until the other variables have completed. The program will then move to the next segment.
2. The duration parameter for a segment is read only unless the segment contains only dwells. In this case the dwell period can be changed when the program is in Hold..
3. The duration is determined by the longest profile setting.

## 4.5. SEGMENT TYPES

A segment type can be defined as **Profile, Go Back** or **End**.

### 4.5.1. Profile

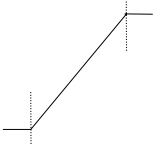
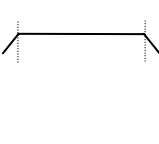
A profile segment may be set as:-

<b>Ramp</b>		<b>The setpoint ramps linearly</b> , from its current value to a new value, either at a set rate (called <i>ramp-rate programming</i> ), or in a set time (called <i>time-to-target programming</i> ). You must specify the ramp rate or the ramp time, and the target setpoint, when creating or modifying a program.
<b>Dwell</b>		<b>The setpoint remains constant</b> for a specified period at the specified target. When creating programs the target is inherited from the previous segment. When editing an existing program it is necessary to re-enter the target value. This allows the dwell target to be matched to a go-back segment.
<b>Step</b>		<b>The setpoint steps instantaneously</b> from its current value to a new value at the beginning of a segment.

### 4.5.2. Go Back Segment

Go Back allows segments in a program to be repeated by a set number of times. It is the equivalent of inserting ‘sub-programs’ on some controllers. Figure 4-4 shows an example of a program which is required to repeat the same section a number of times and then continue the program.

A Go Back segment is used to save the total number of segments required in a program and to simplify setting up. When planning a program it is advisable to ensure that the end and start setpoints of the program are the same otherwise it will step to the different levels. A Go Back segment is defined when editing a program.

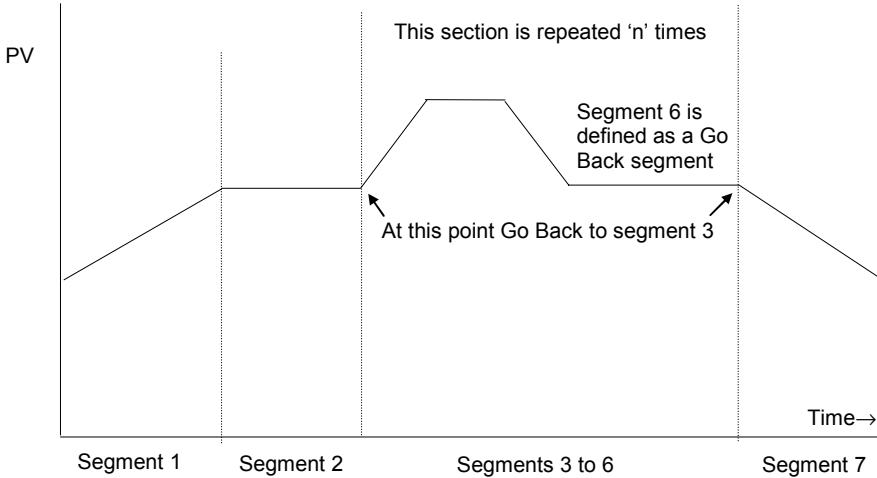

**Figure 4-4: An Example of a Program with Repeating Section**

### 4.5.3. End Segment

The last segment in a program is normally defined as an End segment

**The program either ends, repeats or resets in this segment.** You specify which is the case when you create, or modify, the program. When the program ends, the programmer is put into either, a continuous dwell state with all outputs staying unchanged, or the reset state.

## 4.6. OTHER FEATURES NOT COVERED IN THIS USER GUIDE

Other programmer features, described in the Engineering Handbook, are:-

- Program User Values Chapter 6
- Pattern Generator Chapter 14
- Program, Segment and other user defined names Chapter 6









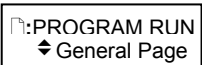

## 4.7. PROGRAMMER OPERATION

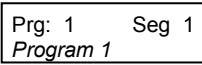
### 4.7.1. To Run, Hold or Reset a Program

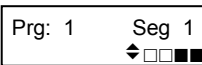
A selected program may be run, reset or held as follows:

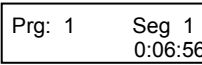
1. Press the RUN/HOLD button once, the RUN beacon will illuminate. Press the RUN/HOLD button again, the HOLD beacon will illuminate. Press and hold the RUN/HOLD button for 3 seconds, the program will reset and both beacons will extinguish.
2. If digital inputs have been configured and wired for an external RUN, HOLD or RESET, activate the relevant digital input.
3. By selecting the Program Status parameter (in the Run List). This method may be preferred if the number of the program to be run must also be selected.

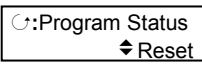
#### 4.7.1.1. To Run, Hold or Reset a Program from the Run List

Do This	This Is The Display You Should See	Additional Notes
1. From any display press  as many times as necessary until the ' <b>PROGRAM RUN</b> ' ( <b>General Page</b> ) header is displayed		This page provides access to parameters of a <b>running program</b> .
2. Press 		Shows selected program number, current segment number and name of the program. Text shown in <i>italics</i> is user definable
3. Press 		Shows the current status of the event outputs. <input type="checkbox"/> = Event On <input checked="" type="checkbox"/> = Event Off Up to 16 may be configured
4. Press 		Shows the program time remaining
5. Press  until ' <b>Program Status</b> ' is displayed		The choices are:- <b>Run</b> see 4.3.1 <b>Hold</b> see 4.3.2 <b>Reset</b> see 4.3.3
6. Press  or  to select ' <b>Run</b> '		

### 4.7.2. Run Parameters

The Run list provides status information on a running program, as follows:-

Table Number: 4.7.2a.		These parameters show the status of the overall program			PROGRAM RUN (General Page)
Parameter Name	Parameter Description	Value	Default	Access Level	
These displays may be promoted by the user as an over-view of the program status	<div style="border: 1px solid black; padding: 5px; display: inline-block;">                     Prg: 1    Seg: 4  <i>Program Name</i> </div>	Program Number Segment Number Program Name		R/O	
	<div style="border: 1px solid black; padding: 5px; display: inline-block;">                     Prg: 1    Seg: 4                      □□■□□■□□■□□■                 </div>	Digital outputs states. Only appears if digital outputs configured		L1. Can be changed in Hold	
	<div style="border: 1px solid black; padding: 5px; display: inline-block;">                     Prg: 1    Seg: 4                      d h: m: s                 </div>	Program Time Remaining		R/O	
Fast Run	Allows the program to fast run  <b>Warning!</b> Fast run allows the program to be tested by quickly running through the program segments. If the controller is connected to the process, ensure that it is not affected if fast run is selected.  The default value, <b>No</b> , means that the program will run at the set rate	No Yes		L3. Alterable in reset or complete	
Program Status	Displays the status of the program	Reset Run Hold Complete		L1.	
Prog Time Elap	Program time elapsed	d: h: m: s		R/O	
Prog Cycle Rem	Remaining number of cycles	1 to 999		R/O	
Total Segments	Number of segments in the running program	0 to 100		R/O	
Segment Number	The currently running segment number	1 to 100		R/O	
Segment Type	Running program segment type Profile = normal segment Go Back =repeat part of prog	Profile End Segment Go Back		R/O	

Seg Time Rem	Time remaining in the current segment	d: h: m: s		L1. Read or alterable if Time To Target prog and in Hold
Wait Status	Wait Status	No Wait Event A Event B Event C		R/O
Wait Condition	Wait condition for the running segment	No Wait Event A Event B Event C		L1. Alterable in Hold
Prog User Val 1	Programmer User Value 1 currently active	Usr 0 to 99		L1
Prog User Val 2	Programmer User Value 2 currently active	Usr 0 to 99		L1
PID Set	PID values used in running program	PID Set 1 to PID Set 3		R/O - Only shown if configured
Goback Rem	Number of repeat cycles remaining	1 to 999		R/O
End Action	The state required in the end segment	Dwell Reset		R/O
Prog Reset DO	These are the digital events in Reset  			R/O Only shown if configured.

Note:

The above table shows a complete list of all possible parameters. If a feature is not configured parameters associated with that feature will not show.

<b>Table Number: 4.7.2b.</b>		<b>These parameters are associated with Profiled Setpoint number 1</b>		<b>PROGRAM RUN (PSP1 Page)</b>	
<b>Parameter Name</b>	<b>Parameter Description</b>	<b>Value</b>	<b>Default</b>	<b>Access Level</b>	
Seg Time Rem	Segment time remaining	h: m: s			
PSP1 Type	Running segment type for profiled setpoint 1	Step Dwell Ramp		R/O - shown in Ramp Rate prog.	
PSP1 WSP	Working setpoint for profiled setpoint 1	Display range		L1. Alterable in Hold	
PSP1 Target	Running segment target for profiled setpoint 1	Display range		L1. Alterable in Hold	
PSP1 Dwell Tm	Time remaining in running segment for profiled SP 1	Display range		L1. Alterable in Hold	
PSP1 Rate	Running segment rate for profiled setpoint 1	Display range		L1. Not in Time To Target prog	
PSP1 HBk Appl	Holdback applied for profiled setpoint 1	No Yes		R/O - shown if configured	

1. Range limited by user defined upper and lower limits

Note:

The above table shows a complete list of all possible parameters. If a feature is not configured parameters associated with that feature will not show.

<b>Table Number:</b> 4.7.2c		<b>These parameters are associated with PSP2 and only appear if PSP2 is configured</b>		<b>PROGRAM RUN (PSP2 Page)</b>	
<b>Parameter Name</b>	<b>Parameter Description</b>	<b>Value</b>	<b>Default</b>	<b>Access Level</b>	
Seg Time Rem	Segment time remaining	h: m: s			
PSP2 Type	Running segment type for profiled setpoint 2	Step Dwell Ramp		L1. Read Only shown in Ramp Rate prog.	
PSP2 WSP	Working setpoint for profiled setpoint 2	Display range <sup>1</sup>		L1. Alterable in Hold	
PSP2 Target	Running segment target for profiled setpoint 2	Display range <sup>1</sup>		L1. Alterable in Hold	
PSP2 Dwell Tm	Time remaining in running segment for profiled SP 2	Display range		L1. Alterable in Hold	
PSP2 Rate	Running segment rate for profiled setpoint 2	Display range <sup>1</sup>		L1. Not in Time To Target prog	
PSP2 HBk Appl	Holdback applied for profiled setpoint 2	No Yes		L1. Read only shown if configured	

1. Range limited by user defined upper and lower limits

**Note:**

The above table shows a complete list of all possible parameters. If a feature is not configured parameters associated with that feature will not show.

Table Number: 4.7.2d		These parameters are associated with PSP3 and only appear if PSP3 is configured		PROGRAM RUN (PSP3 Page)	
Parameter Name	Parameter Description	Value	Default	Access Level	
Seg Time Rem	Segment time remaining	h: m: s			
PSP3 Type	Running segment type for profiled setpoint 3	Step Dwell Ramp		L1. Read Only shown in Ramp Rate prog.	
PSP3 WSP	Working setpoint for profiled setpoint 3 <sup>1</sup>	Display range		L1. Alterable in Hold	
PSP3 Target	Running segment target for profiled setpoint 3 <sup>1</sup>	Display range		L1. Alterable in Hold	
PSP3 Dwell Tm	Time remaining in running segment for profiled SP 3	Display range		L1. Alterable in Hold	
PSP3 Rate	Running segment rate for profiled setpoint 3 <sup>1</sup>	Display range		L1. Not in Time To Target prog	
PSP3 HBk Appl	Holdback applied for profiled setpoint 3	No Yes		L1. Read only shown if configured	

<sup>1</sup> Range limited by user defined upper and lower limits

Note:

The above table shows a complete list of all possible parameters. If a feature is not configured parameters associated with that feature will not show.

## 4.8. TO CREATE OR EDIT A PROGRAM











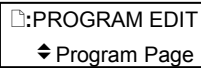

- A running program cannot be edited, it must be put into **Reset** mode.
- Changes can be made to remaining segments of a running program but these are ‘temporary’ changes which apply only to the current run. These changes will not apply to subsequent runs.
- Other programs can be created or edited when another program is running.

To create or edit a program it is first necessary to define the effect that various parameters will have on the overall program. These parameters will be found under the page header **PROGRAM EDIT (Program Page)**, see section 4.8.1. and 4.8.2.

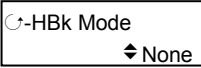
When these parameters have been defined then set up the parameters which define each individual segment. These parameters will be found under the page header **PROGRAM EDIT (Segments Page)**, see section 4.8.3. and 4.8.4.

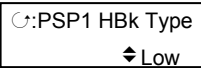

### 4.8.1. To Define Parameters Common To A Program













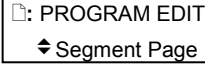

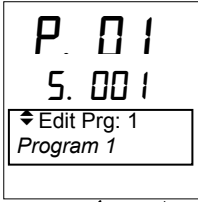

Do This	This Is The Display You Should See	Additional Notes
1. From any display press  as many times as necessary until the ' <b>PROGRAM EDIT</b> ' page header is displayed		The PROGRAM EDIT page is not available in Access levels 1 & 2.  It is available as read only in View Config level
2. Press  if necessary to select ' <b>Program Page</b> '	3. Press  to select ' <b>Edit Prog: 1</b> '. This is the first parameter in the list  4. Press  or  to choose the program number to be edited. The second line of the lower readout will change to the program name. This is shown in <i>italics</i> to indicate that the program name is user definable.	The upper display shows the selected program number.  The middle display shows the total number of segments  Up to 20 programs as standard. 50 programs as an option.
5. Press  to select the next parameter in the list. This is ' <b>HBk Mode</b> '.		This enables Holdback. The choices are:- None Per Program Per Segment
6. Continue pressing  to access the further parameters in this page  7. Continue pressing  or  to change the parameter values or states		Further parameters may be set up in the same way. These are listed together with an explanation of their function in the following table  

### 4.8.2. PROGRAM EDIT (Program Page) Parameters

Table Number: 4.8.2		These parameters affect the overall program. Only shown at Level 3.			PROGRAM EDIT (Program Page)
Parameter Name	Parameter Description	Value	Default	Access Level	
Edit Prg: 1	Selects the program number to be edited	1 to 20 or 1 to 50	1	L1	
Hbk Mode	Holdback mode None = no holdback applied Per prog = common to prog Per seg = active in every segment	None Per Program Per Segment	None	L1	
PSP1 Hbk Type	Holdback type for PSP1 These are deviation values between setpoint and process value	Off Low High Band	Off	L1  Only displayed if Holdback Mode = Per Program	
PSP1 Hbk Value	Holdback value for PSP1	SP1 hi limit to SP1 lo limit	0	L1  Only displayed if Hbk Type ≠ Off	
The next four parameters are only displayed if PSP2 and PSP3 are configured					
PSP2 Hbk Type	Holdback type for PSP2 These are deviation values between setpoint and process value	Off Low High Band	Off	L3	
PSP2 Hbk Value	Holdback value for PSP2	SP1 hi limit to SP1 lo limit	0	L3	
PSP3 Hbk Type	Holdback type for PSP3 These are deviation values between setpoint and process value	Off Low High Band	Off	L3	
PSP3 Hbk Value	Holdback value for PSP3	SP1 hi limit to SP1 lo limit	0	L3	

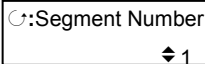
Hot Start PSP	Allows hot start to be applied to each PSP. See also 6.2.5.	None PSP1 PSP2 PSP3	None	L3. Only appears if Hot Start option has been enabled in config level.
Rate Units	Rate units for a Ramp Rate Programmer	Per Second Per Minute Per Hour		L3. Only displayed if the programmer is Ramp Rate
Prog Cycles	Sets the number of times the complete program is executed.	Continuous to 999	Continuous	L1
End Action	Defines the action in the end segment.  Dwell - the program will dwell indefinitely at the conditions set in the end segment, see 6.5.3.  Reset - the program will reset to the start conditions.	Dwell Reset		L1
Program Name	Allows a user defined name to be given to the program number	User string		L1

### 4.8.3. To Set Up Each Segment Of A Program

Do This	This Is The Display You Should See	Additional Notes
<p>1. From any display press  as many times as necessary until the 'PROGRAM EDIT' page header is displayed</p> <p>2. Press  if necessary to select <b>Segment Page</b></p>		<p>This page allows each segment to be edited.</p>
<p>3. Press . To select. <b>Edit Prg: 1</b>. This is the first parameter in the list</p> <p>4. Press  or  to choose the program number to be edited</p>	 <p>If the program exists, go to next parameter.</p> <p>If the program is new, confirm as instructed on the display</p> 	<p>The upper display shows the selected program number</p> <p>The middle display shows the current segment number</p> <p>After x secs or when  is pressed the display returns to that shown above</p>
<p>5. Press . To select. <b>Segment Number</b>.</p> <p>6. Press  or  to choose the segment to be edited</p>		<p>Up to 100 segments are available per program</p>
<p>7. Continue pressing  to access the further parameters in this page</p> <p>8. Continue pressing  or  to change the parameter value or state</p>		<p>Further parameters may be set up in the same way. These are listed together with an explanation of their function in the following table</p> <p style="text-align: center;">⇓</p>











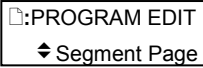

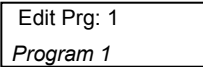



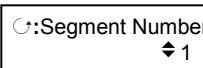



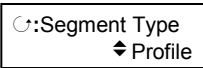

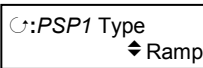

#### 4.8.4. PROGRAM EDIT(Segment Page) Parameters

Table Number: 4.8.4.		These parameters allow you to set up each segment in the program		PROGRAM EDIT (Segment Page)	
Parameter Name	Parameter Description	Value	Default	Access Level	
Edit Prg: 1 (to 20 or 50)	Selects the program number and name	1 to 20 (or 50)		L1	
Segment Number	Selects the segment number to be edited	1 to 100		L1	
Segment Type	Segment type Profile = a normal segment End Segment = the last segment in the program (press $\odot$ to confirm) Go Back = repeat part of prog. Not shown for segment 1.	Profile End Segment Go Back	Profile	L1	
PSP1 Type	Profile setpoint 1 type	Step Dwell Ramp		L1. Only shown for Ramp Rate programmer and not End	
PSP1 Target	Profile setpoint 1 target value	SP1 lo limit to SP1 hi limit	0	L1	
PSP1 Dwell Tm	Profile setpoint 1 dwell time	d : h : m : s		L1. Only shown for Ramp Rate programmer , a Dwell segment and not End	
PSP1 Rate	Profile setpoint 1 rate			L1. Only shown for Ramp Rate programmer , a ramp segment and not End	
PSP1 Hbk Type	Profile setpoint 1 holdback type	Off Low High Band	Off	L1. Only shown if holdback is configured per segment	

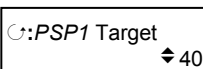
The above five parameters are repeated for <i>PSP2</i> and <i>PSP3</i> if they are configured				
Seg Duration	Duration for Time to Target programmer	d : h : m : s		L1. Does not appear for Ramp Rate Programmer or End segment
Wait Event	Wait if selected event is true	No wait Event A Event B Event C	No Wait	L1. Only shown if wait events configured
<i>Prog User Val 1</i>	Allows a programmer user value to be chosen. Only appears if Prog User Val 1 is configured	0 to 100	0	L1
<i>Prog User Val 2</i>	Allows a programmer user value to be chosen. Only appears if Prog User Val 2 is configured	0 to 100	0	L1
PID Set	Selects a set of PID values	PID Set 1 to PID Set 3		L3. Only shown if PID sets configured
Prog DO Values	Sets programmer event outputs on or off			L1. Only shown if Dout configured
Go Back Seg	Allows repeat segments to be set up within a profile. Go back defines the point in the program where the repeat segments are entered.	1 to number of segments		L1. Only shown if segment. type is Go Back
Go Back Cycles	Sets up the number of times the segments are repeated	1 to 999	1	L1. Only shown if segment. type is Go Back

## 4.9. EXAMPLES

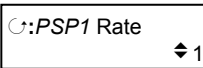
### 4.9.1. Program Data Entry Example in a Ramp Rate Programmer

Do This	The Display You Should See	Additional Notes
1. Select the <b>PROGRAM EDIT (Segment Page)</b>		
2. Press  to select <b>Edit Prg: 1</b>		The name of the program may have been customised
3. Press  or  to select the program to be edited		If this is a new program, the message <b>'Create Prog 1?'</b> will be displayed.
4. Press  to select <b>Segment Number</b>		Press  to confirm
5. Press  or  to select segment ( <b>1</b> )		
6. Press  to select <b>Segment Type</b>		Select:- <b>Profile</b> for a normal segment <b>End</b> for an end segment <b>GoBack</b> to repeat segments in the program
7. Press  or  to select <b>Profile</b>		
8. Press  to select <b>PSP1 Type 1</b>		Select:- <b>Ramp</b> to ramp the setpoint up or down <b>Dwell</b> to dwell <b>Step</b> to jump from the current setpoint to a new target
9. Press  or  to select <b>Ramp</b>		
10. Press  to select <b>PSP1 Target</b>		The setpoint will ramp to 40
11. Press  or  to set the setpoint which to ramp to		
12. Press  to select <b>PSP1 Rate</b>		The setpoint will ramp to 40 at the rate of 1 unit per sec, min or hour.
13. Press  or  to set the rate at which you wish to ramp to setpoint		If <i>PSP1</i> Type = Dwell This parameter is Dwell Tm  If <i>PSP1</i> Type = Step This parameter is omitted

If *PSP 2* is configured, steps 4 to 7 are repeated for *PSP2*.

If *PSP 3* is configured, steps 4 to 7 are again repeated for *PSP3*.

**If Wait Events are configured:-**

14. Press  to select **Wait Event**

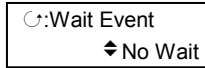

15. Press  or  to select the **wait event**



The choice are:-  
No Wait  
Event A  
Event B  
EventC

See also 6.6.4

**If Digital Event Outputs have been Configured:-**

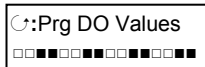
16. Press  to select **Prg DO Values**



17. Press  or  to select the digital output event to be On or Off

The first digital output will alternate between  and  indicating that it can be changed.



= Off  
 = On

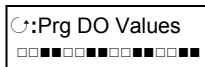

18. Press  to scroll through each event output in turn

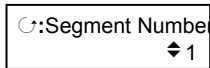

19. Press  to return to **Segment Number**



20. Press  or  to select the next required segment and repeat the above.













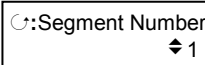





 **Tip:- To avoid scrolling through parameters you do not need to change, press  to return to the page header, then  to select Segment Number.**

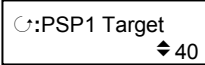

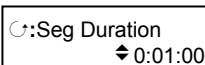

### 4.9.2. Prog Data Entry Example - Time to Target Programmer

This is the same as the previous procedure except that there are no Dwell, Rate or Step segments. They are all Time segments.

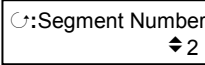









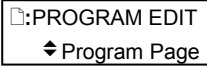



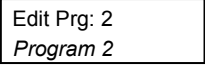

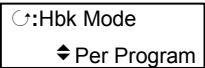

From the PROGRAM EDIT (segment Page) header:-

Do This	This Is The Display You Should See	Additional Notes
1. Press  to select <b>Segment Number</b>  2. Press  or  to select the segment		
3. Press  to select <b>Segment Type</b>  4. Press  or  to select <b>Profile</b>		The choices are :- Profile End Segment Go Back for segments after the first
5. Press  to select <b>PSP1 Target</b>  6. Press  or  to set the start level of the segment (if necessary)		For any segment $\neq 1$ , this value will normally be inherited from the Target level of the previous segment.
7. Press  to select <b>Seg Duration</b>  8. Press  or  to set the segment time		The setpoint will ramp to 40 at the rate of 1 unit per sec, min or hour  As in the previous example, if <i>PSP2</i> , <i>PSP3</i> , Wait Events and Event Outputs have been configured they will appear here.
9. Press  as many times as necessary to select <b>Segment Number</b> again  10. Press  or  to select the next segment (2) and repeat the above.		For a ramp <i>PSP1</i> - Seg No. 1 & <i>PSP1</i> - Seg No. 2 will be different values.  For a dwell <i>PSP1</i> Seg No. 1 & <i>PSP1</i> - Seg No. 2 will be the same value.

 **Tip:-** To avoid scrolling through parameters you do not need to change, press  to return to the page header, then  to select Segment Number.

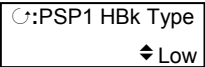



### 4.9.3. Holdback Example

To apply holdback (see also 6.2.8) to each segment of the program or to the overall program, follow this procedure:-

Do This	This Is The Display You Should See	Additional Notes
1. Select the <b>PROGRAM EDIT (Program Page)</b>	 <p>PROGRAM EDIT ◆ Program Page</p>	To select the page header which contains the holdback parameters
2. Press  until <b>Edit Prg:</b> is displayed  3. Press  or  to choose the required program	 <p>Edit Prg: 2 Program 2</p>	
4. Press  to display <b>HBK Mode</b>  5. Press  or  to choose Per Program (or Per Segment)	 <p>HBK Mode ◆ Per Program</p>	<p>Only appears if Holdback has been configured.</p> <p>If per program is chosen press  or  to choose the holdback type to be applied to the whole program.</p> <p>If per segment is chosen the parameter Holdback Type does not appear.</p>
6. Press  to select <b>PSP1 HBK Type</b>  7. Press  or  to choose Low, (or High or Band)	 <p>PSP1 HBK Type ◆ Low</p>	
8. Press  to select <b>PSP1 HBK Val</b>  9. Press  or  to choose the value which will hold the program	 <p>PSP1 HBK Val ◆ 5</p>	In this example holdback will occur in any segment of the program if the PV falls by more than 5 units below the SP.
10. Repeat the above steps for <i>PSP2</i> and <i>PSP3</i> if configured		If holdback per segment is chosen the holdback type can be chosen for each segment but the holdback value is the same for each segment.

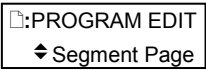





### 4.9.4. Wait Example

The wait feature prevents the programmer from proceeding to the next segment if an event is true (see also section 4.3.9.). It only applies to controllers which have been ‘wired’ for wait events in configuration level. If the controller has been configured for ‘Wait’, the operator can set up the conditions as follows:-

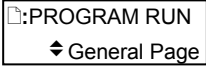
Do This	This Is The Display You Should See	Additional Notes				
1. Select the <b>PROGRAM EDIT</b> page header, and select <b>Segment Page</b>						
2. Press  until the parameter <b>Wait Event</b> is displayed  3. Press  or  to choose the event on which the programmer should wait eg <b>Event A</b>		This selects the <b>Wait Event</b> which will prevent the program from proceeding to the next segment. The choices are:- <table border="1" data-bbox="790 719 1041 1070"> <tbody> <tr> <td data-bbox="790 719 885 871">No Wait</td> <td data-bbox="885 719 1041 871">The wait condition does not apply to the selected segment</td> </tr> <tr> <td data-bbox="790 871 885 1070">Event A (B or C)</td> <td data-bbox="885 871 1041 1070">The selected segment will wait for event A (B or C) to become false before the program continues</td> </tr> </tbody> </table>	No Wait	The wait condition does not apply to the selected segment	Event A (B or C)	The selected segment will wait for event A (B or C) to become false before the program continues
No Wait	The wait condition does not apply to the selected segment					
Event A (B or C)	The selected segment will wait for event A (B or C) to become false before the program continues					

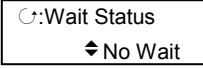

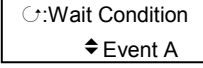

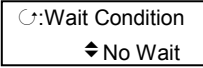

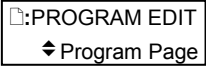

### 4.9.4.1. Wait Example - How Wait is Displayed in Run Mode

The status of the Wait condition is displayed in a running program as follows:-

Do This	This Is The Display You Should See	Additional Notes				
1. Select the <b>PROGRAM RUN (General Page)</b>						
2. Press  until the parameter <b>Wait Status</b> is displayed		The status is off if not waiting and true if waiting. The choices are:- <table border="1" data-bbox="726 525 982 679"> <tr> <td>No Wait</td> <td>The program is not waiting</td> </tr> <tr> <td>Event A (B or C)</td> <td>The program is waiting on event A (B or C)</td> </tr> </table>	No Wait	The program is not waiting	Event A (B or C)	The program is waiting on event A (B or C)
No Wait	The program is not waiting					
Event A (B or C)	The program is waiting on event A (B or C)					
3. Press  once - the parameter <b>Wait Condition</b> is displayed		The condition for the running segment is displayed. The choices are:- <table border="1" data-bbox="726 839 982 994"> <tr> <td>No Wait</td> <td>The program is not waiting</td> </tr> <tr> <td>Event A (B or C)</td> <td>The program is waiting on event A (B or C)</td> </tr> </table>	No Wait	The program is not waiting	Event A (B or C)	The program is waiting on event A (B or C)
No Wait	The program is not waiting					
Event A (B or C)	The program is waiting on event A (B or C)					
4. Press  or  to override the condition (No Wait), or to select a different event (Event A (B or C)).		The condition can be changed if the program is in <b>Hold</b>				

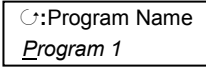
### 4.9.5. Program Names example

To produce a user defined program name:-

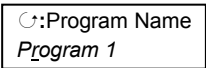
Do This	This Is The Display You Should See	Additional Notes
1. Select the <b>PROGRAM EDIT (Program Page)</b> page header	 <p>PROGRAM EDIT Program Page</p>	
2. Press  until <b>Program Name</b> is displayed  3. The first character alternates between _ and P  4. Press  or  to change the character to one of your choice	 <p>Program Name Program 1</p>	<p><i>Program 1</i> is the default name of a program.</p> <p>A full range of characters is available including capitals, numbers and common symbols</p>
5. Press  to select the next character  6. Press  or  to change the next character to one of your choice	 <p>Program Name Program 1</p>	

Repeat the above steps until the program name of your choice is displayed. A name of up to 16 characters can be entered.

This name will be displayed on every view which contains Program Name.



---

<b>5.</b>	<b>CHAPTER 5 ALARM OPERATION.....</b>	<b>2</b>
5.1.	<b>DEFINITION OF ALARMS AND EVENTS .....</b>	<b>2</b>
5.1.1.	Customisable Parameter Names .....	2
5.2.	<b>TYPES OF ALARM USED IN 2604 CONTROLLER.....</b>	<b>3</b>
5.2.1.	Grouped Alarms .....	4
5.3.	<b>HOW ALARMS ARE INDICATED.....</b>	<b>5</b>
5.3.1.	To Acknowledge an Alarm.....	5
5.3.2.	Alarm Delay Time .....	6
5.4.	<b>THE ALARM SUMMARY PAGE.....</b>	<b>7</b>
5.4.1.	Alarms (Summary) Parameters.....	8
5.5.	<b>ALARM ACKNOWLEDGEMENT .....</b>	<b>9</b>
5.6.	<b>TO SET ALARM TRIP LEVELS .....</b>	<b>11</b>
5.7.	<b>ALARM PARAMETERS .....</b>	<b>12</b>
5.7.1.	ALARMS ( <i>LPI</i> Page) Parameters.....	12
5.7.2.	ALARMS (PV Input Page) Parameters .....	13
5.7.3.	ALARMS (An Input Page) Parameters .....	13
5.7.4.	ALARMS (Module 1 Page) Parameters .....	14
5.7.5.	ALARMS (User 1 Page) Parameters .....	14

## 5. Chapter 5 ALARM OPERATION

### 5.1. DEFINITION OF ALARMS AND EVENTS

**Alarms** are used to alert an operator when a pre-set level has been exceeded. They are normally used to switch an output – usually a relay – to provide external actions to the process.

**Soft Alarms** are indication only and do not operate an output.

**Events** are generally defined as conditions, which occur as part of the operation of the plant. They do not require operator intervention and, therefore, do not cause an alarm message to be displayed. They can be attached to operate an output (relay) in the same way as an alarm.

#### 5.1.1. Customisable Parameter Names

**Throughout this chapter parameter names shown in *italics* are customisable by the user when in configuration access level. The name of the parameter may vary, therefore, from instrument to instrument.**

Typical customisable parameter names are:

- Alarm names
- Loop names
- Module and input names
- Custom units
- Promoted parameters



## 5.2. TYPES OF ALARM USED IN 2604 CONTROLLER

This section shows graphically the operation of different types of alarm used in the controller. The graphs show changes in PV plotted against time.

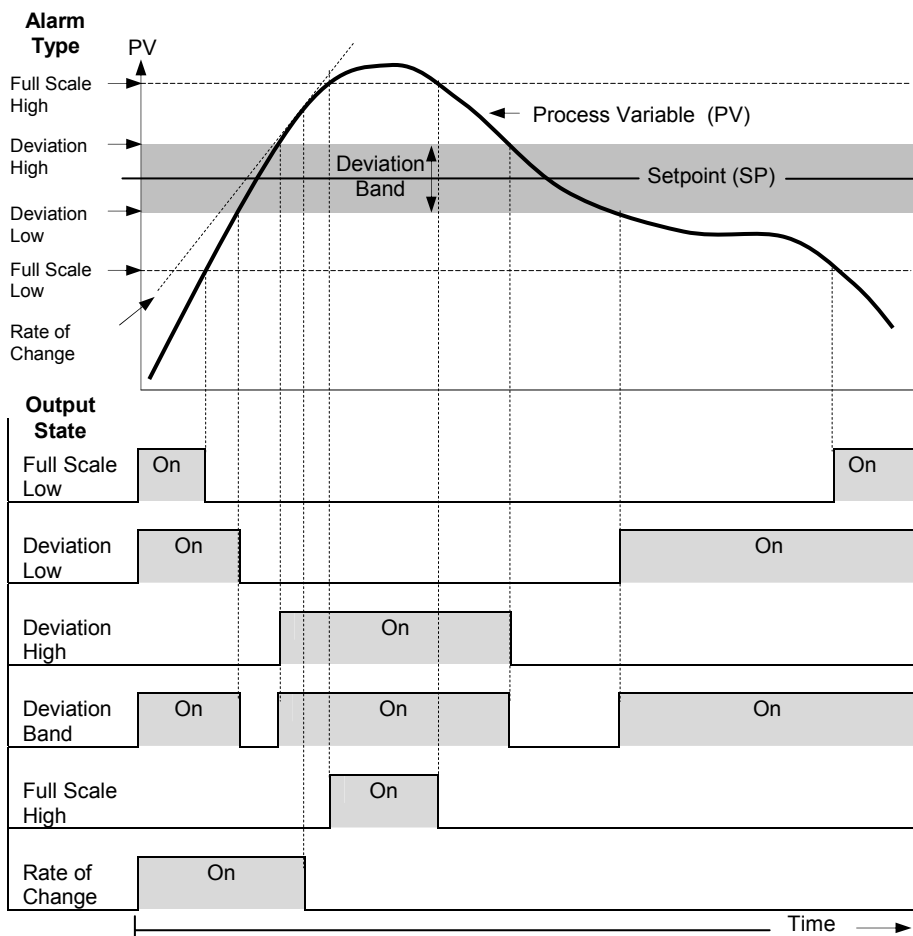

Figure 5-1: Types of Alarm

**Rate of change alarms** detect if the rate of change in PV, set as units per minute or per second, exceeds the setpoint value. An alarm setpoint set + will detect positive rates of change. An alarm setpoint set - will detect negative rates of change. Therefore, if it is required to measure the rate of change in both directions then two alarms must have been configured. Since rate of change alarms are calculated over a period of time a small delay may be apparent before the alarm is indicated. This is generally only noticeable if the PV changes very quickly.

**Deviation Alarms.** The setpoint used for deviation alarms is normally derived as a remote input from another device - for example, a temperature controller. The setpoint can also be internally set within the controller - in this case called the local setpoint value.

**Blocking Alarms** only occur after the start up phase when the alarm has first entered a safe state. The alarm is only indicated the next time it is active. It is used, for example, to ignore start up conditions which are not representative of running conditions.

**Hysteresis** is the difference between the point at which the alarm switches ON and the point at which it switches OFF.

It is used to prevent relay chatter.

**Delay** a settable time between an alarm occurring and it being displayed on the indicator

**Latching Alarms** The alarm is indicated until it is acknowledged by the user.

Acknowledgement of an alarm can be through the controller front buttons, from an external source using a digital input to the controller or through digital communications.

There are two ways that the alarm can be acknowledged:

1. **Automatic Reset.** The alarm continues to be active until both the alarm condition is removed AND the alarm is acknowledged. The acknowledgement can occur **BEFORE** the alarm condition is removed.
2. **Manual Reset.** The alarm continues to be active until both the alarm condition is removed AND the alarm is acknowledged. The acknowledgement can only occur **AFTER** the alarm condition is removed.

### 5.2.1. Grouped Alarms

Alarms can be associated with different aspects of the process. They are grouped in accordance with the functions they perform as follows:

Loop Alarms	Alarms associated with each control loop. Examples are: High, Low, Deviation and Rate of Change. Two alarms are available for each loop. On a new controller these are the only alarms which are configured - those listed below must be enabled in configuration level, see 2604 Engineering Handbook HA026761.
PV Input Alarms	Alarms which operate on the PV input. Examples are: High and Low. Two alarms are available with this input.
Analogue Input Alarms	Alarms which operate on the analogue input. Examples are: High and Low. Two alarms are available with this input.
Module Alarms	Alarms which operate on each plug in module. These can be input or output alarms depending upon the function of the module fitted. These alarms are associated with modules 1, 3, 4, 5, & 6, since module 2 is reserved as an extra memory module
User Alarms	Eight undedicated alarms which can be wired to any variable.

### 5.3. HOW ALARMS ARE INDICATED

When an alarm occurs the red ALM beacon in the middle display will flash. This will be accompanied by a message on the lower display which will indicate the source and the type of alarm. The format of this alarm message is:

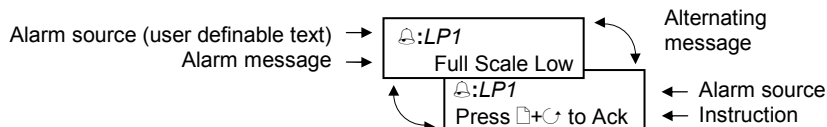

If a relay has been connected to the output of the alarm the relay it will operate to allow an external beacon or audible device to be activated.

Events will not cause either a message or the beacon to be illuminated.

#### 5.3.1. To Acknowledge an Alarm

Press [F1]+[C] as instructed.

The action which follows depends upon the type of alarm configured.

If the alarm is non latching	Any relay connected to the alarm output will be reset The red alarm beacon will illuminate permanently if the alarm condition still exists The red alarm beacon will extinguish as soon as the alarm condition no longer exists
Alarm is latching – ‘Auto’	Any relay connected to the alarm output will remain set if the alarm condition still exists The red alarm beacon will illuminate permanently if the alarm condition still exists As soon as the alarm condition is no longer present the alarm beacon will extinguish and any relay will be reset
Alarm is latching – ‘Manual’	Any relay connected to the alarm output will remain set if the alarm condition still exists The red alarm beacon will illuminate permanently if the alarm condition still exists The alarm indication and any relay connected to it must now be reset. This may be done as described in section 5.4 ‘The Alarm Summary Page’, or by choosing the appropriate Alarm Page, select ‘Alarm Ack’ - set to ‘Yes’, Press [C] as instructed.

This section describes the usual method to acknowledge an alarm. Section 5.5 describes alternative ways.

### 5.3.2. Alarm Delay Time

A delay time may have been set for each alarm between the occurrence of the alarm and the indication of the alarm in the controller. This is useful to prevent spurious alarms from being indicated in some noisy or rapidly changing processes.









To set delay time the controller must be placed in Configuration level. This is described in the 2604 Engineering Handbook Part No HA026761.

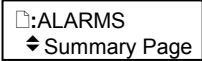

If you notice a delay between an alarm occurring and it being indicated by the controller then a delay may have been set in configuration level.

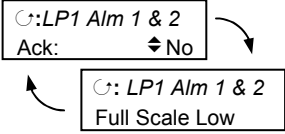
## 5.4. THE ALARM SUMMARY PAGE

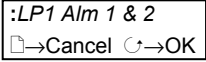
The status of alarms is displayed in the Alarm Summary page. To inspect the status:



Do This	This Is The Display You Should See	Additional Notes
1. From any display press  as many times as necessary until the 'Alarms' page (Summary) header is displayed		To access the Alarm Summary page header.
2. Press  The first parameter displayed is 'New Alarm'		No There are no new alarms Yes One or more new alarms have occurred since the last acknowledgement
3. Press  to see the alarm		Further pages only appear if the alarms have been configured. The first of these pages is 'LP1 Alm 1-2' This shows the name of the alarm in the upper readout The lower readout alternates between the alarm type and an invitation to acknowledge Note: Customised Parameter name in <i>italics</i>
4. Press  or  to acknowledge - 'Yes'		
5. Press  as instructed		A full list of possible alarm parameters in this page is given in the following table  



### 5.4.1. Alarms (Summary) Parameters

Table Number: 5.4.1		These parameters indicate alarm status		ALARMS (Summary Page)	
Parameter Name	Parameter Description	Value	Default	Access Level	
New Alarm	Only available over digital communications to flag that a new alarm has occurred	No Yes		L1 R/O	
<i>LP1 Ack</i>	Status and acknowledge loop 1 alarms	No Yes		L1	
<i>LP2 Ack</i>	Status and acknowledge loop 2 alarms	No Yes		L1	
<i>LP3 Ack</i>	Status and acknowledge loop 3 alarms	No Yes		L1	
<i>PV Input Ack</i>	Status and acknowledge PV input alarms	No Yes		L1	
<i>An Input Ack</i>	Status and acknowledge analogue input alarms	No Yes		L1	
<i>Module 1 Ack</i>	Status and acknowledge module 1 alarms	No Yes		L1	
<i>Module 3 Ack</i>	Status and acknowledge module 3 alarms	No Yes		L1	
<i>Module 4 Ack</i>	Status and acknowledge module 4 alarms	No Yes		L1	
<i>Module 5 Ack</i>	Status and acknowledge module 5 alarms	No Yes		L1	
<i>Module 6 Ack</i>	Status and acknowledge module 6 alarms	No Yes		L1	
<i>User 1 Ack</i>	Status and acknowledge User 1 alarm	No Yes		L1	
to	to				
<i>User 8 Ack</i>	Status and acknowledge User 8 alarm	No Yes		L1	
Ack All	Acknowledges all alarms	No Yes		L1	

## 5.5. ALARM ACKNOWLEDGEMENT

A new alarm can be acknowledged in five ways:

1. By pressing  and  simultaneously
2. Through the alarms 'Summary' page
3. Through the 'Alarms' page
4. From an external source, such as a pushbutton, connected to a suitably configured digital input
5. Through digital communications

The message will remain on the screen and the alarm symbol, , will continue to flash until the alarm is acknowledged - you are prompted to do this by pressing  and  simultaneously. The symbol will stop flashing and remain illuminated until all alarm conditions are removed. If a further alarm occurs the symbol will start flashing again and a new alarm message will pop up.

The message displayed indicates the source of the alarm and may be customised to the users terminology. The source will inherit the name of the channel or the loop or the user alarm name.

The operation of the alarm acknowledgement depends whether the alarm is non-latching or latching, auto or manual reset. This is shown in the following tables:-



### Non Latched Alarms

Alarm Condition	Acknowledge	Symbol 	Message	Ext relay (if fitted)
ON	No	Flashing	Alarm message	On
Off	No	Off	Former display	Off

Alarm Condition	Acknowledge	Symbol 	Alarm message	Ext relay (if fitted)
ON	No	Flashing	Alarm message	On
On	Yes	Steady	Former display	Off
Off		Off	Former message	Off

### Latched Alarm - Auto

Alarm Condition	Acknowledge	Symbol 	Message	Ext relay (if fitted)
ON	No	Flashing	Alarm message	On
Off	No	Flashing	Alarm message	On
Off	Yes			

Alarm Condition	Acknowledge	Symbol 	Message	Ext relay (if fitted)
ON	No	Flashing	Alarm message	On
ON	Yes	Steady	 :Access Level	Off
Off	-	Off	Normal display	Off

**Latched Alarm - Manual**









<b>Alarm Condition</b>	<b>Acknowledge</b>	<b>Symbol</b> 	<b>Message</b>	<b>Ext relay (if fitted)</b>
ON	No	Flashing	Alarm message	On
Off	No	Flashing	Alarm message	On
Off	Yes	Off	Access Level	Off

<b>Alarm Condition</b>	<b>Acknowledge</b>	<b>Symbol</b> 	<b>Message</b>	<b>Ext relay (if fitted)</b>
ON	No	Flashing	Alarm message	On
ON	Yes	Steady	Former display	Off
Off	-	Steady	Former display	Off
Off	To acknowledge see below	Off	Former display	Off

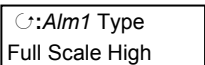

## 5.6. TO SET ALARM TRIP LEVELS

The alarm trip level (setpoint) is available in access level 1 and is adjusted by accessing the page header for the chosen alarm. The following example adjusts these parameters for Alarm 1/Loop 1:

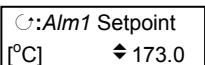
Do This	This Is The Display You Should See	Additional Notes
1. From any display press  as many times as necessary to access the 'ALARMS' menu  2. Press  or  to select the source of the alarm, in this example 'LP1'		Text 'LP1' is user definable.  The alarm type must have been selected in config level, otherwise the alarm parameters will not be available
3. Press  to display the Alarm Type		Alm1 Type is read only. The alarm type is set in configuration level
4. Press  again to display the 'Alm1 setpoint'  5. Press  or  to adjust the value		This example sets the alarm trip level to 173 °C.  Other units will be shown if they have been configured.

## 5.7. ALARM PARAMETERS

The parameter tables listed in this section are only displayed if an alarm has been configured for the particular loop, input or module.

### 5.7.1. ALARMS (LP1 Page) Parameters

Table Number: 5.7.1.		These parameters set up the Loop 1 alarms		ALARMS (LP1) Page
Parameter Name	Parameter Description	Value	Default	Access Level
Alm1 Type	Alarm 1 Type	Off Full Scale Low Full Scale High Deviation Band Deviation High Deviation Low Rate of Change If True If False Goes True Goes False If Changed		R/O
LP1 Ack	Acknowledges alarms on loop 1	No Yes		L1
Alm1 Setpoint	Alarm 1 Setpoint	Controller range		L1
Alm1 Output	Alarm 1 output	Off On	Off	R/O
Alm2 Type	Alarm 2 Type	As Alm1 Type		R/O
Alm2 Setpoint	Alarm 2 Setpoint	Controller range		L1
Alm2 Output	Alarm 2 output	Off On	Off	R/O

The above table is repeated for LP2 and LP3 if these control loops have been configured.

### 5.7.2. ALARMS (PV Input Page) Parameters

Table Number: 5.7.2.		These parameters set up the alarms associated with the PV input signal.		ALARMS (PV Input Page)	
Parameter Name	Parameter Description	Value	Default	Access Level	
PV Alarm Ack	Alarm acknowledge for PV input	No Yes	No	L1	
FS Hi Setpoint	Full Scale High Alarm (1) Setpoint	Controller range		L1	
FS Hi Output	Full Scale High alarm (1) output	Off On	Off	R/O	
FS Lo Setpoint	Full Scale Low Alarm (2) Setpoint	Controller range		L1	
FS Lo Output	Full Scale Low alarm (2) output	Off On	Off	R/O	

### 5.7.3. ALARMS (An Input Page) Parameters

Table Number: 5.7.3.		These parameters set up the alarms associated with the analogue input signal.		ALARMS (An Input Page)	
Parameter Name	Parameter Description	Value	Default	Access Level	
An Alm Ack	Group alarm acknowledge for analogue input	No Yes	No	L1	
FS Hi Setpoint	Full Scale High alarm (1) Setpoint	Controller range		L1	
FS Hi Output	Full Scale High alarm (1) output	Off On	Off	R/O	
FS Lo Setpoint	Full Scale Low Alarm (2) Setpoint	Controller range		L1	
FS Lo Output	Full Scale Low alarm (2) output	Off On	Off	R/O	

### 5.7.4. ALARMS (Module 1 Page) Parameters

Table Number: 5.7.4.		These parameters set up the alarms associated with module 1.		ALARMS (Module 1 Page)	
Parameter Name	Parameter Description	Value	Default	Access Level	
Module 1 Ack	Group alarm acknowledge for module 1	No Yes	No	L1	
FS Hi Setpoint	Full Scale High alarm (1) Setpoint	Controller range		L1	
FS Hi Output	Full Scale High alarm (1) output	Off On	Off	R/O	
FS Lo Setpoint	Full Scale Low Alarm (3) Setpoint	Controller range		L1	
FS Lo Output	Full Scale Low alarm (3) output	Off On	Off	R/O	

The above table is repeated for:

Module 3

Module 4

Module 5

Module 6

### 5.7.5. ALARMS (User 1 Page) Parameters

Table Number: 5.7.5.		These parameters set up user defined alarms.		ALARMS (User 1 Page)	
Parameter Name	Parameter Description	Value	Default	Access Level	
Alm1 Type	Alarm 1 Type	Same as 5.7.1.		R/O	
User 1 Ack	Group alarm acknowledge for user alarm 1	No Yes	No	L1	
Setpoint	Alarm 1 Setpoint	Controller range		L1	
Output	Alarm 1 output	Off On	Off	R/O at L1	

The above table is repeated for:

User alarm 2

User alarm 3

User alarm 4

User alarm 5

User alarm 6

User alarm 7

User alarm 8

**A. APPENDIX A ORDER CODE ..... 2**  
**A.1. HARDWARE CODE ..... 2**  
**A.2. CONFIGURATION CODING (OPTIONAL) ..... 3**  
**A.3. QUICK START CODE EXAMPLE: ..... 4**

# A. Appendix A Order Code

## A.1. HARDWARE CODE

The 2604 has a modular hardware construction, which accepts up to six plug-in modules and two comms modules. Eight digital IO and a relay form part of the fixed hardware build.

1	2	3	4	5	6	7	8	9	10	11	12	13	14
---	---	---	---	---	---	---	---	---	----	----	----	----	----

<b>1 Controller Type</b> 2604 Standard 2604f Profibus		<b>5 - 9 I/O Slots 1 3 4 5 6</b> XX None Fitted R4 Change Over Relay R2 2 Pin Relay RR Dual Relay T2 Triac TT Dual Triac D4 DC Control D6 DC Retransmission DP Probe inputs (slots 3 & 6) AM Analogue input (not slot 5) PV PV Input(slots 3 & 6 only) TL Triple Logic Input TK Triple Contact Input TP Triple Logic Output MS 24Vdc Transmitter PSU VU Potentiometer Input G3 5Vdc transducer PSU G5 10Vdc transducer PSU LO Isolated single logic OP DO Dual 4-20mA OP/24Vdc PSU (slots 1,4,5 only) HR Hi resolution DC retrans & 24Vdc PSU (slots 1,4,5 only) <sup>(6)</sup>				<b>10 - Comms H</b> XX None Fitted A2 232 Modbus Y2 2 wire EIA-485 F2 4 wire EIA-485 AE 232 Bisynch <sup>(5)</sup> YE 2 Wire 485 Bisynch <sup>(5)</sup> FE 4 Wire 485 Bisynch <sup>(5)</sup> PB Profibus DN DeviceNet	
<b>2 Supply Voltage</b> VH 85-264Vac VL 20-29Vac/dc						<b>11 Comms J</b> XX None Fitted A2 232 Modbus Y2 2 wire EIA-485 F2 4 wire EIA-485 M1 232 Master M2 2-wire 485 Master M3 4-wire 485 Master	
<b>3 Loops/Programs</b> First Digit 1__ One Loop 2__ Two Loop 3__ Three Loop Second Digit __XX No Programs __2 20 Programs <sup>(1)</sup> __5 50 Programs Third Digit __XX No Programs __1 1 Profile __2 2 Profile __3 3 Profile						<b>12 Manual</b> ENG English FRA French GER German NED Dutch SPA Spain SWE Sweden ITA Italian	
<b>4 Application</b> XX Standard ZC Zirconia						<b>13 Toolkit Blocks</b> XX Standard U1 Toolkit level 1 <sup>(2)</sup> U2 Toolkit level 2 <sup>(3)</sup>	
						<b>14 Config Tools</b> XX None IT iTools	

### Hardware notes:

- Basic controller/programmer includes 8 digital registers, 4 timers, 4 totalisers
- Toolkit 1 includes 16 analogue, 16 digital, pattern generator, digital programmer, analogue switch & 4 user values
- Toolkit 2 includes Toolkit 1 plus extra 8 analogue, 16 digital operations and 8 user values
- Dual analogue input suitable for carbon probes.(inputs not isolated from each other)
- EI-Bisynch includes only a subset of parameters
- The HR module has one high resolution DC output and one 24Vdc power supply

### Hardware Code Example

**2604/VH/323/XX/RR/PV/D4/TP/PV/XX/A2/XX/ENG/U1/IT**

Three loop controller with capability to store 20 three profile programs. Supply voltage 85 - 264 Vac.  
 Modules: 2 x PV input, 1 x Dual relay, 1 x DC control, 1 x Triple logic output, EIA-232 Comms.  
 16 analogue and 32 digital operations and iTools supplied with controller.

## A.2. CONFIGURATION CODING (OPTIONAL)

The controller supplied in accordance with the hardware code on the previous page requires to be configured. Configuration is carried out using iTools. Alternatively, for simple applications the controller may be supplied pre-configured using the following code:-

1	2	3	4	5	6	7	8	9	10	11	12												
<b>1 - 3 Loop function</b> First Digit XXXX None S___ Standard PID C___ Cascade R___ Ratio O___ Override <sup>(7)</sup> Other Digits _PID PID control _ONF On/Off control _PIF PID/OnOff control _VP1 VP w/o feedback _VP2 VP with feedback			<b>4 - 6 PV Inputs</b> X None J J Thermocouple K K Thermocouple T T Thermocouple L L Thermocouple N N Thermocouple R R Thermocouple S S Thermocouple B B Thermocouple P P Thermocouple C C Thermocouple Z RTD/PT100 A 4-20mA linear Y 0-20mA linear V 0-10Vdc linear W 0-5Vdc linear G 1-5Vdc linear <b>Custom (Replace C)</b> Q Custom curve D D Thermocouple E E Thermocouple 1 Ni/Ni18%Mo 2 Pt20%Rh/Pt40%Rh 3 W/W26%Re(Eng) 4 W/W26%Re(Hos) 5 W5%Re/W26%Re(Eng) 6 W5%Re/W26%Re(Hos) 7 Pt10%Rh/Pt40%Rh 8 Exergen K80 IR Pyro			<b>7 Analogue Input</b> XXX None P2_ PV Loop 2 P3_ PV Loop 3 S1_ SP Loop 1 S2_ SP Loop 2 S3_ SP Loop 3 A1_ Aux PV Loop 1 A2_ Aux PV Loop 2 A3_ Aux PV Loop 3 L1_ Ratio lead PV Loop 1 L2_ Ratio lead PV Loop 2 L3_ Ratio lead PV Loop 3 <b>Input range</b> Select third digit from table 1 <table border="1"> <thead> <tr> <th colspan="2">Table 1</th> </tr> </thead> <tbody> <tr> <td>A</td> <td>4-20mA linear</td> </tr> <tr> <td>Y</td> <td>0-20mA linear</td> </tr> <tr> <td>V</td> <td>0-10Vdc linear</td> </tr> <tr> <td>W</td> <td>0-5Vdc linear</td> </tr> <tr> <td>G</td> <td>1-5Vdc linear</td> </tr> </tbody> </table>			Table 1		A	4-20mA linear	Y	0-20mA linear	V	0-10Vdc linear	W	0-5Vdc linear	G	1-5Vdc linear	<b>8 - 12 Slot function</b> <b>Loop number</b> XXX Unconfigured 1_ Loop No 1 2_ Loop No 2 3_ Loop No 3 <b>Single relay or triac</b> _HX Heat _CX Cool <b>Dual relay or triac</b> _HC PID Heat & Cool _VH VP Heat _VC VP Cool _AA FSH & FSH _AB FSH & FSL _AC DH & DL _AD FSH & DH _AE FSL & DL _AF FSH & FSL _AG FSH & DB _AH FSL & DB _AJ DB & DB HHX Heat O/P Ips 1 & 2 CCX Cool O/P Ips 1 & 2 P12 Prog events 1 & 2 P34 Prog events 3 & 4 P56 Prog events 5 & 6 P78 Prog events 7 & 8 <b>Triple logic output</b> _HX Ch1 Heat _CX Ch1 Cool _HC Ch1 Heat, Ch2 Cool HHX Heat O/P Ips 1 & 2 HHH Heat O/P Ips 1,2 & 3 <b>Single DC outputs</b> _H PID Heat _C PID Cool _T PV Retransmission _S SP Retransmission For output range select third digit from table 1 <b>Precision PV input</b> _PV PV input Module _PA Aux PV Input <sup>(8)</sup> _PL Ratio lead input		
Table 1																							
A	4-20mA linear																						
Y	0-20mA linear																						
V	0-10Vdc linear																						
W	0-5Vdc linear																						
G	1-5Vdc linear																						
			<b>Dual 4-20mA/24Vdc Tx OP</b> HHX Heat OP Lps 1 & 2 _HC Heat Cool _HT Ch 1 Heat, Ch 2 Tx TTX Both chs Txmtr <b>Changeover Relay</b> _HX Heat _CX Cool <b>Potentiometer input</b> _VF VP Heat Feedback _VZ VP Cool Feedback _RS Remote SP <b>Analogue Input *</b> _R_ Setpoint <b>Aux &amp; lead PV inputs *</b> _L_ Ratio lead input _B_ Aux PV input * For input range select third digit from table 1 <b>High Res DC Output</b> -TA 4-20mA PV retran -TV 0-10V PV retran -SA 4-20mA SP retran -SV 0-10V SP retran																				

---

**General Notes**

1. Loop 1 PV defaults to main input on microboard. Loop 2 and 3 PV inputs must be fitted in I/O slots 3 or 6 or be assigned to the analogue input.
2. This alarm configuration refers to loop alarms only. One selection per loop is allowed. Additional alarms are available for the user to configure.
3. Thermocouple and RTD inputs assume sensor min and max values with no decimal point.
4. Linear inputs are ranged 0-100%, no decimal point.
5. Temperature inputs will be C unless ordered by USA where F will be supplied.
6. Remote setpoints assume loop min & max ranges.
7. VP1 or VP2 not available with override function.
8. For cascade and override inputs only.
9. HR module should be used in feedback mode.

**A.3. QUICK START CODE EXAMPLE:****SVP1/SPID/SPID/K/Z/A/S1A/1VH/2PV/2HV/3HC/3PV**

This code configures the hardware specified on page A2 to be:

Loop1: Valve position control, Type K input, Ch1 VP output in slot 1, 4-20mA remote setpoint input.

Loop 2: PID control, RTD input in slot 3, 0-10Vdc Ch1 output in slot 4.

Loop 3: PID control, 4-20mA input in slot 6, Logic Ch1/Ch2 output in slot 5.



<b>B. APPENDIX B SAFETY AND EMC INFORMATION .....</b>	<b>2</b>
<b>B.1. SAFETY .....</b>	<b>2</b>
B.1.1. Electromagnetic compatibility .....	2
<b>B.2. SERVICE AND REPAIR .....</b>	<b>2</b>
B.2.1. Electrostatic discharge precautions .....	2
B.2.2. Cleaning .....	2
<b>B.3. INSTALLATION SAFETY REQUIREMENTS .....</b>	<b>3</b>
B.3.1. Safety Symbols.....	3
B.3.2. Personnel.....	3
B.3.3. Enclosure of live parts.....	3
B.3.4. Isolation .....	3
B.3.5. Wiring .....	4
B.3.6. Power Isolation .....	4
B.3.7. Earth leakage current .....	4
B.3.8. Overcurrent protection .....	5
B.3.9. Voltage rating.....	5
B.3.10. Conductive pollution.....	5
B.3.11. Over-temperature protection .....	6
B.3.12. Grounding of the temperature sensor shield.....	6
<b>B.4. INSTALLATION REQUIREMENTS FOR EMC .....</b>	<b>6</b>
B.4.1. Routing of wires.....	6

## **B. Appendix B Safety and EMC Information**

This controller is manufactured in the UK by Eurotherm Controls Ltd.

Please read this section carefully before installing the controller

This controller is intended for industrial temperature and process control applications when it will meet the requirements of the European Directives on Safety and EMC. Use in other applications, or failure to observe the installation instructions of this handbook may impair the safety or EMC protection provided by the controller. It is the responsibility of the installer to ensure the safety and EMC of any particular installation.

### **B.1. SAFETY**

This controller complies with the European Low Voltage Directive 73/23/EEC, amended by 93/68/EEC, by the application of the safety standard EN 61010.

#### **B.1.1. Electromagnetic compatibility**

This controller conforms with the essential protection requirements of the EMC Directive 89/336/EEC, amended by 93/68/EEC, by the application of a Technical Construction File. This instrument satisfies the general requirements for heavy/light industrial and residential/commercial environments as described by EN 50081-1 and EN 50082-1. For more information on product compliance refer to the Technical Construction File.

### **B.2. SERVICE AND REPAIR**

This controller has no user serviceable parts. Contact your supplier for repair.

#### **Caution: Charged capacitors**

Before removing an instrument from its sleeve, disconnect the supply and wait at least two minutes to allow capacitors to discharge. Failure to observe this precaution will expose capacitors that may be charged with hazardous voltages. In any case, avoid touching the exposed electronics of an instrument when withdrawing it from the sleeve.

#### **B.2.1. Electrostatic discharge precautions**

When the controller is removed from its sleeve, some of the exposed electronic components are vulnerable to damage by electrostatic discharge from someone handling the controller. To avoid this, before handling the unplugged controller discharge yourself to ground.

#### **B.2.2. Cleaning**

Do not use water or water based products to clean labels or they will become illegible. Isopropyl alcohol may be used to clean labels. A mild soap solution may be used to clean other exterior surfaces of the product.

## B.3. INSTALLATION SAFETY REQUIREMENTS

### B.3.1. Safety Symbols

Various symbols are used on the instrument, they have the following meaning:



Caution, (refer to the accompanying documents)



Functional earth (ground) terminal

The functional earth connection is not required for safety purposes but to ground RFI filters.

### B.3.2. Personnel

Installation must only be carried out by qualified personnel.

### B.3.3. Enclosure of live parts

To prevent hands or metal tools touching parts that may be electrically live, the controller must be installed in an enclosure.

### B.3.4. Isolation

The fixed digital I/O and analogue input are not isolated. The PV Input and all plug in modules are fully isolated. This is shown in Figure B-1.

The Analogue Input is a self biased differential input suitable for either grounded or floating transducers of low output impedance generating signal in the range of +/-10V or +/-20mA (with a burden resistor of 100 Ohms across + and - terminals).

This input is neither isolated from the instrument ground (which can be earthed via fixed I/O ports) nor isolated from the instrument earth terminal, therefore, under no circumstances should mains potentials be applied to any of its inputs.

In order for the Input to operate safely the common voltage at the inputs measured with respect to instrument ground should not exceed +/-120Vdc or  $a_{c_{rms}}$ . For actively enhanced common mode rejection (i.e. operation within the spec.) this voltage should be limited to +/-40Vdc.

Floating transducers will automatically be biased to +2.5V with respect to instrument ground upon connection.

Note: All the other I/Os are fully isolated from the instrument ground and each other.

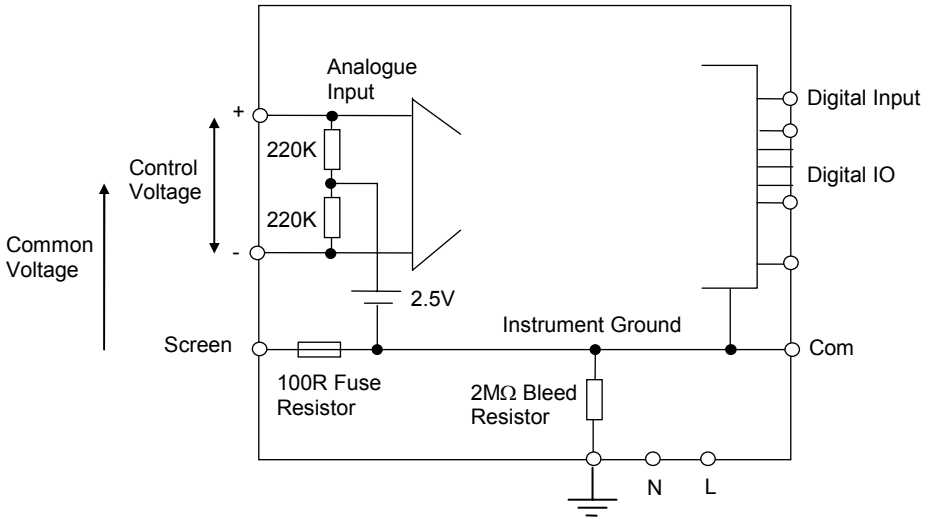

**Figure B-1: Analogue Input and Fixed Digital I/O Equivalent Circuit**

**B.3.5. Wiring**

It is important to connect the controller in accordance with the wiring data given in this handbook. Take particular care not to connect AC supplies to the low voltage sensor input or other low level inputs and outputs. Only use copper conductors for connections (except thermocouple inputs) and ensure that the wiring of installations comply with all local wiring regulations. For example in the in the UK use the latest version of the IEE wiring regulations, (BS7671). In the USA use NEC Class 1 wiring methods.

**B.3.6. Power Isolation**

The installation must include a power isolating switch or circuit breaker. This device should be in close proximity to the controller, within easy reach of the operator and marked as the disconnecting device for the instrument.

**B.3.7. Earth leakage current**

Due to RFI Filtering there is an earth leakage current of less than 0.5mA. This may affect the design of an installation of multiple controllers protected by Residual Current Device, (RCD) or Ground Fault Detector, (GFD) type circuit breakers.

### **B.3.8. Overcurrent protection**

To protect the internal PCB tracking within the controller against excess currents, the AC power supply to the controller and power outputs must be wired through the fuse or circuit breaker specified in the technical specification.

### **B.3.9. Voltage rating**

The maximum continuous voltage applied between any of the following terminals must not exceed 264Vac:

- line or neutral to any other connection;
- relay or triac output to logic, dc or sensor connections;
- any connection to ground.

The controller should not be wired to a three phase supply with an unearthed star connection. Under fault conditions such a supply could rise above 264Vac with respect to ground and the product would not be safe.

Voltage transients across the power supply connections, and between the power supply and ground, must not exceed 2.5kV. Where occasional voltage transients over 2.5kV are expected or measured, the power installation to both the instrument supply and load circuits should include a transient limiting device.

These units will typically include gas discharge tubes and metal oxide varistors that limit and control voltage transients on the supply line due to lightning strikes or inductive load switching. Devices are available in a range of energy ratings and should be selected to suit conditions at the installation.

### **B.3.10. Conductive pollution**

Electrically conductive pollution must be excluded from the cabinet in which the controller is mounted. For example, carbon dust is a form of electrically conductive pollution. To secure a suitable atmosphere in conditions of conductive pollution, fit an air filter to the air intake of the cabinet. Where condensation is likely, for example at low temperatures, include a thermostatically controlled heater in the cabinet.

### **B.3.11. Over-temperature protection**

When designing any control system it is essential to consider what will happen if any part of the system should fail. In temperature control applications the primary danger is that the heating will remain constantly on. Apart from spoiling the product, this could damage any process machinery being controlled, or even cause a fire.

Reasons why the heating might remain constantly on include:

- the temperature sensor becoming detached from the process;
- thermocouple wiring becoming short circuit;
- the controller failing with its heating output constantly on;
- an external valve or contactor sticking in the heating condition;
- the controller setpoint set too high.

Where damage or injury is possible, we recommend fitting a separate over-temperature protection unit, with an independent temperature sensor, which will isolate the heating circuit. Please note that the alarm relays within the controller will not give protection under all failure conditions.

### **B.3.12. Grounding of the temperature sensor shield**

In some installations it is common practice to replace the temperature sensor while the controller is still powered up. Under these conditions, as additional protection against electric shock, we recommend that the shield of the temperature sensor is grounded. Do not rely on grounding through the framework of the machine.

## **B.4. INSTALLATION REQUIREMENTS FOR EMC**

To ensure compliance with the European EMC directive certain installation precautions are necessary as follows:

- For general guidance refer to EMC Installation Guide, HA025464.
- When using relay or triac outputs it may be necessary to fit a filter suitable for suppressing the emissions. The filter requirements will depend on the type of load. For typical applications we recommend Schaffner FN321 or FN612.
- If the unit is used in a portable enclosure which is plugged into a standard power socket, then it is likely that compliance to the commercial and light industrial emissions standard is required. In this case to meet the conducted emissions requirement, a suitable mains filter should be installed. We recommend Schaffner types FN321 and FN612.

### **B.4.1. Routing of wires**

To minimise the pick-up of electrical noise, the wiring for low voltage dc and particularly the sensor input should be routed away from high-current power cables. Where it is impractical to do this, use shielded cables with the shield grounded at both ends.

<b>C.</b>	<b>APPENDIX C TECHNICAL SPECIFICATION .....</b>	<b>2</b>
C.1.	ALL ANALOGUE, DUAL AND PV INPUTS.....	2
C.2.	PRECISION PV INPUT / MODULE.....	3
C.3.	DUAL (PROBE) INPUT MODULE.....	3
C.4.	ANALOGUE INPUT .....	4
C.5.	ANALOGUE INPUT MODULE .....	4
C.6.	STANDARD DIGITAL I/O .....	5
C.7.	DIGITAL INPUT MODULES.....	5
C.8.	DIGITAL OUTPUT MODULES.....	5
C.9.	ANALOGUE OUTPUT MODULES.....	5
C.10.	TRANSMITTER PSU .....	5
C.11.	TRANSDUCER PSU .....	6
C.12.	DUAL DC OUTPUT .....	6
C.13.	HIGH RESOLUTION DC OUTPUT.....	6
C.14.	POTENTIOMETER INPUT .....	6
C.15.	DIGITAL COMMUNICATIONS.....	6
C.16.	ALARMS.....	6
C.17.	USER MESSAGES.....	7
C.18.	CONTROL FUNCTIONS.....	7
C.19.	SETPOINT PROGRAMMER.....	7
C.20.	ADVANCED FUNCTIONS.....	7
C.21.	GENERAL SPECIFICATION .....	8
C.22.	GRAPHICAL REPRESENTATION OF ERRORS .....	9
C.22.1.	mV Input .....	9
C.22.2.	Mid range high impedance Input.....	10
C.22.3.	High Level Input .....	11
C.22.4.	RTD (Pt-100) Input type .....	12
C.22.5.	Thermocouple Input type .....	13

## C. Appendix C Technical Specification

All figures quoted at 0 to 50°C unless otherwise stated.

### C.1. ALL ANALOGUE, DUAL AND PV INPUTS

Sample rate	9Hz (110msec.)
Input filtering	OFF to 999.9 seconds of filter time constant (f.t.c.). Default setting is 0.4 seconds unless stated otherwise
User calibration	Both the user calibration and a transducer scaling can be applied.
Sensor break	a.c. sensor break on each input (i.e. fast responding and no dc errors with high impedance sources).
Thermocouple types	Most linearisations including K,J,T,R,B,S,N,L,PII,C,D,E with linearisation error $< \pm 0.2^{\circ}\text{C}$
General	Resolution (noise free) is quoted as a typical figure with f.t.c. set to the default value = 0.4 second. Resolution generally improves by a factor of two with every quadrupling of f.t.c. Calibration is quoted as offset error + percentage error of absolute reading at ambient temperature of 25°C Drift is quoted as extra offset and absolute reading errors per degree of ambient change from 25°C.



## C.2. PRECISION PV INPUT / MODULE

Allocation (isolated) mV input	One standard and up to two additional PV input modules can be fitted in I/O slots 3 and 6 Two ranges: $\pm 40\text{mV}$ & $\pm 80\text{mV}$ , used for thermocouple, linear mV source or 0 - 20mA with $2.49\Omega$ Calibration: $\pm(1.5\mu\text{V} + 0.05\%$ of reading), Resolution: $0.5\mu\text{V}$ for 40mV range & $1\mu\text{V}$ for 80mV range Drift: $<\pm(0.05\mu\text{V} + 0.003\%$ of absolute reading) per $^{\circ}\text{C}$ Input impedance: $>100\text{M}\Omega$ , Leakage: $< 1\text{nA}$
0 - 2V input	-1.4V to +2V, used for zirconia Calibration: $\pm(0.5\text{mV} + 0.05\%$ of reading) Resolution: $60\mu\text{V}$ Drift: $< \pm(0.05\text{mV} + 0.003\%$ of reading) per $^{\circ}\text{C}$ Input impedance: $>100\text{M}\Omega$ , Leakage: $< 1\text{nA}$
0 - 10V input	-3V to +10V, used for voltage input Calibration: $\pm(0.5\text{mV} + 0.1\%$ of reading) Resolution: $180\mu\text{V}$ Drift: $<\pm(0.1\text{mV} + 0.01\%$ of reading) per $^{\circ}\text{C}$ Input impedance: $0.66\text{M}\Omega$
Pt100 input	0 to 400ohms ( $-200^{\circ}\text{C}$ to $+850^{\circ}\text{C}$ ), 3 matched wires - up to $22\Omega$ in each lead without errors. Calibration: $\pm(0.1^{\circ}\text{C} + 0.04\%$ of reading in $^{\circ}\text{C}$ ) Resolution: $0.02^{\circ}\text{C}$ Drift: $< \pm(0.006^{\circ}\text{C} + 0.002\%$ of absolute reading in $^{\circ}\text{C}$ ) per $^{\circ}\text{C}$ Bulb current: $0.2\text{mA}$ .
Thermocouple	Internal compensation: CJC rejection ratio $>40:1$ typical. CJ Temperature calibration error at $25^{\circ}\text{C}$ : $<\pm 0.5^{\circ}\text{C}$ $0^{\circ}\text{C}$ , $45^{\circ}\text{C}$ and $50^{\circ}\text{C}$ external compensation available.
Zirconia probes	Most probes supported. Continuous monitoring of probe impedance ( $100\Omega$ to $100\text{K}\Omega$ )

## C.3. DUAL (PROBE) INPUT MODULE

General	The same specification as for the Precision PV Input module applies with the exception of the following: Module offers two sensor/transmitter inputs, which share the same negative input terminal. One low level (mV, 0-20mA, thermocouple, Pt100) and one high level (0-2Vdc, 0-10Vdc) can be connected
Isolation	The two inputs are isolated from the rest of the instrument but not from each other
Sample rate (each input)	4.5Hz (220msec)
Input filtering	Default setting is 0.8 seconds

### C.4. ANALOGUE INPUT

No of inputs	One fixed (Not isolated) Can be used with either floating or ground referenced transducers of low impedance.
Input range	-10V to +10V linear or 0 -20 mA with burden resistor of 100Ω. Calibration: $\pm(1.5\text{mV} + 0.1\%$ of reading) Resolution: 0.9mV Drift: $< \pm(0.1\text{mV} + 0.006\%$ of reading) per °C Input Impedance: 0.46MΩ (floating input), 0.23MΩ (ground referenced input)
Isolation	Not isolated from standard digital I/O . Differential type input with common mode range of $\pm 42\text{Vdc}$ (the average voltage of the two inputs with respect to ‘Screen’ or ‘Common’ terminals should be within $\pm 42\text{Vdc}$ . CMRR : $>110\text{dB}$ at 50/60Hz, $>80\text{dB}$ at DC
Functions	Process variable, remote setpoint, power limit, feedforward, etc.

### C.5. ANALOGUE INPUT MODULE

Allocation mV input	Up to 4 analogue input modules can be fitted in I/O slots 1,3,4 & 6 100mV range - used for thermocouple, linear mV source, or 0-20mA with 2.49Ω external burden resistor. Calibration: $\pm 10\mu\text{V} + 0.2\%$ of reading Resolution: 6μV Drift: $< \pm 0.2\mu\text{V} + 0.004\%$ of reading per °C Input impedance: $>10\text{M}\Omega$ , Leakage: $<10\text{nA}$
0 - 2Vdc input	-0.2V to +2.0V range - used for zirconia. Calibration: $\pm 2\text{mV} + 0.2\%$ of reading Resolution: 30μV Drift: $< \pm 0.1\text{mV} + 0.004\%$ of reading per °C Input impedance: $>10\text{M}\Omega$ , Leakage: $<20\text{nA}$
0 - 10Vdc input	-3V to +10.0V range - used for voltage input. Calibration: $\pm 2\text{mV} + 0.2\%$ of reading Resolution: 200μV Drift: $< \pm 0.1\text{mV} + 0.02\%$ of reading per °C Input impedance: $>69\text{K}\Omega$
Pt100 input	0 to 400ohms (-200°C to +850°C), 3 matched wires - up to 22Ω in each lead without errors. Calibration: $\pm(0.4^\circ\text{C} + 0.15\%$ of reading in °C) Resolution: 0.08°C Drift: $< \pm(0.015^\circ\text{C} + 0.005\%$ of reading in °C) per °C Bulb current: 0.3mA.
Thermocouple	Internal compensation: CJC rejection ratio $>25:1$ typical. CJ Temperature calibration error at 25°C: $< \pm 2^\circ\text{C}$ 0°C, 45°C and 50°C external compensation available.

## C.6. STANDARD DIGITAL I/O

Allocation	1 digital input standard and 7 I/O which can be configured as inputs or outputs plus 1 changeover relay
not isolated	
Digital inputs	Voltage level : input active < 2Vdc, inactive >4Vdc Contact closure : input active <100ohms, inactive >28kohms
Digital outputs	Open collector, 24Vdc at 40mA drive capability, requires external supply
Changeover relay	Contact rating 2A at 264Vac resistive
Functions	Refer to Chapter 17
Operations	1,000,000 operations with addition of external snubber

## C.7. DIGITAL INPUT MODULES

Module type	Triple contact input, Triple logic input
Allocation	Can be fitted into slots 1, 3, 4, 5 or 6
Contact closure	Active <100ohms, inactive >28kohms
Logic inputs	Current sinking : active 10.8Vdc to 30Vdc at 2.5mA inactive -3 to 5Vdc at <-0.4mA
Functions	Refer to Chapter 18

## C.8. DIGITAL OUTPUT MODULES

Module types	Single relay, dual relay, single triac, dual triac, triple logic module (isolated)
Allocation	Can be fitted into slot 1, 3, 4, 5 or 6 (max. 3 triac modules per instrument)
Relay rating	2A, 264Vac resistive
Logic drive	12Vdc at 9mA
Triac rating	0.75A, 264Vac resistive
Functions	Refer to Chapter 18

## C.9. ANALOGUE OUTPUT MODULES

Module types	1 channel DC control, 1 channel DC retransmission (5 max.)
Allocation (isolated)	Can be fitted into slot 1, 3, 4, 5 or 6
Range	0-20mA, 0-10Vdc
Resolution	1 part in 10,000 (2,000-noise free) 0.5% accurate for retransmission 1 part in 10,000 2.5% accurate for control
Functions	Refer to Chapter 18

## C.10. TRANSMITTER PSU

Allocation	Can be fitted into slots 1, 3, 4, 5 or 6 (isolated)
Transmitter	24Vdc at 20mA

## C.11. TRANSDUCER PSU

Bridge voltage	Software selectable 5 or 10Vdc
Bridge resistance	300 $\Omega$ to 15K $\Omega$
Internal shunt resistor	30.1K $\Omega$ at 0.25%, used for calibration of 350 $\Omega$ bridge resistor

## C.12. DUAL DC OUTPUT

Current Output	4-20mA, 20V output span
Accuracy	1%, 11 bit noise free resolution
Speed	50ms response
Transmitter/logic PSU	20V min at full 22mA current load. 30V max at open circuit short circuit protected at 22-24mA

## C.13. HIGH RESOLUTION DC OUTPUT

Current Output	4-20mA, 20V output span
Accuracy	1%, 15 bit noise free resolution
Speed	40ms response
Transmitter/logic PSU	20V min at full 22mA current load. 30V max at open circuit short circuit protected at 21-28mA

## C.14. POTENTIOMETER INPUT

Potentiometer resistance	330 $\Omega$ to 15K $\Omega$ , excitation of 0.5 volts
--------------------------	--

## C.15. DIGITAL COMMUNICATIONS

Allocation	2 modules fitted in slots H & J (isolated)
Modbus	RS232, 2 wire or 4 wire RS485, max baud 19.2KB in H module & 9.6KB in J module
Profibus-DP	High speed, RS485, 1.5Mbaud

## C.16. ALARMS

No of Alarms	Input alarms (2), loop alarms (2) User alarms (8)
Alarm types	Full scale, deviation, rate of change, sensor break plus application specific
Modes	Latching or non-latching, blocking, time delay
Parameters	Refer to Chapter 8

## C.17. USER MESSAGES

No of messages	Maximum 50, triggered by operator or alarm or used for custom parameter names
Format	Up to 16 characters

## C.18. CONTROL FUNCTIONS

No of loops	One, two or three
Modes	On/off, PID, motorised valve with or without feedback
Options	Cascade, ratio, override or feed forward
Cooling algorithms	Linear, water, oil or fan
PID sets	3 per loop (Cascade loop includes master and slave parameters)
Manual mode	Bumpless transfer or forced manual output, manual tracking available
Setpoint rate limit	Display units per second, minute or hour

## C.19. SETPOINT PROGRAMMER

No of programs	A maximum of 50 programs assignable over 500 segments for a time to target programmer and 400 segments for a ramp rate programmer. A program can consist of up to 3 variables. Programs can be given user defined 16 character names
Event outputs	Up to 16, can be assigned individually to segments or called as part of an event group

## C.20. ADVANCED FUNCTIONS

Application blocks	32 digital operations 24 Analogue calculations
Timers	4, On Pulse, Off delay, one shot and min-On
Totalisers	4, trigger level & reset input
Real time clock	Day of week and time
Pattern generators	16 x 16, 2 off

## C.21. GENERAL SPECIFICATION

Display range	5 digits including up to 3 decimal places
Supply	85-264Vac, 20Watts (max)
Operating ambient	0 - 50°C and 5 to 95% RH non condensing
Storage temp	-10 to +70°C
Panel sealing	IP65
Dimensions	96H x 96W x 150D (mm)
EMC standards	EN61326 electrical equipment for measurement, control and laboratory use EMS requirements - suitable for, commercial and light industrial as well as heavy industrial environments With Devicenet module fitted product is suitable for heavy industrial environments only (class A emissions).
Safety standards	Meets EN61010 installation category II, pollution degree 2
Atmospheres	Not suitable for use above 2000m or in explosive or corrosive atmospheres
Inrush Current	High Voltage controller – 30A duration 100µs Low Voltage controller – 15A duration 100µs

## C.22. GRAPHICAL REPRESENTATION OF ERRORS

This section shows graphically the effects of adding all contributions of different errors for each input type and range. The errors are a combination of:

Calibration accuracy, Drift with ambient temperature, Linearity error, Leakage

### C.22.1. mV Input

Two ranges:

working range	$\pm 40\text{mV}$			
full linear range	$\pm 60\text{mV}$			
noise (resolution)	1 $\mu\text{V}$ - OFF,	0.5 $\mu\text{V}$ - 0.4sec,	0.25 $\mu\text{V}$ - 1.6sec	
working range	$\pm 80\text{mV}$			
full linear range	$\pm 105\text{mV}$			
noise (resolution)	2 $\mu\text{V}$ - OFF,	1 $\mu\text{V}$ - 0.4sec,	0.5 $\mu\text{V}$ - 1.6sec	

Calibration accuracy @ 25°C

$$< \pm (1.5\mu\text{V} + 0.05\% \text{ of } |\text{reading}|)$$

Drift with ambient temperature

$$< \pm (0.05\mu\text{V} + 0.003\% \text{ of } |\text{reading}|) \text{ per } ^\circ\text{C}$$

Linearity error

$$< \pm 0.002\% \text{ of span (i.e. } < 1\mu\text{V, } < 2\mu\text{V)}$$

Leakage

$$< \pm 1\text{nA (typically } \pm 200\text{pA)}$$

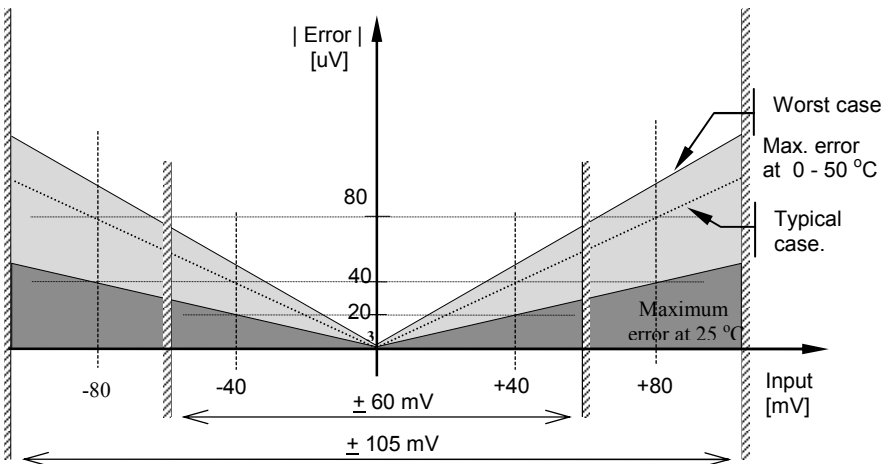

Figure C-1: Error Graph - mV Input

### C.22.2. Mid range high impedance Input

#### 0 - 2V Input type

Range:

working range -1.4V to +2V

full linear range -1.8V to +2.4V

noise (resolution) 100uV - OFF, 50uV - 0.4sec, 35uV - 1.6sec

Calibration accuracy @ 25°C

$< \pm (0.5\text{mV} + 0.05\% \text{ of } |\text{reading}|)$

Drift with ambient temperature

$< \pm (0.05\text{mV} + 0.003\% \text{ of } |\text{reading}|) \text{ per } ^\circ\text{C}$

Linearity error

$< \pm 0.01\% \text{ of span (i.e. } \pm 200\text{uV)}$

Input Impedance & Leakage

$> 100\text{M}\Omega$   $< 1\text{nA}$

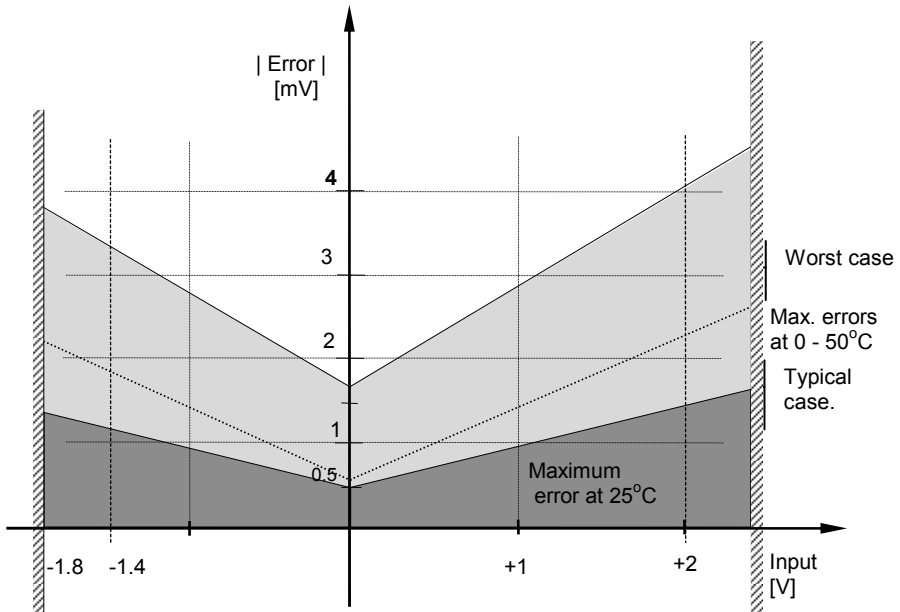

Figure C-2: Error Graph - 0 - 2V Input



### C.22.3. High Level Input

#### 0 - 10V Input type

Range:

working range	-3V to +10V		
full linear range	- 5V to +14V		
noise (resolution)	300uV - OFF,	150uV - 0.4sec,	100uV - 1.6sec

Calibration accuracy @ 25°C

$$< \pm (0.5\text{mV} + 0.1\% \text{ of } |\text{reading}|)$$

Drift with ambient temperature

$$< \pm (0.01\text{mV} + 0.006\% \text{ of } |\text{reading}|) \text{ per } ^\circ\text{C}$$

Linearity error

$$< \pm 0.02\% \text{ of span (i.e. } \pm 2\text{mV)}$$

Input Impedance

$$0.66 \text{ M}\Omega$$

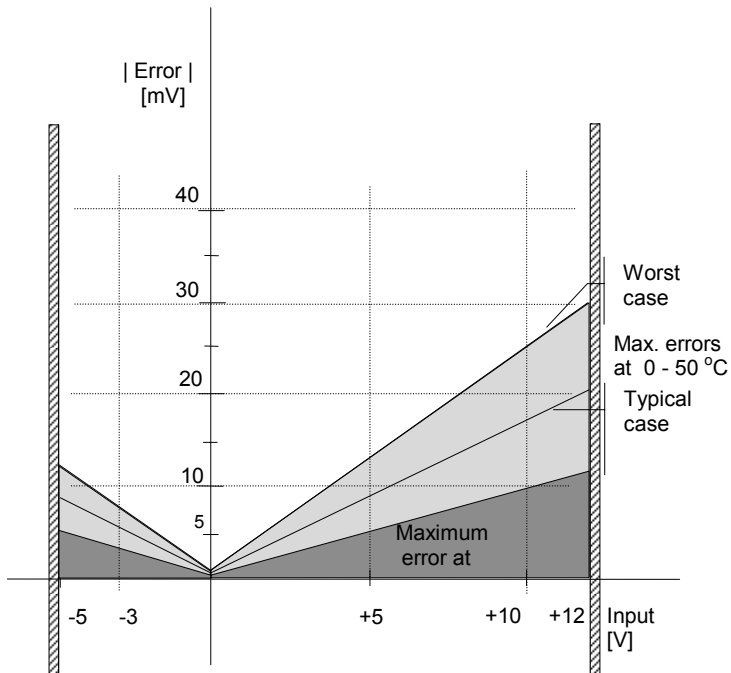

Figure C-3: Error Graph - 0 - 10V Input

### C.22.4. RTD (Pt-100) Input type

Resistance measurement specification in Ohms:

Range

0 to 400Ω with up to 22Ω in each connecting lead

Noise (resolution)

8mΩ - 0.4sec,                      4mΩ - 1.6sec

Calibration accuracy limits @ 25°C

< ± (35mΩ @110Ω + 0.03% of |reading - 110Ω|)

Drift with ambient temperature

± (0.002% of |reading|) per °C

Linearity error

< ±15 mΩ

Pt-100 measurement specification in °C:

Range

-200 °C to +850 °C

Noise (resolution)

0.02 °C - 0.4sec,                      0.01 °C - 1.6sec

Calibration accuracy limit @ 25°C

< ± (0.1 °C + 0.03% of |reading in °C|)

Drift with ambient temperature

< ± (0.0055 °C + 0.002% of |reading in °C|) per °C of ambient change

Linearity + Linearisation error

< ± 55 °mC                                      (i.e. 50 °mC + 5 °mC)

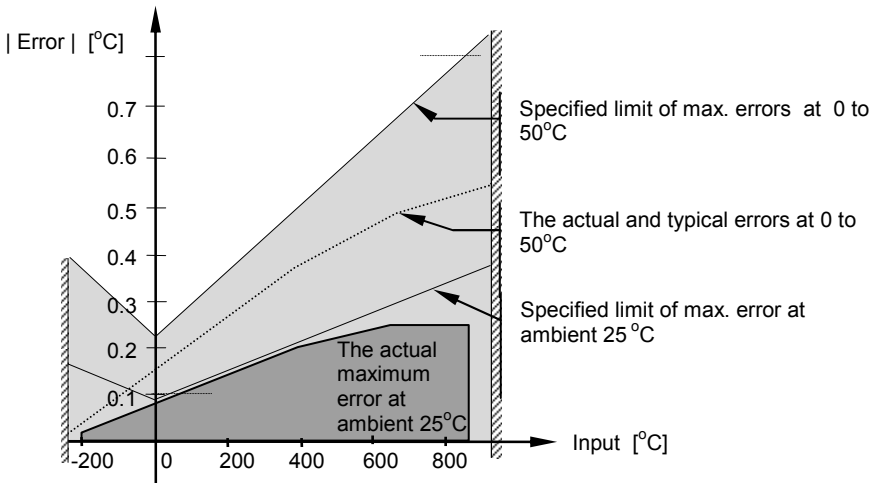

Figure C-4: Error Graph - RTD Input

## C.22.5. Thermocouple Input type

Internal CJT sensing spec

Calibration error @ 25 °C (including temp. difference between top and bottom screws)  
 $< \pm 0.5 \text{ }^\circ\text{C}$

Total CJT error

$< \pm (0.5 \text{ }^\circ\text{C} + 0.012 \text{ }^\circ\text{C per } 1 \text{ }^\circ\text{C of ambient change})$   
 ( i.e. CJC Rejection for measured temperatures above 0 °C is  $> 80 : 1$  )

Noise (resolution)

0.01 °C

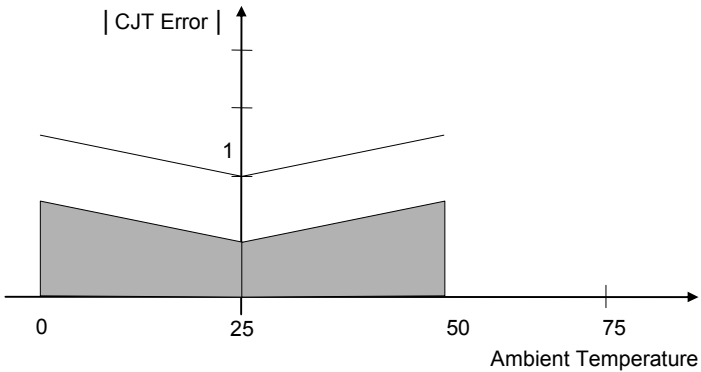

Figure C-5: Overall CJT Error at Different Ambient Temperatures





# INTERNATIONAL SALES AND SERVICE

**AUSTRALIA** *Sydney*  
Eurotherm Pty. Ltd.  
Telephone (+61 2) 9838 0099  
Fax (+61 2) 9838 9288  
E-mail [info@eurotherm.com.au](mailto:info@eurotherm.com.au)

**AUSTRIA** *Vienna*  
Eurotherm GmbH  
Telephone (+43 1) 7987601  
Fax (+43 1) 7987605  
E-mail [eurotherm@eurotherm.at](mailto:eurotherm@eurotherm.at)

**BELGIUM & LUXEMBURG** *Huy*  
Eurotherm S.A./N.V.  
Telephone (+32) 85 274080  
Fax (+32) 85 274081  
E-mail [sales@eurotherm-belgium.be](mailto:sales@eurotherm-belgium.be)

**BRAZIL** *Campinas-SP*  
Eurotherm Ltda.  
Telephone (+5519) 3707 5333  
Fax (+5519) 3707 5345  
E-mail [eurothermltda@eurothermltda.com.br](mailto:eurothermltda@eurothermltda.com.br)

**DENMARK** *Copenhagen*  
Eurotherm Danmark A/S  
Telephone (+45 70) 234670  
Fax (+45 70) 234660  
E-mail [info@eurotherm.se](mailto:info@eurotherm.se)

**FINLAND** *Abo*  
Eurotherm Finland  
Telephone (+358) 22506030  
Fax (+358) 22503201

**FRANCE** *Lyon*  
Eurotherm Automation SA  
Telephone (+33 478) 664500  
Fax (+33 478) 352490  
E-mail  
[ea@automation.eurotherm.co.uk](mailto:ea@automation.eurotherm.co.uk)

**GERMANY** *Limburg*  
Eurotherm Deutschland GmbH  
Telephone (+49 6431) 2980  
Fax (+49 6431) 298119  
E-mail [info@regler.eurotherm.co.uk](mailto:info@regler.eurotherm.co.uk)

**HONG KONG & CHINA**  
Eurotherm Limited *North Point*  
Telephone (+85 2) 28733826  
Fax (+85 2) 28700148  
E-mail [eurotherm@eurotherm.com.hk](mailto:eurotherm@eurotherm.com.hk)

Guangzhou Office  
Telephone (+86 20) 8755 5099  
Fax (+86 20) 8755 5831

Beijing Office  
Telephone (+86 10) 6567 8506  
Fax (+86 10) 6567 8509

Shanghai Office  
Telephone (+86 21) 6145 1188  
Fax (+86 21) 6145 1187

**INDIA** *Chennai*  
Eurotherm India Limited  
Telephone (+9144) 24961129  
Fax (+9144) 24961831  
E-mail [sales@eurothermdel.com](mailto:sales@eurothermdel.com)

**IRELAND** *Dublin*  
Eurotherm Ireland Limited  
Telephone (+353 01) 469180  
Fax (+353 01) 4691300  
E-mail [info@eurotherm.ie](mailto:info@eurotherm.ie)

**ITALY** *Como*  
Eurotherm S.r.l.  
Telephone +39 (0)31 975111  
Fax +39 (0)31 977512  
E-mail [info@eurotherm.it](mailto:info@eurotherm.it)

**KOREA** *Seoul*  
Eurotherm Korea Limited  
Telephone (+82 31) 2738507  
Fax (+82 31) 2738508  
E-mail [help@eurotherm.co.kr](mailto:help@eurotherm.co.kr)

**NETHERLANDS** *Alphen a/d Rijn*  
Eurotherm B.V.  
Telephone (+31 172) 411752  
Fax (+31 172) 417260  
E-mail [sales@eurotherm.nl](mailto:sales@eurotherm.nl)

**NORWAY** *Oslo*  
Eurotherm A/S  
Telephone Oslo (+47 67) 592170  
Fax (+47 67) 118301  
E-mail [info@eurotherm.se](mailto:info@eurotherm.se)

**SPAIN** *Madrid*  
Eurotherm España SA  
Telephone (+34 91) 6616001  
Fax (+34 91) 6619093  
E-mail [ventas@iberica.eurotherm.co.uk](mailto:ventas@iberica.eurotherm.co.uk)

**SWEDEN** *Malmo*  
Eurotherm AB  
Telephone (+46 40) 384500  
Fax (+46 40) 384545  
E-mail [info@eurotherm.se](mailto:info@eurotherm.se)

**SWITZERLAND** *Freienbach*  
Eurotherm Produkte (Schweiz) AG  
Telephone (+41 55) 4154400  
Fax (+41 55) 4154415  
E-mail [epsag@eurotherm.ch](mailto:epsag@eurotherm.ch)

**UNITED KINGDOM** *Worthing*  
Eurotherm Limited  
Telephone (+44 1903) 268500  
Fax (+44 1903) 265982  
E-mail [info@eurotherm.co.uk](mailto:info@eurotherm.co.uk)  
Web [www.eurotherm.co.uk](http://www.eurotherm.co.uk)

**U.S.A** *Leesburg VA*  
Eurotherm Inc.  
Telephone (+1 703) 443 0000  
Fax (+1 703) 669 1300  
E-mail [info@eurotherm.com](mailto:info@eurotherm.com)  
Web [www.eurotherm.com](http://www.eurotherm.com)

ED47

© Copyright Eurotherm Limited 2006

All rights are strictly reserved. No part of this document may be reproduced, modified, or transmitted in any form by any means, nor may it be stored in a retrieval system other than for the purpose to act as an aid in operating the equipment to which the document relates, without the prior written permission of Eurotherm limited. Eurotherm Limited pursues a policy of continuous development and product improvement. The specifications in this document may therefore be changed without notice. The information in this document is given in good faith, but is intended for guidance only. Eurotherm Limited will accept no responsibility for any losses arising from errors in this document.

