

# CAL 3200 AUTOTUNE TEMPERATURE CONTROLLER OPERATING MANUAL



CAL Controls

# 1 IMPORTANT SAFETY INFORMATION ... PLEASE REVIEW

## 1.1 INSTALLATION



Designed for use:  
UL873 – only in products where the acceptability is determined by Underwriters Laboratories Inc.  
EN61010-1 – within Installation Categories II and III environment and pollution degree 2.

To avoid possible hazards accessible conductive parts of final installation should be protectively earthed in accordance with EN61010 for Class 1 equipment. Output wiring should be within a grounded cabinet. Sensor sheaths should be bonded to ground or not be accessible.

Live parts should not be accessible without use of a tool. It is the responsibility of the installation engineer to ensure that this equipment's compliance to EN61010 is not impaired when fitted to the final installation and to use this equipment as specified in this manual, failure to do so may impair the protection provided. Ensure the installation is in compliance with appropriate wiring regulations

## 1.2 CONFIGURATION

All functions are front key selectable, it is the responsibility of the installing engineer to ensure that the configuration is safe. Use the program lock to protect critical functions from tampering

## 1.3 ULTIMATE SAFETY ALARMS

Normal safety advice: Do not use SP2 as the sole alarm where personal injury or damage may be caused by equipment failure

## WARRANTY

**CAL Controls warrant this product free of defects in workmanship and materials for three (3) years from date of purchase**

- Should the unit malfunction, return it to the factory. If defective it will be repaired or replaced at no charge
- There are no user-serviceable parts in this unit. This warranty is void if the unit shows evidence of being tampered with or subjected to excessive heat, moisture, corrosion or other misuse
- Components which wear, or damage with misuse, are excluded e.g. Relays
- CAL Controls shall not be responsible for any damage or losses however caused, which may be experienced as a result of the installation or use of this product. CAL Controls liability for any breach of this agreement shall not exceed the purchase price paid E. & O.E.

## IN BRIEF ...

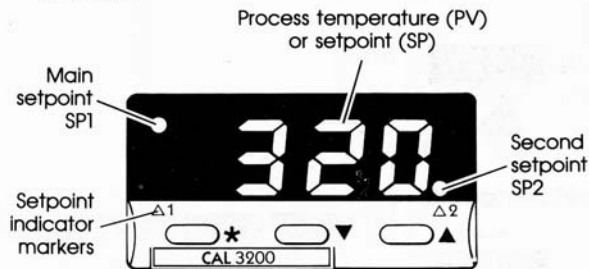

## Routine adjustments

- \* View setpoint
- \* ▲ Increase setpoint
- \* ▼ Decrease setpoint

## To reset alarm or fault message

- ▼ ▲ Momentarily press together

## SYMBOLS USED IN THE MANUAL

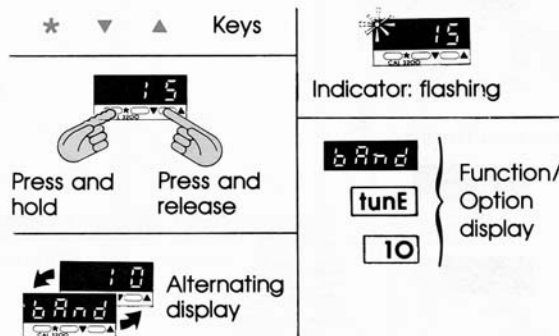

Thank you for choosing the CAL 3200 .....  
a new concept in advanced, full feature,  
compact temperature control



**Please ....**

**Familiarise yourself:**

Scan the contents list and look through the manual, note sections of interest



**Before installation:**

Review the important safety information in section 1



**Installation and connection:**

Instructions see sections 4/5



**Setting-up instructions**

Choose the format you prefer:



**Fully explained step-by-step**

Start section 6

or ...



**Abbreviated instructions**

Minimum explanation for those familiar with micro-processor based controllers ... section 3 under front flap

**INTRODUCTION**

Section	Page
<b>1</b> IMPORTANT SAFETY INFORMATION	<b>P1</b>
<b>2</b> CONTROL FUNCTIONS MENU	<b>P3</b>
<b>3</b> ABBREVIATED SETTING-UP GUIDE	<b>P4</b>
<b>4</b> MECHANICAL INSTALLATION	<b>P5</b>
<b>5</b> ELECTRICAL INSTALLATION	<b>P6</b>
<b>6</b> INITIAL CONFIGURATION / SETTING-UP / FACTORY SETTINGS	<b>P7</b>
<b>7</b> AUTOTUNE	<b>P9</b>
<b>8</b> VIEWING AND SELECTING FUNCTIONS	<b>P11</b>
<b>9</b> PROPORTIONAL CYCLE-TIME	<b>P13</b>
<b>10</b> SECOND SETPOINT – SP2 ALARMS AND COOL STRATEGY	<b>P15</b>
<b>11</b> RANGING AND SETPOINT LOCK	<b>P17</b>
<b>12</b> IMPROVING CONTROL ACCURACY	<b>P17</b>
<b>13</b> OEM PROGRAM SECURITY	<b>P18</b>
<b>14</b> OEM SECURE LEVEL 4	<b>P19</b>
<b>15</b> ERROR MESSAGES AND DIAGNOSIS	<b>P19</b>
<b>16</b> FUNCTIONS AND OPTIONS: LEVEL 1	<b>P20</b>
<b>17</b> 3200 SPECIFICATION	<b>P24</b>
<b>18</b> CUSTOMER CONFIGURATION RECORD	<b>REAR</b>

To reset alarms and error messages:

Press ▼▲ together briefly

## 2 FUNCTIONS MENU AND PROGRAM MODE GUIDE

### Brief Guide:

- 1. Enter/exit**  
program mode  
Press and hold  
▼▲ 3 sec



### 2. Single level navigation

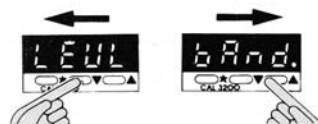

### 3. View/Change Option

- View  
Function/  
Option



- Autotune  
Option value



- To change  
Option value  
(or \* ▼ )  
Release: check correct

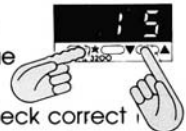

### 4. Changing menu levels

- Locate level  
Function



- Select new  
level

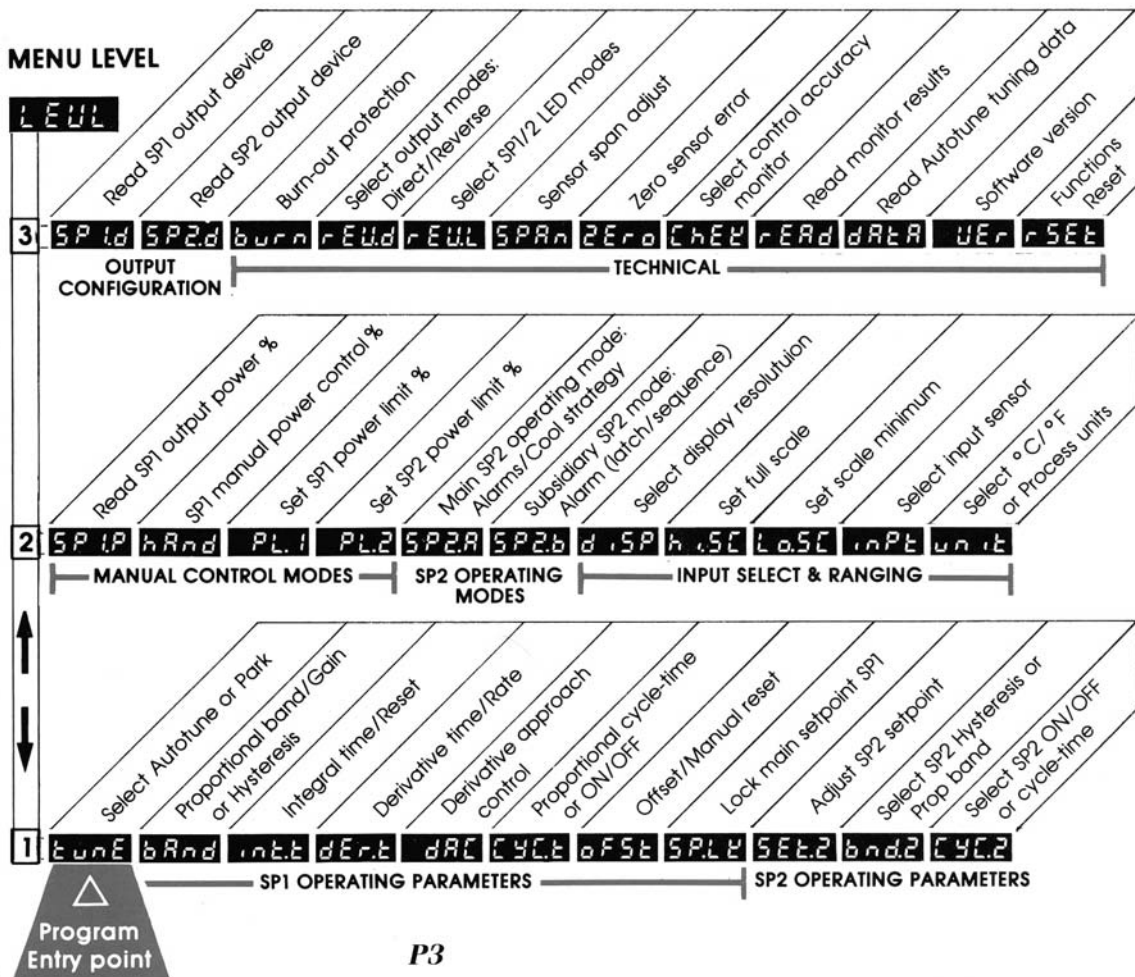

### 3 ABBREVIATED SETTING-UP INSTRUCTIONS

... FOR FULL INSTRUCTIONS SEE SECTION 6 ...

#### 1. Power-up

Alternating display after self-test



#### 2. Select input sensor

To select:  
Press and hold \*  
Press ▲



Check correctly selected



#### 3. Select °C/°F

Press once



To select



#### 4. Select main setpoint output device see 5.3

Press once



Select:  
**SSR drive**



or

**2A relay**



**Important:**

Check correct device selected



#### If any difficulty in initial configuration:

Press and hold ▼▲ 3 sec  
To display the next step, release keys together



#### 5. Enter initial configuration

Hold both 3 sec



Normal operating mode:  
No setpoint entered yet



#### 6. Select other functions

Now or later:  
see guide and menu to left

#### 7. Setpoint display/adjust

Display setpoint



To increase setpoint



To decrease setpoint



#### 8. To Autotune

Enter program mode  
hold both 3 sec



Entry point



Select

**tune/on**

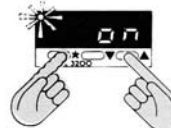

Exit program mode  
Hold both 3 sec



Display during Autotune



Note: Setpoint locked during Autotune.  
to adjust **tune/oFF**

**9. For optimum cycle-time see 9.4**

Operational with factory PID settings

## 4 MECHANICAL INSTALLATION

1. Prepare a 1/32 DIN panel cutout:  
45.0mm +0.6/-0 x 22.2mm +0.3/-0  
1.77" +0.02/-0 x 0.87" +0.01/-0
2. Unplug connector now if wiring separately
3. Slide the controller into the cutout
4. Slide the panel clamp on the controller and press it firmly against the panel  
Note: To remove the panel clamp the two side levers should be pressed in
5. Refit the connector if removed. To further secure the connector slide the green lock as shown
6. After installation remove protective front window label
7. Cleaning – wipe down front with damp cloth (water only)

### 4.1 3200 CONTROLLER PROTECTION RATING

The 3200 controller front of panel assembly is rated NEMA 4X/IP66 provided:

- The panel is smooth, and cutout accurate
- The panel clamp is pressed firmly against the panel, ensuring that the clamp springs are fully compressed

### 4.2 MULTIPLE 3200 INSTALLATIONS

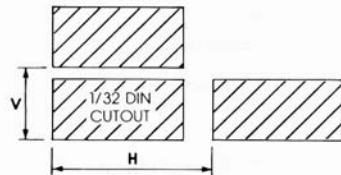

#### Guide for spacing:

	V	H
Minimum	30 (1.18)	60 (2.36)
Allows clamp removal	30 (1.18)	70 (2.76)
Allows clamp and connector removal ... <b>Recommended</b>	35 (1.38)	70 (2.76)

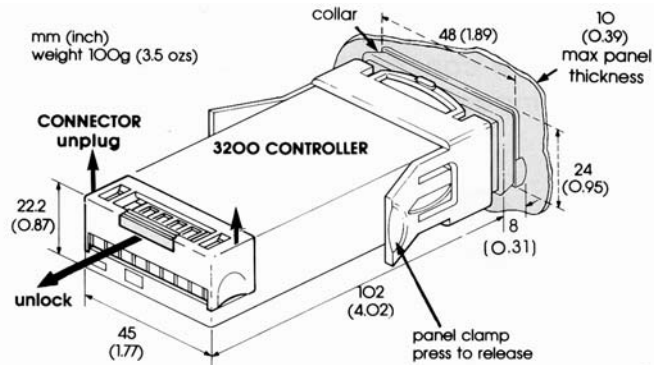

**OPTIONAL 1/16 DIN PANEL ADAPTORS:** 48 (1.89) square  
Enable 3200(s) to be mounted in a 1/16 DIN cutout

### 4.3 1/16 DIN 3200 adaptor: Accepts one 3200

1. Remove collar/gasket from 3200, grip firmly and pull off
2. Assemble adaptor halves either side of panel, locate pegs
3. Slide 3200 into adaptor, fit panel clamp and press firmly against adaptor

1/16 DIN PANEL CUTOUT 45 x 45 +0.6/-0  
(1.77 x 1.77 +0.02/-0)

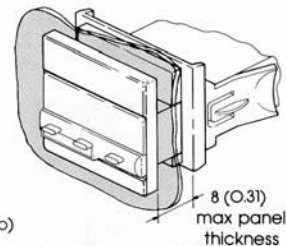

### 4.4 1/16 DIN 3200 Twin adaptor: Accepts two 3200s

1. Remove collars from both 3200s
2. Fit special collars included with twin panel clamp
3. Slide both 3200s into cutout, fit twin panel clamp and press firmly against panel

PANEL CUTOUT 45 x 46.2 +0.6/-0  
(1.77 x 1.82 +0.02/-0)

Panel adaptors are not NEMA 4X/IP66 rated

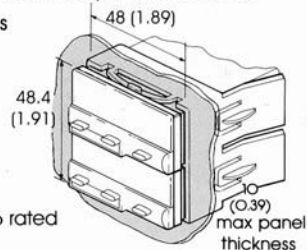

## 5 ELECTRICAL INSTALLATION

### CAUTION RISK OF ELECTRIC SHOCK

**5.1 Supply Voltage:** 100-240V 50-60 Hz $\pm$ 10% 3VA  
12V or 24V (AC/DC) $\pm$ 20% 3VA  
Polarity not required  
3200 is fitted with internal 250mA time lag fuse

### 5.2 Output devices (two)

**Solid state relay drive** **SSd**  
5Vdc  $\pm$ 0/-15%, 10mA non-isolated  
To switch a remote SSR (or logic)

**Miniature power relay** **rLY**  
2A/250V~resistive, Form A/SPST contacts

### 5.3 Output device allocation

Either the SSd or the relay may be chosen as the output device for the main setpoint SP1, the remaining device being automatically allocated to the second setpoint SP2. Choose the most suitable output device arrangement for the application and wire accordingly

### 5.4 Wiring the 8 way connector

Maximum recommended wire: 32/0.2mm 1.0mm<sup>2</sup> (18AWG 0.04"²). Prepare cables carefully.  
**Important:** remove a maximum of 6mm (0.25") insulation to avoid bridging. Prevent excessive cable strain on the connector

### 5.5 Switching inductive loads with the relay

To prolong contact life and suppress interference it is good engineering practice to fit a snubber (0.1 $\mu$ f/100 ) **see Example B**  
Caution: Snubber leakage current can cause some electro-mechanical devices to be held ON. Check manufacturers specification

### Example A

The SSd output is allocated to SP1 and wired to switch the load (heater) using an SSR

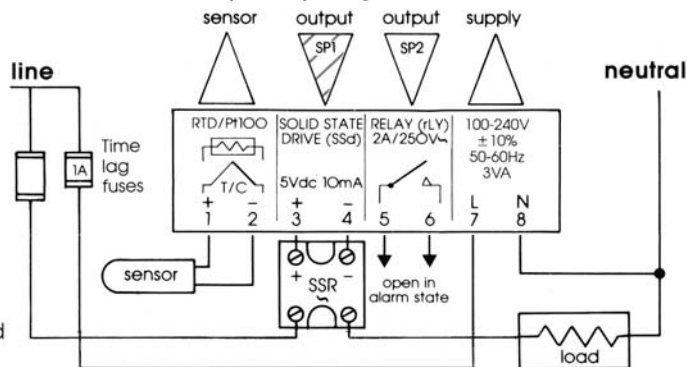

### Example B

The relay output is allocated to SP1 and wired to switch the load (heater) using a contactor

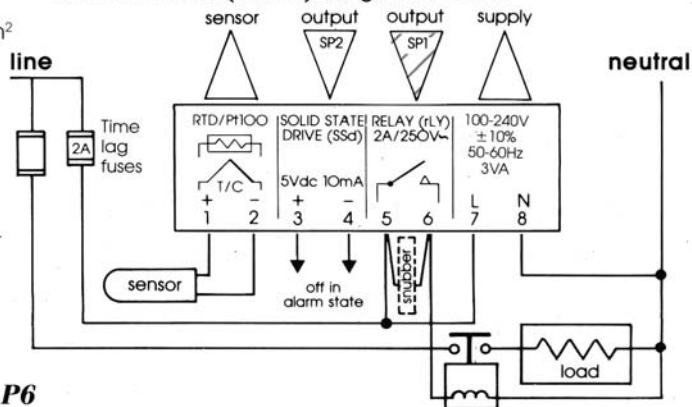

## 6 INITIAL SETTING UP

### 6.1 OVERVIEW

Three steps from initial power-up to accurately tuned control

#### 6.1.1 Details required for initial configuration

1. The temperature sensor being used: thermocouple or RTD/Pt100
2. °C or °F
3. Choice of controller output device for the main setpoint SP1, either:  
The solid state relay drive **SSd**  
or the miniature power relay **rLY**
4. Any additional controller functions, e.g. SP2 Alarms, may be selected now or later

#### 6.1.2 Set the temperature required

The controller is now operational with factory PID settings

#### 6.1.3 To tune the 3200 precisely to the application:

- Run the Autotune program **see 7**  
This automatically adjusts the PID control parameters to the characteristics of the application
- Or enter PID values manually  
Where the optimum values are already known

#### NOTE:

If any difficulty in initial configuration:  
Press and hold  $\blacktriangledown\blacktriangle$  3 sec  
To display the next step  
Release keys together

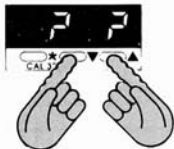

## 6.2 INITIAL CONFIGURATION

### 6.2.1 Power up

Self test sequence (and brief display blanking)

The alternating display shows that no input sensor is selected and that one is required

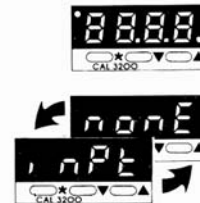

### 6.2.2 To enter the input sensor type

Press and hold \*

Press  $\blacktriangle$  to select the sensor e.g. K

Press  $\blacktriangledown$  to reverse indexing



#### Input sensor options (also see 16.2.10)

##### Thermocouples

sensor type	mnemonic
B	t c b
E	t c E
J	t c J
K	t c K
L	t c L

sensor type	mnemonic
N	t c n
R	t c r
S	t c S
T	t c t

##### Resistance thermometer

RTD-2	
Pt100	r t d

#### Linear process inputs, see 16.2.10

After selection release \*

Check that the selection is correct





### 6.2.3 To select display in °C or °F

Press ▲ once



The display shows that no display unit is selected



To select °C or °F  
(Bar, PSI, Ph, Rh)

Press and hold \*

Press ▲ to select °C, °F etc

Release \*

Check display alternating with **unit** is correct



### 6.2.4 To allocate SP1 - main setpoint output device

Press ▲ once



The display shows that no output device has been allocated to SP1



#### Available SP1 output devices:

Solid state relay drive



Miniature power relay



The remaining output device is automatically allocated to SP2

To select SP1 output device

Press and hold \*

Press ▲ to select



#### Important:

Check correct device selected, as fixed once entered in memory, changeable only on full reset, see 16.3.12



### 6.2.5 To enter the initial configuration into the Controllers memory

Press and hold both ▼ and ▲ for 3 seconds (Display may differ)



Process temperature displayed e.g. Ambient 23 °C and alternate as no setpoint yet selected



### 6.2.6 To display setpoint

Press and hold \*

°C/O or °F/32 alternate



### 6.2.7 To adjust setpoint

Press and hold \*

Press ▲ to increase/

▼ to decrease

Flashing LED shows SP1 output ON.

The temperature rises



### Controller operational with factory PID settings:

Proportional band/Gain 10 °C/18 °F  
 Integral time/Reset 5 mins  
 Proportional cycle-time 20 secs  
 Derivative time/Rate 25 secs  
 DAC Derivative approach control 1.5

## 7.1 TO USE AUTOTUNE – TUNE PROGRAM

### 7.1.1 For best results:

- Start with the load cool
- Set the usual setpoint temperature and use normal load conditions

### 7.1.2 To enter program mode

Press and hold both ▼▲ for 3 seconds

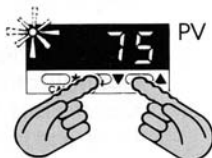

Release together when **tunE** is displayed on entry to program mode  
If display differs, **see 2** for functions menu, press ▼ or ▲ to locate **tunE**



### 7.1.3 To select **tunE/OFF**

Press and hold \*  
Press ▲ once



Release \*



### 7.1.4 To start TUNE program

Press and hold both ▼▲ for 3 seconds

To exit program mode starting **tunE** (Display may differ)

Release ▼▲

Display during **tunE** program

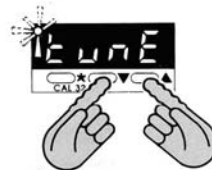

NOTE: Setpoint is locked during **tunE** to adjust

select **tunE/OFF**



**TUNE** program complete

Alternating display stops

New PID values are entered automatically



Process temperature climbs to setpoint



### The Autotune – TUNE program

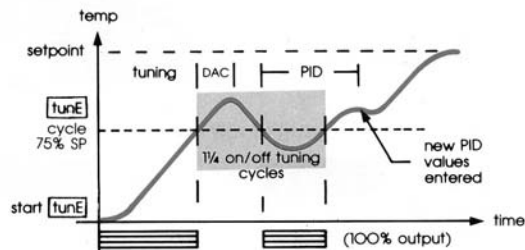

## 7.2 MORE ON AUTOTUNE

### 7.2.1 Operation

Autotune 'teaches' the controller the main characteristics of the process. For best results run Autotune with the usual setpoint temperature under normal load conditions

Autotune 'learns' by cycling the output on and off. The results are measured and used to calculate optimum PID values which are automatically entered in the controller memory

#### PID Parameters tuned

1. Proportional band/Gain
2. Proportional cycle-time (requires manual acceptance unless pre-selected, **see 9**)
3. Integral time/Reset
4. Derivative time/Rate
5. Derivative approach control (DAC)

Two alternative forms of Autotune are provided, **TUNE** and **TUNE AT SETPOINT**, the use of each is described below

### 7.2.2 The Autotune - TUNE program



To run **TUNE** select **tunE/on**, **see 7.1**  
Start with the load cool. The output is cycled at 75% of the setpoint value to avoid any overshoot during the tuning cycle.  
The warm-up characteristics are monitored to set DAC which minimises overshoot on subsequent warm-ups

### 7.2.3 The Autotune - TUNE AT SETPOINT program



To run **TUNE AT SETPOINT** select **tunE/At.SP**  
**see 7.1.3**: Press **\*** and hold, press **▲** 3 times  
The tuning cycle occurs **at setpoint** and in some applications, may give better results, see examples below:

**The TUNE AT SETPOINT program is recommended:**

1. When the setpoint is below 100°C/200°F, where **TUNE's** tuning cycle at 75% setpoint may be too close to ambient to produce good results
2. When the process is already hot and the cooling rate is slow
3. When controlling multi-zone or heat-cool applications
4. To re-tune if the setpoint is changed substantially from the previous Autotune

Note: DAC is not re-tuned by Tune at Setpoint

#### The Autotune - TUNE AT SETPOINT program

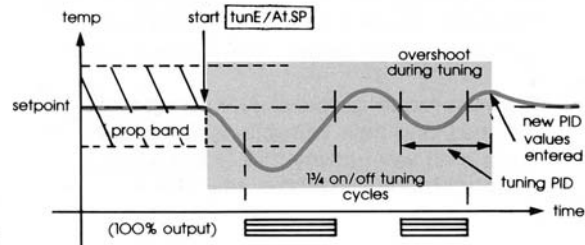

## 8.1 FUNCTIONS AND OPTIONS

The facilities of the 3200 are selected from the multi-level menu using program mode

**For menu of main Functions .. see 2**

**For Functions and Options list .. see 16**

### 8.1.1 Definitions

**Functions (Fn):** The controllers facilities

**Options (Opt):** The available values for a function

Example:

**Function:** Proportional band

**Option:** 15 °C / °F selected



**Short reference:** **bAnd/15** (Fn/Opt)

### 8.1.2 Control during programming

Control with existing settings is maintained during programming. Control with new instructions commences only on exiting program mode, when the controller memory is updated

### 8.1.3 Hints when using program mode

Some options will not adjust! Maybe the lock has been applied. All functions and current options may be viewed even when locked

Program mode auto-exit: Normal operation is restored, and new instructions entered, if there is no key activity for 60 sec when in program mode (to disable, see 14.4.4)

### 8.1.4 The multi-level Function and Option menu For menu of main Functions .. see 2

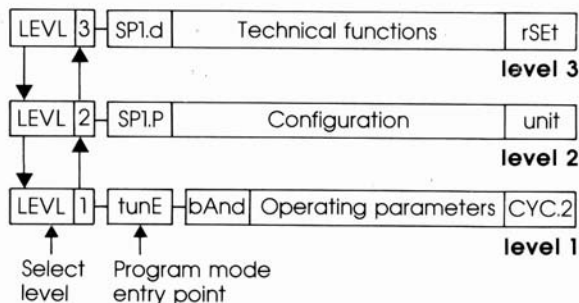

## 8.2 USING PROGRAM MODE

### 8.2.1 To enter program mode from normal operating mode

Press and hold both ▼▲ for 3 seconds

Enter program mode at **tunE** Function on level 1, see diagram above

Release both ▼▲ together

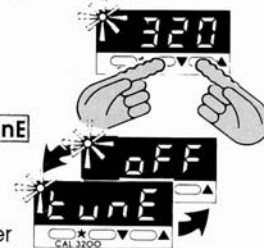

### 8.2.2 To exit program mode at any time returning to normal operating mode

Press and hold both ▼▲ for 3 seconds

NOTE: Control commences with any new instructions now entered in memory



### 8.2.3 To view Functions on the same level

Press ▼ or ▲ once to view the next Function

or hold ▼ or ▲ to auto-index through the Functions

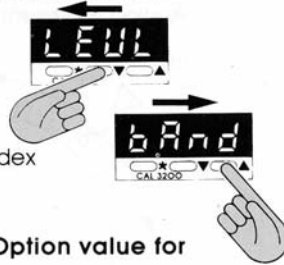

### 8.2.4 To display the current Option value for a Function

On release of ▼ or ▲ Option alternates with the Function:  
Function **bAnd**  
Option **10** °

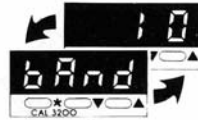

### 8.2.5 Autotune Option values

Autotune calculated value indicator

If a manual Option is selected, the Autotune value is retained in memory



### 8.2.6 To change an Option value or setting

Index to the required Function e.g. **bAnd**  
Press and hold \*  
Current Option displayed: **10** °

Press ▲ to increase/ ▼ to decrease  
e.g. **bAnd** increased to **15** °  
Release \*

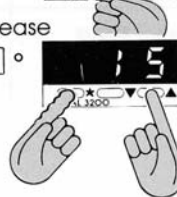

**IMPORTANT:**  
Check the new Option value **before** moving to another Function or exiting program mode

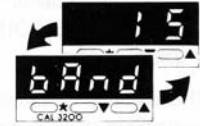

### 8.2.7 To change menu levels

Press and hold ▼ to reach the level selection function

Release ▼ to display the current level **1**



Press and hold \*  
Press ▲ to increase level (2)  
or Press ▼ to decrease level

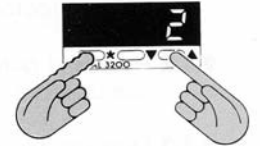

Release \* to display the new level **2**



### Reminder:

Use ▼ and ▲ to locate Functions on each level  
To exit program mode and return to normal operation: Press and hold both ▼▲ 3 seconds or auto-exit program mode after 60 seconds inactivity

## 9 PROPORTIONAL CYCLE-TIME

Optimum cycle-time is calculated by Autotune **TUNE** or **TUNE AT SETPOINT** programs, but **not** automatically implemented

The choice of cycle-time is influenced by the external switching device or load, e.g. contactor, SSR, valve

**Note:** A setting that is too long for the process will cause oscillation  
Too short a setting will cause unnecessary wear to an electro-mechanical switching device

### 9.1 ALTERNATIVE CYCLE-TIME SELECTION METHODS

see instructions opposite

**9.1.1** Run Autotune. On completion check the calculated cycle-time, **see 9.4**

- Accept
- Or select nearest suitable value (20 sec factory setting applies unless replaced)

**9.1.2** Pre-select automatic acceptance of **any** calculated Autotune cycle-time, **see 9.5**

**9.1.3** Manually pre-select any cycle-time between 0.1 and 81 sec, this will not be changed, **see 9.6**

**9.1.4** To use the 20 sec factory set cycle-time no action is needed whether Autotune is used or not

Note: When an Autotuned cycle-time **A XX** has been accepted it is automatically updated on each subsequent Autotune

**IF IN DOUBT USE METHOD 1 ABOVE**

## 9.2 **CYC.f** CYCLE-TIME SETTINGS

Analog representation

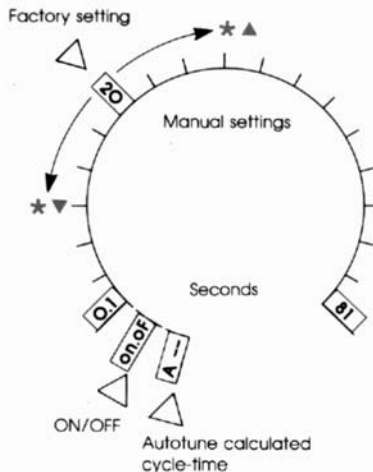

## 9.3 CYCLE-TIME RECOMMENDATIONS

To avoid premature relay failure

Output device	Cycle-time	Load (resistive)
Internal relay <b>rLY</b>	<b>20 sec or more</b>	2A/250V~
	<b>Recommended</b>	
	10 sec minimum	
	5 sec minimum	1A/250V~
Solid state drive <b>SSd</b>	1 – 3 sec typical	SSR
	(Range 0.1–81 sec) 0.1 sec	Logic/PIM

**9.4 TO SELECT AUTOTUNE CALCULATED CYCLE-TIME**

On completion of Autotune

**9.4.1 Enter program mode**

Press and hold both ▼▲ for 3 seconds

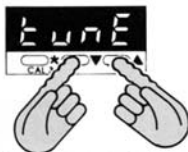

**9.4.2 Index to cycle-time Function**

Press and hold ▲



Release ▲

20 second factory setting displayed



**9.4.3 To view calculated optimum cycle-time**

Press and hold ★ then Press and hold ▼ until indexing stops: e.g. calculated cycle-time is 16 sec  
**If suitable accept**



**9.4.4 Manual selection of more suitable cycle-time**

If the calculated value is not compatible with the switching device e.g. 30 sec more suits a contactor  
Press and hold ★ Press ▲



**9.4.5 Enter the cycle-time in memory**

Press and hold both ▼▲ for 3 sec  
To exit program mode and implement the new instructions



**9.5 TO PRE-SELECT AUTOMATIC ACCEPTANCE OF ANY AUTOTUNE CYCLE-TIME**

**9.5.1 Before Autotune is selected**

Enter program mode, index to cycle-time  
Function **[CYC.t]** see 9.4

**9.5.2 Select Autotune calculated cycle-time**

Press and hold ★ then Press and hold ▼ until indexing stops

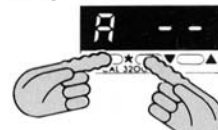

**A --** Shows no Autotune cycle-time yet exists

**9.5.3 Autotune [tunE/on .. /At.SP] must be selected now, BEFORE exiting program mode**

Press and hold ▼ to **[tunE]** Function



**9.6 TO PRE-SELECT CYCLE-TIME BEFORE AUTOTUNE**

**9.6.1 Before Autotune is selected**

Enter program mode Index to cycle-time  
Function **[CYC.t]** see 9.4

**9.6.2 Select preferred value**

Press and hold ★ then Press ▲ to increase (35 sec) or ▼ to decrease



**9.6.3 Either exit program mode**

see 9.4.5 (left), or index to another function

## 10 USING THE SECOND SETPOINT - SP2

### 10.1 TO CONFIGURE SP2 AS AN ALARM

1. Select the main SP2 operating mode in **SP2.A**, see 10.4
2. If required, select a subsidiary SP2 mode in **SP2.b**, see 10.5
3. If the factory set 2.0°C/3.6°F hysteresis is unsuitable, change in **bnd.2**  
Set **CYC.2** ON/OFF (factory setting)
4. Adjust SP2 setpoint in **Set.2** (to set  $y^{\circ}$  in 10.4)
5. Exit program mode - SP2 is now operational as an alarm

### 10.2 TO CONFIGURE SP2 AS A PROPORTIONAL CONTROL OUTPUT

1. Select the main operating mode in **SP2.A**, see 10.4
2. Select SP2 proportional band in **bnd.2** and SP2 cycle-time in **CYC.2**
3. Adjust SP2 setpoint in **Set.2** (to set  $y^{\circ}$  in 10.4)
4. Exit program mode - SP2 is now operational as a control output with time proportioning control action

### 10.3 SP2 IN COOL STRATEGY

For full instructions see separate data:  
'3200 control of heat-cool applications'

Cool strategy Options:

- Cool** in **SP2.A** (Selects cool strategy)  
**nLin** in **SP2.b** (Non-linear proportional band)

### 10.4 **SP2.A** MAIN SP2 OPERATING MODE: ALARMS OR COOL STRATEGY

factory setting **none**

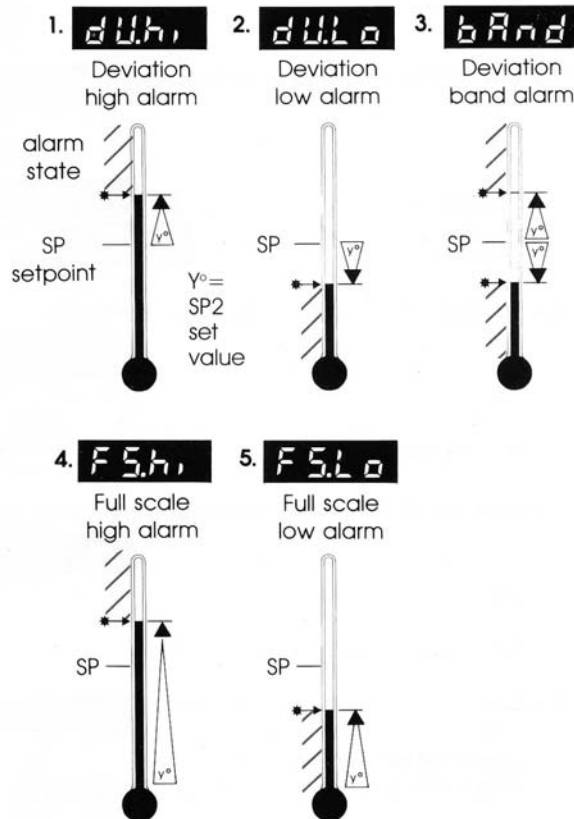



10.5 **SP2.6** SUBSIDIARY SP2 MODE: LATCH/  
SEQUENCE OR NON-LINEAR COOL

factory setting **none**

10.5.1 **Ltch** Latch alarm

When selected the alarm output and indicator latch,  
When the alarm condition has been cleared,  
momentarily press **▼▲** together to reset

10.5.2 **hold** Sequence alarm

When selected, in any alarm mode, prevents an alarm  
on power up. The alarm is enabled only when the  
process temperature reaches setpoint

Example: Sequence alarm used with deviation low  
alarm – **dV.Lo**

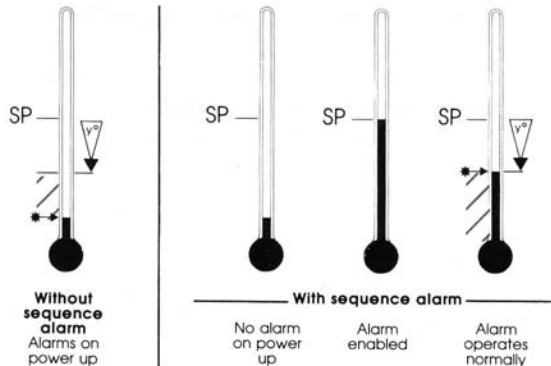

10.5.3 **Ltcho** Latch and sequence alarm

10.6 SP2 OUTPUT AND LED INDICATOR STATES –  
IN ALARM CONDITION

ALARM TYPE	ON-OFF OPERATING MODE		PROPORTIONAL OPERATING MODE	
	SP2 Output state	SP2 LED state	SP2 Output state	SP2 LED state
Deviation <b>dV.hi</b> <b>dV.Lo</b> <b>bAnd</b>			 <b>bAnd</b> : on-off mode only	
Full scale <b>FS.hi</b> <b>FS.Lo</b>				
<b>Cool</b> Strategy	Temperature above setpoint			

- Output ON (Relay or SSd energised)
- Output OFF (Relay or SSd de-energised)
- LED ON

10.7 **-AL-** SP2 ALARM ANNUNCIATOR

When an SP2 alarm mode is selected in **SP2.A** the  
alarm annunciator **-AL-** is displayed, alternating  
with process temperature, during an alarm condition  
(or until reset if the latch alarm is selected)

The annunciator may be disabled see 14  
Function **no.AL** , select Option **on**

## 11.1 RANGING: IMPORTANT SAFETY NOTE

The factory setting of full-scale **hi.SC** is the sensor maximum value, **see 16.2.10** this should be reduced to a safe maximum for the plant or process

### 11.1.1 **hi.SC** full-scale and **Lo.SC** scale minimum

- hi.SC** limits the maximum setpoint adjustment, **Lo.SC** limits the minimum. Both adjust over the full sensor range, including negative
- Factory settings:  
**hi.SC** = sensor maximum, **Lo.SC** =  $0^{\circ}\text{C}/32^{\circ}\text{F}$   
 Reduce **Lo.SC** to set below  $0^{\circ}\text{C}/32^{\circ}\text{F}$
- hi.SC** may not be adjusted below the **Lo.SC** setting, **Lo.SC** not above **hi.SC**

### 11.1.2 Example: Setpoint limited to $400^{\circ}\text{C} - 600^{\circ}\text{C}$

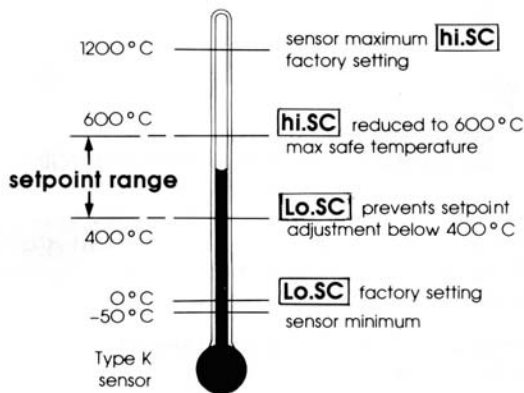

## 11.2 **SP.LK** SETPOINT LOCK

This function in level 1 enables the machine setter to lock the setpoint preventing unauthorised adjustment

## 12 **TOOLS TO IMPROVE CONTROL ACCURACY**

To assist engineers with machine development, commissioning and trouble shooting

### 12.1 **SPI.P** READ SPI OUTPUT PERCENTAGE POWER

Poor control may be due to incorrectly sized heaters. **SPI.P** constantly displays the output percentage power applied, which at normal setpoint should be within 10-80% (preferably 20-70%) to achieve accurate control

### 12.2 **ChEK** CONTROL ACCURACY MONITOR

12.2.1 This enables the accuracy of the temperature control, to within  $0.1^{\circ}\text{C}/^{\circ}\text{F}$ , to be established. The monitor is started using **ChEK** and the variance (deviation), maximum and minimum temperatures are displayed and constantly updated in **REAd**

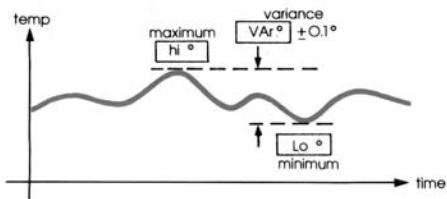

### 12.2.2 Control accuracy monitor: Read outs

### 12.2.3 Using the **ChEK** Control accuracy monitor

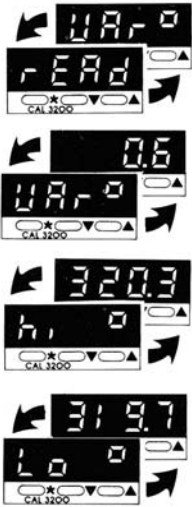
- To start the monitor select **ChEK on**
- During monitoring either return to normal operation or remain in program mode
- To view monitor readings: Index to **rEAd**  
Release ▼ or ▲  

- Press and hold \*  
Displays **variance** (0.6°)
- Hold \* pressed  
Press ▲ once  
Displays **maximum** (320.3°)
- Hold \* pressed  
Press ▲ once more  
Displays **minimum** (319.7°)
- ChEK off** stops monitor, retaining readings  
Next **ChEK on** resets readings
- On de-powering: **ChEK** resets to **off** and **rEAd** zeroed

IMPORTANT NOTE FOR OEM'S: For safety and to protect settings from tampering USE THE SOFTWARE SECURITY LOCK ... THEN REMOVE THIS SECTION

### 13.1 ENTRY TO HIDDEN LEVEL 4

Access to level 4 only at **Ver** in level 3

Press and hold ▼▲ 10 sec  
Hint: Press ▲ to index along level, then ▼ also immediately **Ver** is reached



Enter level 4 at **LoCK**  
Release ▼▲ together  
Factory setting: **nonE**



### 13.2 PROGRAM SECURITY USING **LoCK**

Select from 3 **LoCK** options:

Press and hold \* Press ▲ to index

Locks levels 3 and 4 only  
– TECHNICAL FUNCTIONS



Locks levels 2, 3 and 4 only  
– CONFIGURATION AND  
TECHNICAL FUNCTIONS



Locks all functions \*



### 13.3 NOTES:

- Locked functions and current options may be read
- \* Unrestricted: **LEVEL Ver dAtA SP.LK**

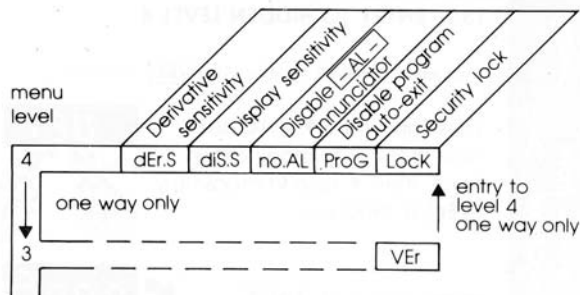

14.(4.1) **dEr.S**  -  x **dEr.t**   
**Derivative sensitivity**

14.(4.2) **di.SS**   -    
**Display sensitivity**  
 = Direct display of input  
 = Maximum  = Minimum sensitivity

14.(4.3) **no.AL**    
**Disable SP2 Alarm annunciator**   
 Select  to disable

14.(4.4) **ProG**    
**Program mode auto-exit switch**  
 Auto-exit returns display to normal if 60 sec key inactivity. Select  to disable

14.(4.5) **LoCK**      
**Program security lock, see 13.2**

15.1 Sensor fault

Thermocouple burnout  
 RTD/Pt100 short circuit  
 Negative over-range

**Action:** Check sensor/wiring



15.2 Non-volatile memory error

**Action:** De-power briefly  
 Replace unit if it persists



15.3 Manual power error

SP1 in ON/OFF in

**Action:** Select proportional mode



15.4 Immediate fail on Autotune start

1. Setpoint unset on new unit
2. SP1 at ON/OFF in

Select proportional mode

**Note:** Message latches  
 Press   briefly to reset



15.5 Fail during Autotune tuning cycle

The thermal characteristics of the load exceed the Autotune algorithm limits. The failure point is the first display in  with

**Action:**

1. Change the conditions, e.g. raise setpoint
2. Try   see 7.2.3
3. Check  percentage power, see 12.1
4. **If the error message persists, call CAL for advice**

**15.6 Reading Autotune tuning cycle results in **dAtA****

1. Index to **dAtA**  
Release  $\nabla$  or  $\blacktriangle$
2. Press and hold **\***  
Displays **Ct A** value (10.4)  
i.e. Cycle time 'A' = 10.4 sec
3. Keep **\*** pressed  
Press  $\blacktriangle$  once  
Displays **Ct b** value (19.6)  
i.e. Cycle time 'b' = 19.6 sec
4. Repeat step 3 above to view:  
**Ct 1 Ct 2 Ct 3 Ct 4** , **oS 1 uS oS 2**

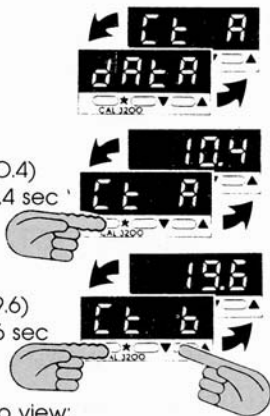

**15.7 Autotune tuning data and limits**

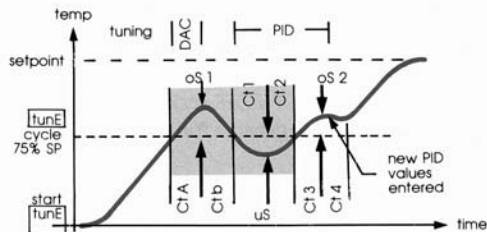

**Autotune limits**

**Ct** (Quarter cycle time): 1 – 1800 sec/30 min  
**oS** (Overshoot) } max 255° C/490° F  
**uS** (Undershoot) }

**SELECT AUTOTUNE**

16(1.1) **tunE** **oFF** **on** **PARk** **At.SP**

Select Autotune, see 7, or **PARk**

**PARk** temporarily turns the output(s) off. To use, select **PARk** and exit program mode. **oFF** disables Useful when commissioning fast loads or multizones

**SPI OPERATING PARAMETERS**

16(1.2) **bAnd** **0.1** – **\*** °C/°F **10°C/18°F**

**SPI Proportional band/Gain or Hysteresis**  
 \* 25% sensor maximum

Proportional control eliminates the cycling of on-off control. Heater power is reduced, by time proportioning action, across the proportional band



**Too narrow**  
 (oscillates)  
 Increase **bAnd**



**Too wide**  
 (slow warm up and response)  
 Decrease **bAnd**

16(1.3) **intE** **oFF** **0.1** – **60** minutes **5.0**

**SPI Integral time/Reset**

Auto-corrects proportional control offset error



**P20** **Too short**  
 (overshoots and oscillates)



**Too long**  
 (slow warm up and response)

## 16 FUNCTIONS AND OPTIONS: LEVEL 1

16(1.4) **der.t** **OFF** **1** - **200** seconds **25**

### SP1 Derivative time/Rate

Suppresses overshoot and speeds response to disturbances



**Too short**  
(slow warm up and response, under corrects)



**Too long**  
(oscillates and over corrects)

16(1.5) **dac** **0.5** - **5.0** x **bAnd** **1.5**

### SP1 Derivative approach control ... DAC

Tunes warm up characteristics, independent of normal operating conditions, by controlling when derivative action starts during warm up (smaller **dac** value = nearer setpoint)



**Too small**  
(overshoots)



**Too large**  
(slow stepped warm up)

16(1.6) **cycle** **A--** **on.oF** **0.1** - **81** secs **20**

### SP1 Proportional cycle-time, see 9

Determines the cycle rate of the output device for proportional control. Select **on.oF** for ON/OFF mode



**Ideal**



**Too long**  
(oscillates)

16(1.7) **oFSt** **0** - **\*** °C/°F

### SP1 Offset/Manual reset

\* ± 50% **bAnd**. Applicable in proportional and ON/OFF mode with integral disabled: **Int.t / oFF**

16(1.8) **SPLY** **oFF** **on**

**Lock main setpoint, see 11.2**

## SP2 OPERATING PARAMETERS

16(1.9) **SEt2** **0** - **\*** °C/°F

**Adjust SP2 setpoint, see 10**

\* Deviation alarms **DV.hi** **DV.Lo** **bAnd** : 25% sensor maximum

\* Full-scale alarms **FS.hi** **FS.Lo** : sensor range

16(1.10) **band2** **0.1** - **\*** °C/°F **2.0°C/3.6°F**

**Select SP2 hysteresis or Proportional band/ Gain**

\* 25% sensor maximum

16(1.11) **cycle2** **on.oF** **0.1** - **81** seconds

**Select SP2 ON/OFF or Proportional cycle-time**

Select **on.oF** for ON/OFF mode or the cycle rate of SP2 output device for proportional mode

**MANUAL CONTROL MODES**

- 16(2.1) **SP1P**  - **100** % 'Read only'  
Read SP1 output percentage power, see 12
- 16(2.2) **hRNd**  OFF **1** - **100** % (Not in ON/OFF)  
SP1 manual percentage power control  
For manual control should a sensor fail  
Record typical **SP1.P** values beforehand
- 16(2.3) **PL1** **100** -  % duty cycle  
Set SP1 power limit percentage  
Limits max SP1 heating power during  
warm up and in proportional band
- 16(2.4) **PL2** **100** -  % duty cycle  
Set SP2 percent power limit (cooling)

**SP2 OPERATING MODES, see 10**

- 16(2.5) **SP2A** Main SP2 operating mode  
 nonE  dV.hi  dV.Lo  bAnd  
 FS.hi  FS.Lo  Cool
- 16(2.6) **SP2b**  nonE  LtCh  hoLd  Lt.ho  nLin  
Subsidiary SP2 mode: latch/sequence  
Non-linear cool proportional band

**INPUT SELECTION AND RANGING**

- 16(2.7) **dISP** **1**  0.1 °  
Select display resolution: 0.1° display of  
PV, SP,  OFSt  SET.2  hi.SC  Lo.SC
- 16(2.8) **hISC**  sensor  sensor  
 minimum  maximum °C/°F  
Set full scale, see 11.1
- 16(2.9) **LoSC**  sensor  sensor  
 minimum  maximum °C/32°F  
Set scale minimum, see 11.1

16(2.10) **inPt** Select input sensor  nonE

**Option/  
sensor type sensor range linearity**

**Thermocouples**

			linearity		
			+°C		
tc b	B	0 to 1800 °C	32 to 3272 °F	Pt-30%Rh/Pt-6%Rh	2.0 *
tc E	E	0 to 600 °C	32 to 1112 °F	Chromel/Con	0.5
tc J	J	0 to 800 °C	32 to 1472 °F	Iron/Constantan	0.5
tc K	K	-50 to 1200 °C	-58 to 2192 °F	Chromel/Alumel	0.25*
tc L	L	0 to 800 °C	32 to 1472 °F	Fe/Konst	0.5
tc n	N	-50 to 1200 °C	-58 to 2192 °F	NiCroSil/NiSil	0.25*
tc r	R	0 to 1600 °C	32 to 2912 °F	Pt-13%Rh/Pt	2.0 *
tc s	S	0 to 1600 °C	32 to 2912 °F	Pt-10%Rh/Pt	2.0 *
tc t	T	-200 / 250 °C	-273 / 482 °F	Copper/Con	0.25*

**Resistance thermometer**

rtd	-200 / 400 °C	-273 / 752 °F	Pt100/RTD-2'	0.25*
-----	---------------	---------------	--------------	-------

**Linear process inputs** (Input mV range: -10 to 50mV)

displays	0-20mV	4-20mV	setpoint limits	
Lin1	0 - 100		0 - 400	} ±0.5%
Lin2		0 - 100	-25 - 400	
Lin3	0 - 1000		0 - 3000	
Lin4		0 - 1000	-250 - 3000	
Lin5	0 - 2000		0 - 3000	

**Notes:**

- Linearity: 5-95% sensor range
- \*Linearity B:5°(70° - 500 °C)/K/N: 1°>350 °C  
exceptions: R/S:5°<300 °C T: 1°<-25°>150 °C  
RTD/Pt100: 0.5°<-100 °C
- Optional PIM Process Interface Module provides additional input/output options

16(2.11) **unIt**  nonE  °C  °F  bAr  PSi  Ph  rh

**Select °C/°F or process units**

Processor calculates in °C, when °F converts  
functions marked °C/°F (Process units  
calculate as °C)

## 16 FUNCTIONS AND OPTIONS: LEVEL 3

### OUTPUT CONFIGURATION

- 16(3.1) **SP1.d**  nonE  rLY  SSd  
**Select SP1 output device, see 5.3/6.2.4**  
**Note:** 'Read only' after initial configuration.  
 RSEt  ALL full reset to factory settings  
 required to change  SP1.d subsequently

- 16(3.2) **SP2.d**  nonE  SSd  rLY 'Read only'  
**Read SP2 output device, see 5.3/6.2.4**  
 Shows SP2 output device

### TECHNICAL FUNCTIONS

- 16(3.3) **burn** **Sensor burn-out/break protection**

**Caution:** Setting affects fail safe state

	SP1	SP2
<input type="checkbox"/> uP.SC	Upscale	Upscale
<input type="checkbox"/> dn.SC	Downscale	Downscale
<input type="checkbox"/> 1u.2d	Upscale	Downscale
<input type="checkbox"/> 1d.2u	Downscale	Upscale

- 16(3.4) **rEULd** **Select output modes:**  
**Direct/Reverse**

**Caution:** Setting affects fail safe state

	SP1	SP2
<input type="checkbox"/> 1r.2d	Reverse	Direct
<input type="checkbox"/> 1d.2d	Direct	Direct
<input type="checkbox"/> 1r.2r	Reverse	Reverse
<input type="checkbox"/> 1d.2r	Direct	Reverse

Select **Reverse** on SP1 for heating and  
**Direct** for cooling applications

- 16(3.5) **rEUL** **Select SP1/2 LED indicator modes**

	SP1	SP2
<input type="checkbox"/> 1n.2n	Normal	Normal
<input type="checkbox"/> 1i.2n	Invert	Normal
<input type="checkbox"/> 1n.2i	Normal	Invert
<input type="checkbox"/> 1i.2i	Invert	Invert

- 16(3.6) **SPAN**  O.O -  ±25% sensor maximum  
**Sensor span adjust**  
 For recalibrating to a remote standard  
 e.g. External meter, data logger

- 16(3.7) **ZEro**  O.O -  ±25% sensor maximum  
**Zero sensor error, see  SPAn**

- 16(3.8) **ChEV**  OFF  on  
**Select control accuracy monitor, see 12.2**

- 16(3.9) **rEAd**  VAr°  hi°  Lo°  
**Read control accuracy monitor, see 12.2**

- 16(3.10) **dAtA**  Ct A  Ct b  Ct 1  Ct 2  
 Ct 3  Ct 4  oS 1  uS  oS 2  
**Read Autotune tuning cycle data, see 15**

- 16(3.11) **VER** **Software version number**

- 16(3.12) **rSEt**  nonE  ALL  
**Resets all functions to factory settings**  
**Caution:** Note current configuration **BEFORE**  
 using this function, **see 18**, initial configuration  
 and OEM settings must be re-entered



**INPUTS, see 16(2.10)**

**Thermocouple – 9 types**

Standards: IPTS 68/DIN 43710  
CJC rejection: 20:1 (0.05° / °C) typical  
External resistance: 100Ω maximum

**Resistance thermometer:** RTD-2/Pt100 2 wire  
Standards: DIN 43760 (100Ω 0 °C/138.5Ω 100 °C Pt)  
Bulb current: 0.2mA maximum

**Linear process inputs:** mV range: -10 to 50mV  
See "PIM Process Interface Module" for additional input/output options

**Applicable to all inputs:** SM = sensor maximum  
Calibration accuracy:  $\pm 0.25\% SM \pm 1^\circ C$   
Sampling frequency: Input 10Hz, CJC 2 sec  
Common mode rejection: Negligible effect up to 140dB, 240V, 50-60Hz  
Series mode rejection: 60dB, 50-60Hz  
Temperature coefficient: 150 ppm/ °C SM  
Reference conditions: 22 °C  $\pm 2^\circ C$ , rated voltage, after 15 minutes settling time

**OUTPUT DEVICES (Standard), see 5.3**

- **SSd:** Solid state relay drive: To switch a remote SSR 5Vdc +0/-15% 10mA non-isolated
- **Miniature power relay:** Form A/SPST contacts (AgCdO) 2A/250V~ resistive load

**COOL CHANNEL when cool strategy selected**

See separate data:

**3200 control of heat-cool applications**

**CONTROL CHARACTERISTICS See 16:**

**SP1 PID Parameters:** 16(1.1) – 16(1.8)  
**SP2 Parameters:** 16(1.9) – 16(1.11)  
**SP2 Operating modes:** 16(2.5) – 16(2.6)  
**Manual control modes:** 16(2.1) – 16(2.4)

**GENERAL**

Supply Voltage: 100-240V $\pm 10\%$  50-60 Hz 3VA  
12V or 24V =  $\pm 20\%$  3VA  
Digital LED display: 4 digits, 10mm (0.4in), high brightness green, Display range: -199 to 9999  
Range: Sensor limited: 2000°C/3500°F  
0.1 hi-res mode -199.9 to 999.9°  
Process temperature (PV), Setpoint (SP), SP1/2 indicators (flashing), Error messages.  
Function/Option mnemonics  
Keypad: 3 Elastomeric buttons

**ENVIRONMENTAL Approvals**

Safety: UL873, CSA 22.2/142-87, EN61010  
Humidity: Max. 80%  
Altitude: Up to 2000M  
Installation: Categories II and III  
Pollution: Degree II  
Protection: NEMA 4X, IP66  
EMC Emission: EN 50 081-1, VDE 0871/78-Class A & B  
FCC Rules 15 subpart J Class A  
EN50082-1 RF Field Test:  
EMC Immunity: <200 MHz 1%FS >200 MHz 5% FS  
Ambient: 0-50 °C (32-130°F)  
Mouldings: Flame retardant polycarbonate  
Weight: 100g (3.5ozs)

SER No.						
LEVEL	DATE ▶	/	/	/	/	/
1.	bAnd					
	int.t					
	dEr.t					
	dAC					
	CYC.t					
	SEt.2					
	bnd.2					
	CYC.2					
2.	SP1.P					
	SP2.A					
	SP2.b					
	hi.SC					
	Lo.SC					
	inPt					
	unit					
3.	SP1.d					

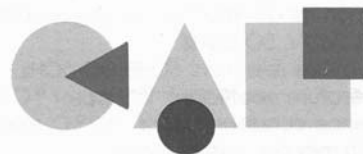

**CAL Controls**  
Temperature Controllers



**CAL Controls Ltd**  
Bury Mead Road, Hitchin, Herts, SG5 1RT, UK  
Tel: +44 (0) 1462-436161 Fax: +44 (0) 1462-451801

**CAL Controls Inc**  
1580 S. Milwaukee Avenue, Libertyville. IL 60048  
Tel: (847) 680-7080 Fax: (847) 816-6852