



Read this document carefully before using this device. The guarantee will be expired by damaging of the device if you don't attend to the directions in the user manual. Also we don't accept any compensations for personal injury, material damage or capital disadvantages.

CAL ET2011 PID TEMPERATURE CONTROLLER

Thank you for choosing CAL ET2011 temperature controller.

- * 77 x 35mm sized.
- * Selectable dual setpoint.
- * Selectable thermocouple types or PT100 input. (Specify at order).
- * Automatic calculation of PID parameters. (SELFTUNE).



Selftune for automatic PID calculation or manually enter PID parameters if known.

- * Soft-Start feature.
- * Zero point input shift.
- * C/A2 Relay output programmable as alarm or control output.
- * Selectable SSR control output.
- * Selectable heating/cooling control.
- * In the case of sensor failure, manual control can be selected.
- * CE marked according to European Norms.



RoHS
Compliant

TECHNICAL SPECIFICATIONS

Input type	Temperature range		Accuracy
	°C	°F	
PT100 Resistance thermometer EN 60751	-99.9...300.0 °C	-99.9...543.0 °F	± 0,5% (of full scale) ± 1 digit
PT100 Resistance thermometer EN 60751	-200...600 °C	-328...1112 °F	± 0,5% (of full scale) ± 1 digit
J (Fe-CuNi) Thermocouple EN 60584	0... 600°C	+32... +1112°F	± 0,5% (of full scale) ± 1 digit
K (NiCr-Ni) Thermocouple EN 60584	0...1300°C	+32... +2372°F	± 0,5% (of full scale) ± 1 digit
T (Cu-CuNi) Thermocouple EN 60584	0... 400°C	+32... +752°F	± 0,5% (of full scale) ± 1 digit
S (Pt10Rh-Pt) Thermocouple EN 60584	0...1700°C	+32... +3092°F	± 0,5% (of full scale) ± 1 digit
R (Pt13Rh-Pt) Thermocouple EN 60584	0...1700°C	+32... +3092°F	± 0,5% (of full scale) ± 1 digit

ENVIRONMENTAL CONDITIONS

Ambient/storage temperature	0 ... +50°C/-25... +70°C (with no icing)	
Max. Relative humidity	80% Relative humidity for temperatures up to 31°C, decreasing linearly to 50% at 40°C.	
Rated pollution degree	According to EN 60529	Front panel : IP65 Rear panel : IP20
Height	Max. 2000m	



Do not use the device in locations subject to corrosive and flammable gases.

ELECTRICAL CHARACTERISTICS

Supply	230V AC +%10 -%20, 50/60Hz or 24V AC %±10, 50/60Hz
Power consumption	Max. 5VA
Wiring	Power connector: 2.5mm ² screw-terminal, Signal connector: 1,5mm ² screw-terminal connection.
Line resistance	Max. 100ohm
Data retention	EEPROM (minimum 10 years)
EMC	EN 61326-1: 2006
Safety requirements	EN 61010-1: 2010 (Pollution degree 2, overvoltage category II)

OUTPUTS

C/A2 output	Relay : 250V AC, 8A (for resistive load), Selectable as NO+NC Control or Alarm2 output. Relay : 250V AC, 16A (for resistive load), Selectable as NO Control or Alarm2 output.
SSR output	Max 20mA 12Volt (as control output)
Life expectancy for relay	Without load 30.000.000 mechanical operation; 250V AC, on the 8A resistive load 100.000 electrical switching

CONTROL

Control type	Single set-point and alarm control
Control algorithm	On-Off / P, PI, PD, PID (selectable)
A/D converter	12 bit
Sampling time	100ms
Proportional band	Adjustable between 0% and 100%. If Pb=0%, On-Off control is selected.
Control period	Adjustable between 1 and 250 seconds
Hysteresis	Adjustable between 1 and 50°C/F
Output power	The ratio of power at a set point can be adjusted between 0% and 100%

HOUSING

Housing type	Suitable for flush-panel mounting according to DIN 43 700.
Dimensions	W77xH35xD71mm
Weight	Approx. 200g (after packing)
Enclosure material	Self extinguishing plastics.



While cleaning the device, solvents (thinner, benzene, acid etc.) or corrosive materials must not be used.



(01943) 602001

@ sales@issltd.co.uk

www.issltd.co.uk

Entering from the programming mode to the run mode:
 If no key is pressed within 20 seconds during programming mode, the data is stored automatically and the run mode is entered.

Alternatively, the same function occurs first pressing \blacktriangle key and \blacktriangledown key is pressing programming mode is entered. Then \blacksquare and \blacktriangle keys are pressing together, data is recorded and running mode is entered.

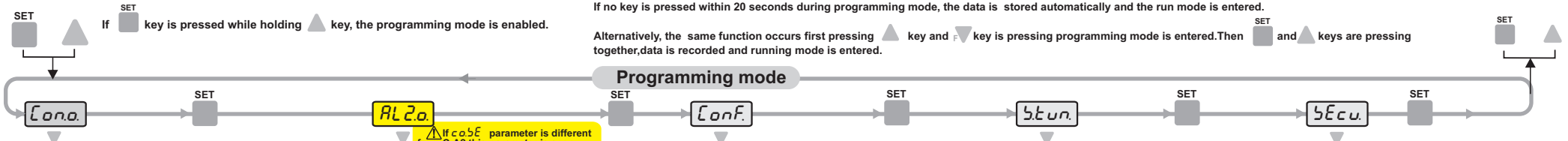

C.S.L.o. C.S.L.o = Control set point lower limit.(for selected output)
 Adjustable between 0 and C.S.H.i.

C.S.H.i. C.S.H.i = Control setpoint upper limit.(for selected output)
 Adjustable between C.S.L.o and Upper scale value.

C.P.b. C.P.b = Proportional band.(for selected output)
 Adjustable between %0.0 and %100.0.
 C.P.b = %0.0, On-Off control is selected.

C.H.Y.S. C.H.Y.S = Hysteresis of the output.(for selected output)
 Adjustable between 1 and 50 °C.
 \blacktriangle C.P.b = 0, this parameter is active.

C.t.i. C.t.i = Integral time.(for selected output)
 Adjustable between 0 and 100.0 minutes.
 C.t.i = 0.0, integral impact is disable.
 \blacktriangle C.P.b parameter is different from "0", this parameter appears.

C.t.d. C.t.d = Derivative time.(for selected output)
 Adjustable between 0.00 and 25.00 minutes.
 C.t.d = 0.0, derivative time is disabled.
 \blacktriangle C.P.b parameter is different from "0", this parameter appears.

C.t.e. C.t.e = Period time.(for selected output)
 Adjustable between 1 and 250 second.
 \blacktriangle C.P.b parameter is different from "0", this parameter appears.

C.P.s.t. C.P.s.t = The ratio of output power at the setpoint. Adjustable between %0 and %100.

C.E.P.s. C.E.P.s = The percentage of faulty sensor selected output power. Adjustable between %0 and %100.

S.S.t.s. S.S.t.s = Soft starter timer set value
 This parameter indicates the time to reach set point value when the device is first energised.
 Adjustable between 0 and 250 minutes.
 If 0 is selected, soft start feature will be enable and the device reaches set point value quickly.
 \blacktriangle Setting Pb = 0, soft start feature will be disabled.

C.t.Y.P. C.t.Y.P = Control output type
 C.t.Y.P = HEAT means heating control.
 C.t.Y.P = COOL means cooling control.

R2.S.L. R2.S.L = Alarm2 set value lower limit.
 Adjustable between 0 and R2.S.H. parameter value.

R2.S.H. R2.S.H = Alarm2 set value upper limit.
 Adjustable between R2.S.L parameter value and upper scale value.

R2.H.Y. R2.H.Y = Hysteresis of the Alarm2 output.
 Adjustable between 1 and 50 °C.

R2.t.P. R2.t.P = Function of Alarm2 type.
 Four kinds of functions can be selected.
 i.n.d.E = Independent alarm (Independent)
 d.E = Deviation
 b.A.n.d = Band alarm (Band)
 b.A.n.i = Band with inhibition

R2.S.E. R2.S.E = The state of Alarm2 output.
 H = If A2 output is above the set value. (on)
 L = If A2 output is above the set value. (off)

R2.E.r. R2.E.r = State of Alarm2 output in the case of sensor failure.
 on = A2 output is probe failure (on).
 off = A2 output is probe failure (off).

i.n.P.t. i.n.P.t = Input type selection.
 F.E.C.n = J type, i.n.c.n.R = K type, c.c.n = T type
 P.I.D.r = S type, P.I.R = R type thermocouple selection.
 \blacktriangle This parameter varies when changing some parameters.

U.n.i.t. U.n.i.t = The temperature unit.
 o.C = °C, o.F = °F
 \blacktriangle (This parameter varies when changing some parameters.)

F.L.t.r. F.L.t.r = Coefficient of digital filter.
 Filter for display value.
 Adjustable between 1 and 200. If this parameter is 1, the filter run most slow. The value of parameter should be increased in interference.

C.o.S.E. C.o.S.E = Control output selection
 C-A2 = CIA2 (Relay) output selection
 SSR = SSR output selection

o.F.F.s. o.F.F.s = Offset value.
 Offset value is added to the measurement value.
 Adjusted between -100 and +100 °C. The normal value is 0.

F.F.E.C. F.F.E.C = Function key setting parameter
 n.o.n.E = Function key is off.
 C.2.S.R = The function key with 2.set value is used.
 n.A.R.n.u = Manual mode can be achieved with the function key.
 d.S.P.o = Only the temperature display mode is entered with function key.

n.s.E.t. n.s.E.t = The percentage of manual output parameter.
 Adjustable between %0 and %100.
 This parameter allows manual adjustment of the output power when the manual output selection.
 \blacktriangle C.P.b = 0, this parameter is not seen.

S.t.C.o. S.t.C.o = Self tune control parameter.
 If both \blacksquare and \blacktriangle keys are pressed, Y.P.S message is displayed on the screen and selftune process is started automatically.

If both \blacksquare and \blacktriangledown keys are pressed, n.o message is displayed on the screen and selftune process is stopped.

When the self tune begins, P.i.d.t. message and measurement value are shown alternately.
 After the completion of the self tune process, S.t.C.o. parameter is automatically changed to n.o and the device returns to working mode.
 If the measured temperature is higher than 90% of the set value at the beginning of the self tune process, then t.E.H.i. message is shown alternately and the measured temperature is waited to go below %60 of the set value. After that, self tune operation is started automatically.
 If it is intended to abort the self tune process, S.t.C.o. parameter is changed to n.o and \blacktriangledown key is pressed.

S.C.o.d. S.C.o.d = Security menu access code.
 It should be 2011.

C.o.s.c. C.o.s.c = Parameters of C.o.n.o. menu security access level code.
 n.o.n.E = Invisibile.
 P.Y.E.s = Modification can be done.
 P.n.o = Only visible.

R2.S.c. R2.S.c = Parameters of R2.o. menu security access level code.
 n.o.n.E = Invisibile.
 P.Y.E.s = Modification can be done.
 P.n.o = Only visible.

C.n.s.c. C.n.s.c = Parameters of C.o.n.f. menu security access level code.
 n.o.n.E = Invisibile.
 P.Y.E.s = Modification can be done.
 P.n.o = Only visible.

S.t.S.c. S.t.S.c = Parameters of S.t.u.n. menu security access level code.
 n.o.n.E = Invisibile.
 P.Y.E.s = Modification can be done.

d.E.F.P. d.E.F.P = Parameters of C.o.n.f. menu security access level code.
 n.o = Parameter settings are not change.
 Y.E.s = Parameter setting will be restored.

\blacktriangle While the parameter names appear, if \blacktriangle and \blacktriangledown keys are pressed together, returns to the program mode.

DEFAULT PARAMETERS

Set parameters	Control output parameters		Alarm2 output parameters		Configuration parameters		Self tune parameters		Security parameters	
	TC input	PT100 input	TC input	PT100 input	TC input	PT100 input	TC input	PT100 input	TC input	PT100 input
C.S.L.o	0	-200	R2.S.L	0	-200	i.n.P.t	F.E.C.n	P.t	R2.E.r	n.o
C.S.H.i	600		R2.S.H	600		U.n.i.t	o.C		C.o.s.c	P.Y.E.s
C.P.b	0		R2.H.Y	2		F.L.t.r	25		R2.S.c	P.Y.E.s
C.H.Y.S	2		R2.t.P	i.n.d.E		C.o.S.E	C-A2		S.t.S.c	P.Y.E.s
C.t.i	4.0		R2.S.E	H		o.F.F.s	0		d.E.F.P	n.o
C.t.d	1.00		R2.E.r	o.n		F.F.E.C	n.o.n.E			
C.t.e	20					n.s.E.t	50			
C.P.s.t	0									
C.E.P.s	0									
S.S.t.s	0									
C.t.Y.P	HEAT									

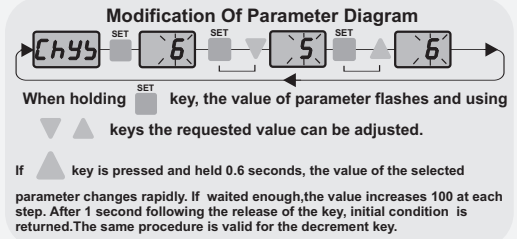

TERMS

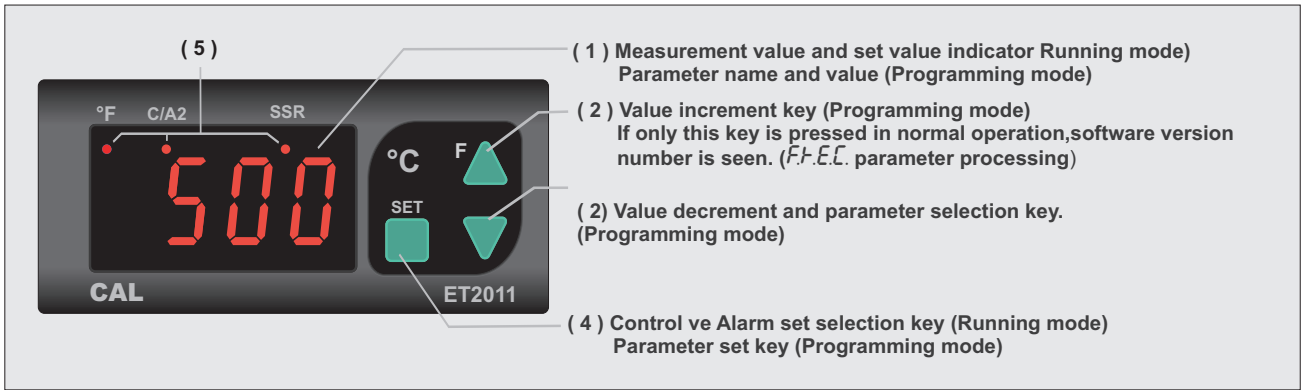

(1) PV and SV display	7 segment, 4 digits red LED display
Character heights	12 mm
(2),(3),(4) Keypad	Micro switch
(5) State indicator	For control, Alarm1 and SSR outputs 3 digits red LED

ALARM2 OUTPUT TYPES

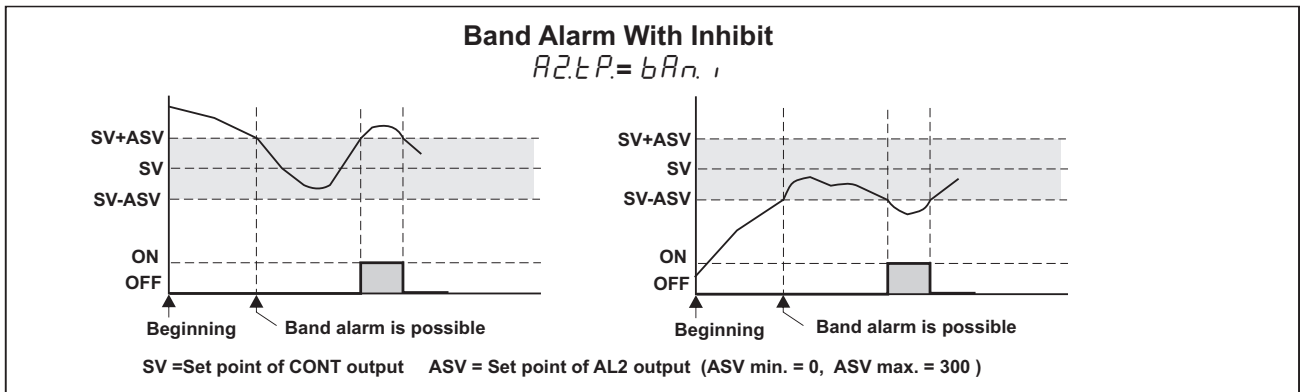
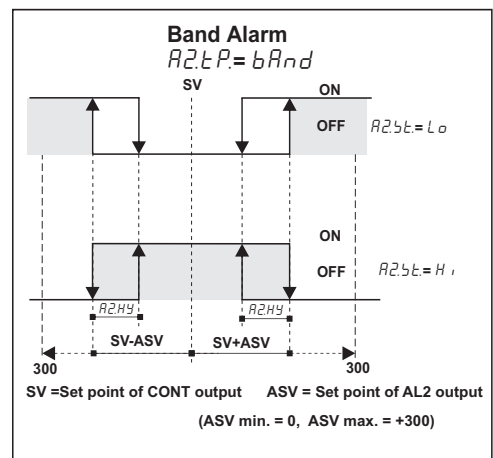
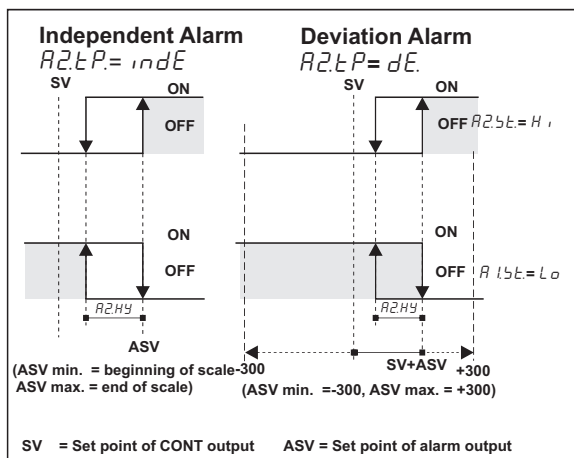

MODIFICATION OF CONTROL AND ALARM SET POINTS

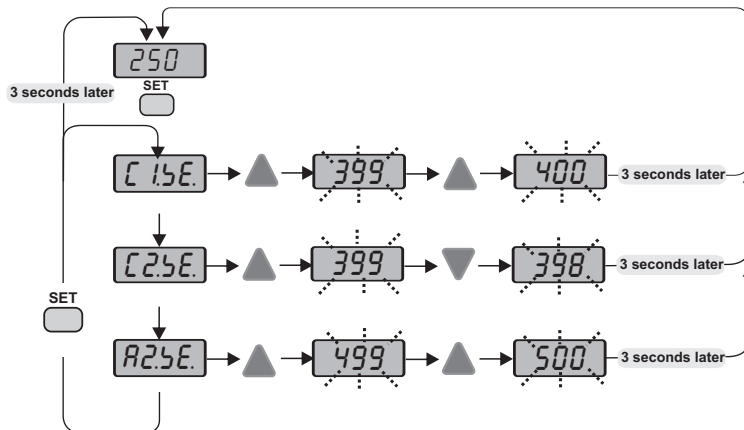

ERROR MESSAGES

- PFR** Sensor is broken
- Temperature value is higher than the value
- Temperature value is lower than the scale
- P5C** PT100 sensor is short circuit

F.F.E.C. parameter, is set to the C25R parameter, this parameter is displayed.

C25E parameter is set to the output of SSR, this parameter is seen.

DIMENSIONS



For removing mounting clamps ;
 - Push flush mounting clamps in direction 1 as shown in the figure below.
 Then pull out the clamps in direction 2 .

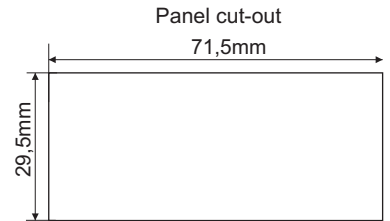
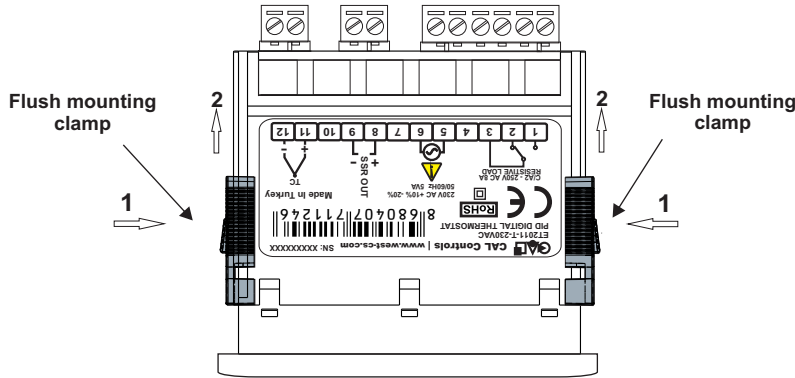
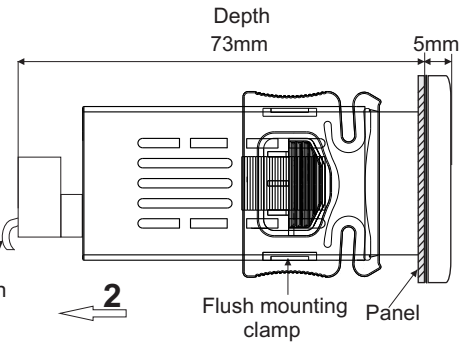

Note :
 1) Panel thickness should be maximum 7mm.
 2) If there is no 60mm free space at back side of the device, it would be difficult to remove it from the panel.

Order Code : ET2011---
 1 2 3

1- Input selection
 RT....PT100 input
 T....TC input

2 - Supply Voltage
 230VAC...230V AC
 110VAC....110V AC
 024VAC.....24V AC
 SM.....9-30V DC / 7-24V AC

3- Contact current selection
 None.....8A contact output
 P....16A contact output

CONNECTION DIAGRAM



CAL ET2011 is intended for installation within control panels. Make sure that the device is used only for intended purpose. The shielding must be grounded on the instrument side. During an installation, all of the cables that are connected to the device must be free of electrical power. The device must be protected against inadmissible humidity, vibrations, severe soiling. Make sure that the operation temperature is not exceeded. All input and output lines that are not connected to the supply network must be laid out as shielded and twisted cables. These cables should not be close to the power cables or components. The installation and electrical connections must be carried out by a qualified staff and must be according to the relevant locally applicable regulations.

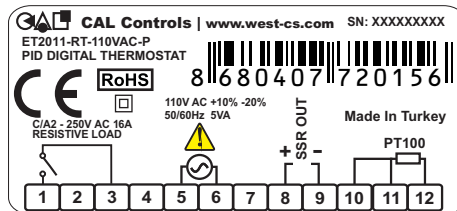
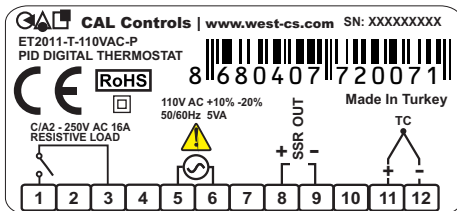
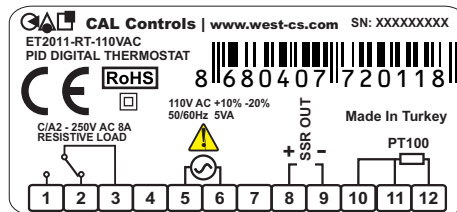
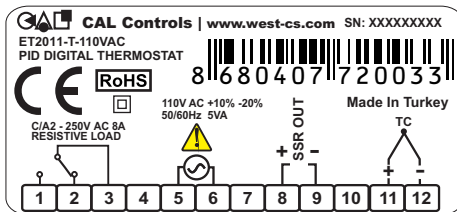

Holding screw 0.4-0.5Nm

Equipment is protected throughout by DOUBLE INSULATION.

NOTE :
 SUPPLY:



Note 1) Mains supply cords shall meet the requirements of IEC 60227 or IEC 60245.
 2) In accordance with the safety regulations, the power supply switch shall bring the identification of the relevant instrument and it should be easily accessible by the operator.