

SR100A

100 mm Advanced Process Recorder

SR100A – simplicity with power

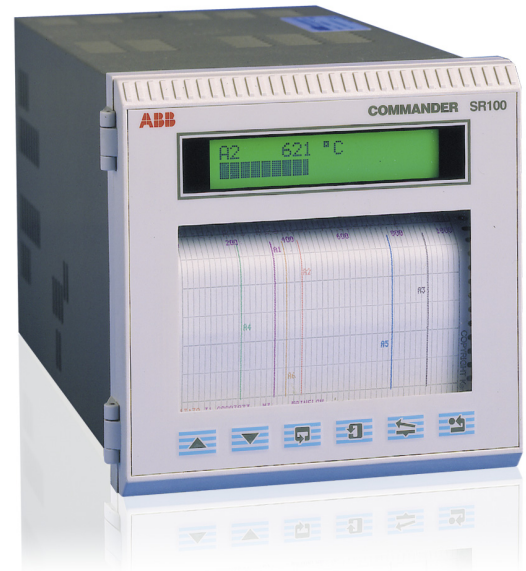

1- to 6-trace recording on a 100 mm chart

– continuous intelligent traces on a common time base

Precision universal process inputs

– accepts thermocouples, RTDs, mA, mV and V

Unique Cue and Review incident analysis

– historical data at the touch of a button

High clarity LCD display

– clear message display and text prompts

Totalizers, math and logic equations

– advanced processing capabilities, soft wiring for extended functionality

RS485 Modbus™ serial communications

– provides full integration with your control system

Dust and water resistant to IP65 (NEMA3) front fascia

– for hosedown industrial environments

Direct configuration and logging on PC

– dedicated configuration software, datalogging to memory card



SR100A
100 mm Advanced Process Recorder

SR100A

The SR100A is a 100 mm strip chart recorder providing accurate and reliable recording of up to 6 channels. The **SR100A** also provides a range of advanced processing capabilities, such as flow totalization, math blocks, logic equations, configurable displays and full message printing, that can be configured via the front panel facia or PC Configurator software.

When fitted with the optional **PC memory card** data storage, **RS485 MODBUS** communication and up to 12 alarm relays, the recorder becomes a very powerful signal processing tool.

To assist the operator in analyzing any process problem, the **SR100A** has a unique patented **Cue-and-Review** system, allowing the user to examine historical data anywhere on the chart at the push of a button.

The **SR100A** can be supplied either for panel mounting or for portable use. The front facia, rated IP65 (NEMA3), is resistant to hosedown and dusty environments.

Application areas include:

- Furnaces
- Water treatment plants
- Cold stores
- Stack gas monitoring
- Sterilizer surveys
- Laboratories

Process Connections

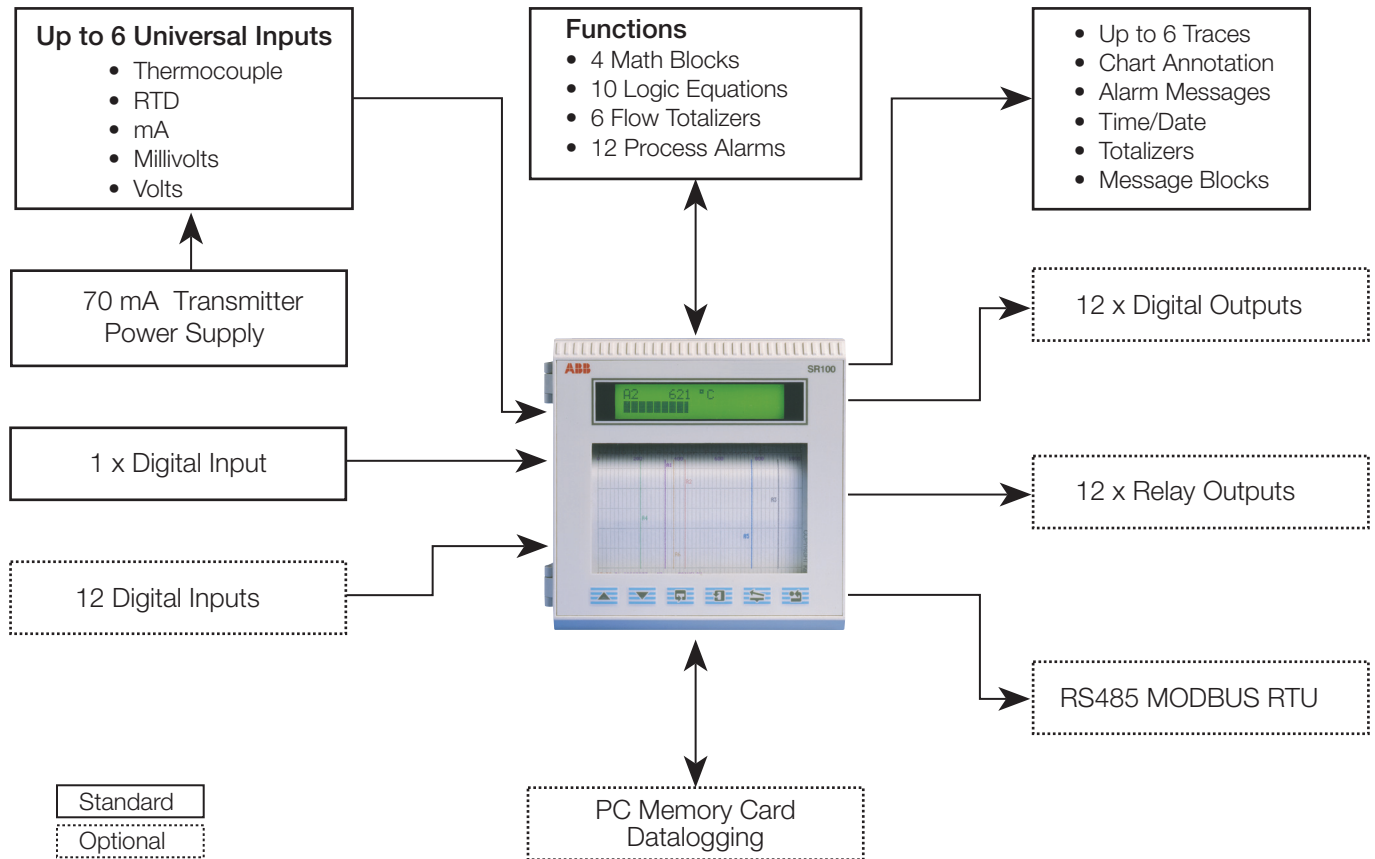

SR100A
100 mm Advanced Process Recorder

Operation

A graphic liquid crystal display (LCD) provides a choice of five different display formats to suit the application.

During normal operation the display cycles through each channel in sequence.

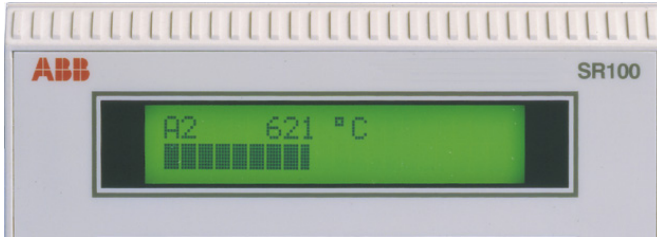

Clear text prompts on the display assist the operator in accessing functions such as chart reload and alarm acknowledge using membrane keys on the front of the recorder.

Password protection prevents unauthorized access to the recorder's configuration.

Quickly-fitted pen cartridges and an easily-removable chart cassette ensure simple and efficient pen and chart replacement.

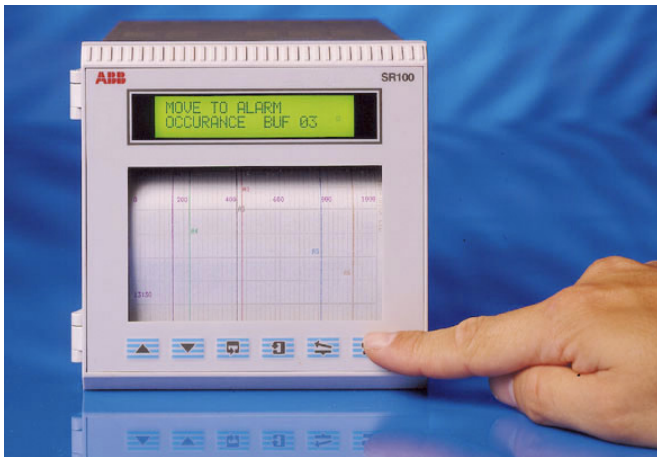

Unique Post-Incident Analysis (Cue-and-Review)

The **SR100A** allows the user to quickly rewind to any part of the roll chart for process event or alarm occurrence – enabling rapid and accurate analysis of process records.

The **SR100A** can be configured to monitor up to 12 user-defined process alarms and two real-time clock alarms.

The 10 most recent alarms are held in a buffer, allowing the user to examine the order of process incidents and to review that part of the chart for analysis and evaluation.

Set-up

The SR100A can be easily set up to match your process in either of two ways:

Keypad – for small changes the simplest method is by means of the keypad on the front of the unit. Entry of the correct password gives access to the recorder's configuration. A simple menu structure with clear text descriptions provides an intuitive approach to the recorder set-up.

PC Configurator – the fastest way to set up **SR100A** recorders is by means of the PC Configurator software. This Windows™-based package provides a simple 'point-and-click' approach to generating a full recorder configuration off-line. The completed configuration can be printed out or saved onto disk before being downloaded to the recorder.

An interface cable is used to provide the connection between the PC's serial port and the configuration port on the recorder.

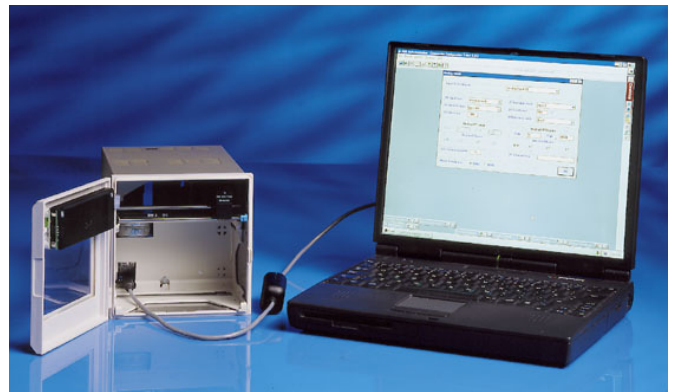

Recording

The **SR100A's** high-speed multi-point printing system updates all 6 traces in 800 ms. This system produces continuous lines on the chart for speeds of up to 500 mm/hr.

The **printing sequence** is intelligently managed by the recorder's control system to give priority to fast-changing signals or events, ensuring the most comprehensive process record is traced on the chart.

The **SR100A** supports **full text printing** to provide detailed annotation on the chart. In addition to the time, date, channel identity and chart speed, the recorder can print scales for each channel, alarm messages, totalizer values and an operator-defined batch name.

The **'Easy-view'** facility enables the user to see the latest recordings at the push of a button.



Chart Annotation

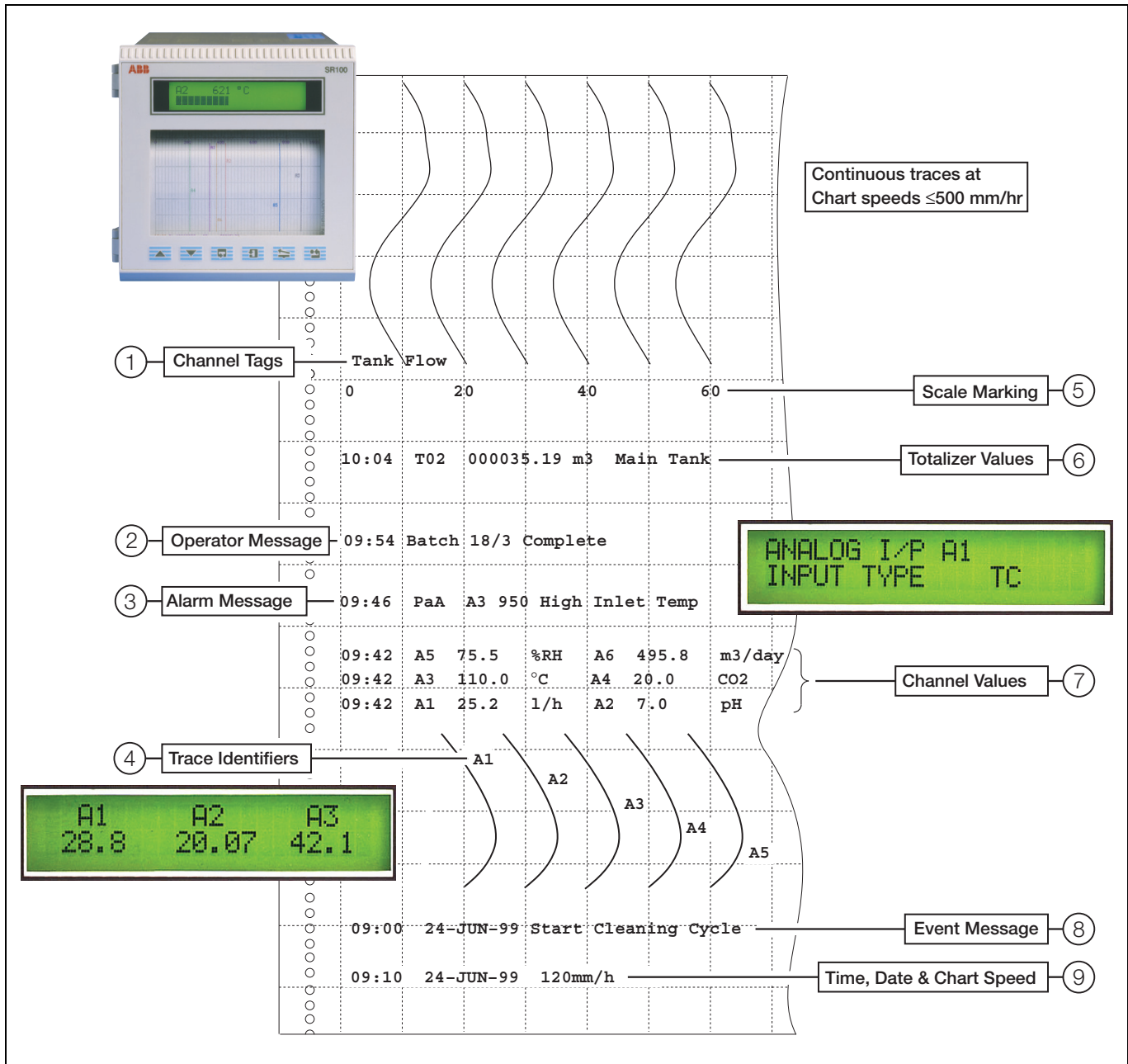

- ① **Channel Tags** – printed before chart scale to identify each channel
- ② **Operator Message** – batch identification printed on demand from a digital signal or via the front panel keys.
- ③ **Alarm Message**

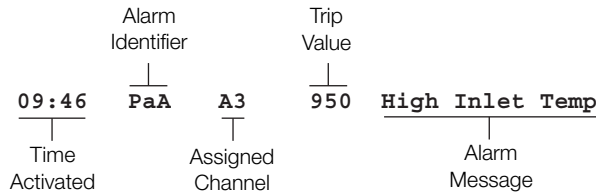

- ④ **Trace Identifiers** – one identifier per trace.
- ⑤ **Scale Marking** – one scale per trace, printed across the width of the zone, at intervals of 20 to 240 mm.
- ⑥ **Totalizer Values** – printed at programmable intervals (between 5 minutes and 24 hours).

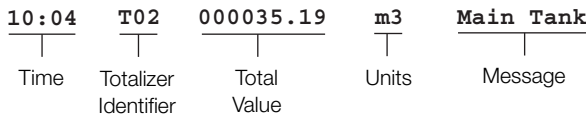

- ⑦ **Channel Values** – block of instrument channel values printed at intervals (time or digital).
- ⑧ **Event Message** – printed on demand from a digital signal or via the front panel keys.

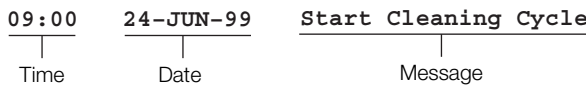

- ⑨ **Time, Date & Chart Speed** – printed on power-up and at 240 mm intervals (approx.). The time is printed every 60 mm (approx.).

Data Storage on Memory Card

The optional memory card facility provides full data logging capability and enhanced configuration security on the SR100A.

The SR100A can serve as a fully-fledged 12-channel data logger, providing a simple method of channelling analog measurements to a PC.

Up to 12 process signals or math channels can be logged to the memory card, along with associated time stamp, tag information and process alarms. Data can be directly imported to spreadsheet packages for detailed analysis or copied onto disk for later use.

Process and configuration data can be electronically stored on removable PCMCIA SRAM memory cards of up to 4 Mb capacity. Data held in the memory card is transferred to a PC via an external card reader or via a built-in PCMCIA slot. Stored information is held in DOS format files allowing direct transfer to/from a PC disk using DOS or Windows file management commands.

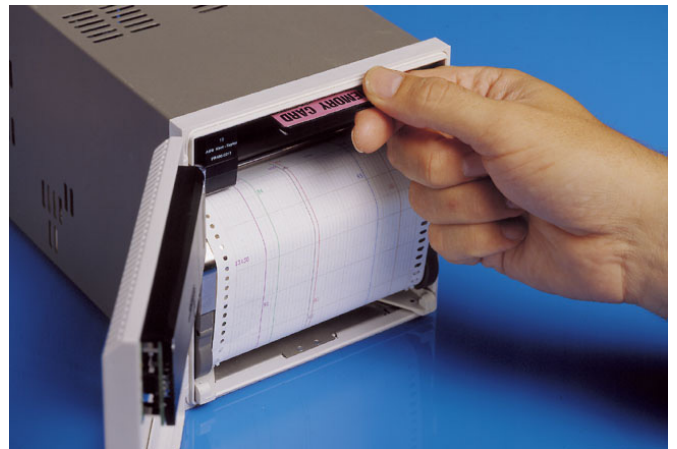

Configuration Storage

Instrument configuration can be stored via the PC software or saved on the PC memory card that can be quickly downloaded into another SR100.

MODBUS Serial Communications

The RS485 serial communications link enables the SR100A to interface with SCADA systems, PLCs or plant-wide data gathering networks.

All process information can be read over the link in real time by a host computer using MODBUS RTU communications protocol.

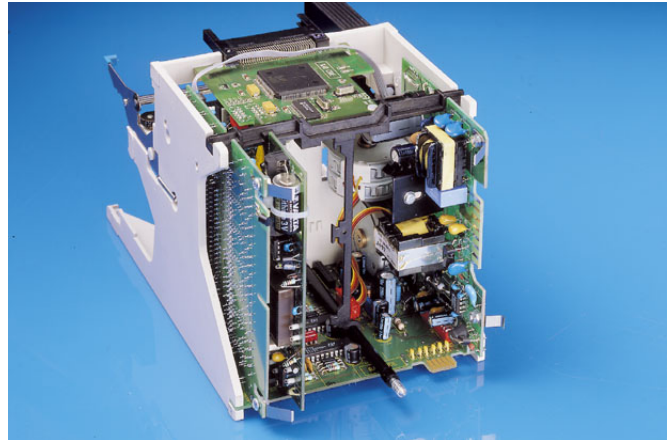
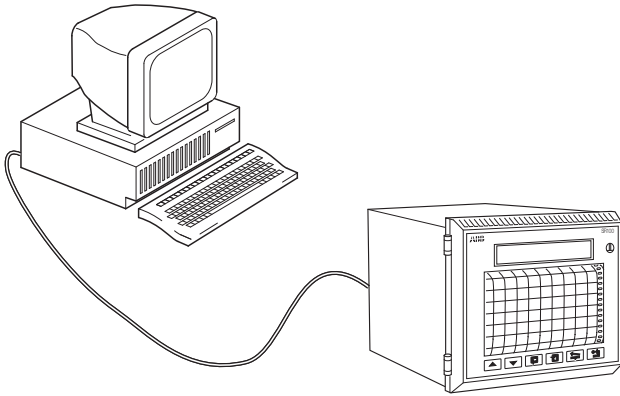

Option Modules

All recorders are complete with at least one universal input module for analog process signals, plus a transmitter power supply for up to three, 4 to 20 mA devices.

The capabilities of your recorder can be extended further by the addition of option modules. Each recorder can support 12 inputs plus up to 6 option modules.

| Type | Standard | Option |
|--------------------------|----------|--------|
| Universal inputs | 1 – 6 | – |
| Relay | 0 | 12 |
| Transmitter Power Supply | 3 | 0 |
| Serial Communications | ✘ | ✔ |
| Digital Inputs | 1 | 12 |
| Digital Outputs | 0 | 12 |

Innovative Design

Mechanical and electrical component count is minimized for improved performance and reliability.

An advanced analog/digital design ensures long term stability and allows range changes to be made without the need for recalibration.

Exceptional immunity to RF interference, electrical noise and line dropout (brown-out) conditions, together with the IP65 (NEMA 3) rated front face, ensure reliable operation – even in harsh industrial environments.

Long life, plug-in print cartridges with 25 m roll or 12 m fanfold charts (both with quick-loading cassettes) together with speeds from 1 to 1500 mm/hr ensure minimal operating costs.

Built-in Quality

The SR100A is designed, manufactured and tested to the highest quality standards, including ISO 9001, CSA and UL. We also have environmental accreditation to ISO 14001.

Applications

Mass Flow

In a number of processes, such as combustion fuel control, reactor recipe formulation and many more, there is a need to compensate for variations in temperature and pressure to enable the process to be controlled and monitored in compensated units, e.g. Mass. This applies throughout many industries such as Mining, Food, Pulp & Paper, Pharmaceutical and Chemical.

The SR100A has, as standard, up to 4 math blocks that have standard templates for Mass Flow and the ability to build your own calculations.

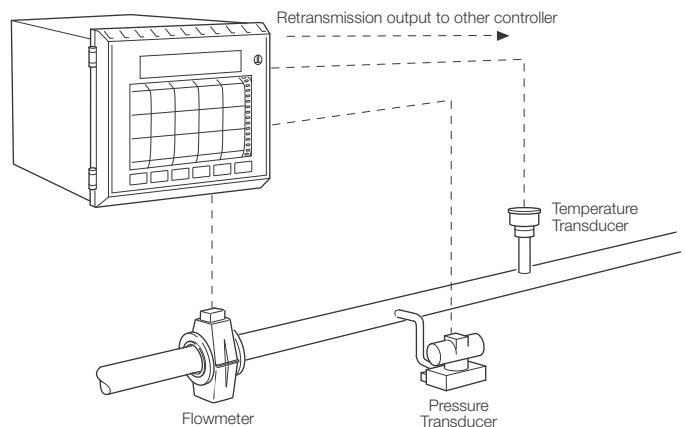

Temperature Recording

Recording of temperature is common in a wide range of industries, such as Aerospace, Car Component, Food, Chemical and Kiln / Ovens, using both direct-connected thermocouples and RTDs or 2-wire field-mounted transmitters.

The SR100A can accept direct connection to all standard thermocouples, Pt100 and 4 to 20 mA transmitters and record and datalog on up to 6 channels.

Operator messages also allow printing of configurable messages such as 'Start of Test' or 'Cycle Complete' for a clear record of the batch.

For electric ovens fit the 500 V isolator card to avoid conductance on the thermocouple that causes 'noise' on the chart.

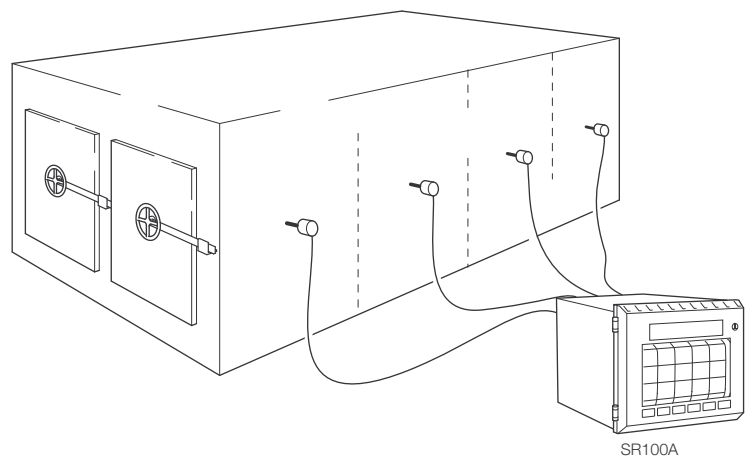

Datalogging

The ability to datalog information and transfer it to a PC in a spreadsheet format is now becoming an extremely powerful tool in a great number of industries. The ease of storing and transferring the information that this gives allows the user to undertake complex cross-correlation of trends easily on a PC.

The SR100A, as an option, has a PCMCIA port for logging up to 12 values in a DOS format, that can be directly imported into an Excel™ spreadsheet.

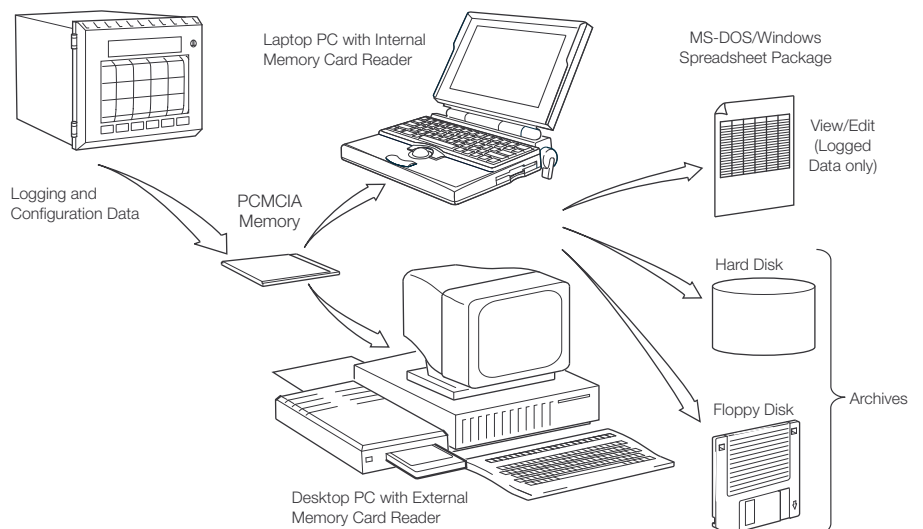

Environmental Monitoring

The monitoring and control of emissions into the atmosphere from chimneys, gas stacks etc., in particular carbon dioxide, carbon monoxide, hydrogen and Smoke Density, is becoming a statutory requirement in most countries.

The SR100A is ideal for these applications as it can trace up to 6 different input types with time and date stamps and logs a further 6 more inputs if required.

The IP65 (NEMA3) rating of the SR100A allows it to be mounted in a control room or an outdoor enclosure.

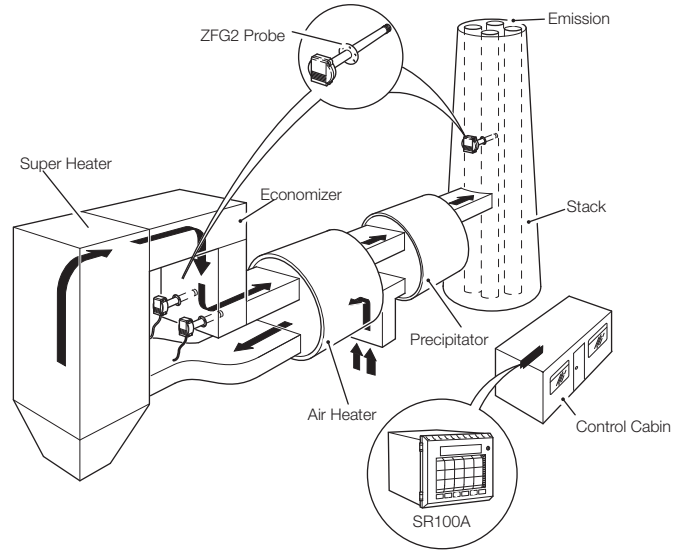

Waste Monitoring and Control

The discharge of effluent into rivers and streams is very tightly controlled and the requirement to be able to prove that the regulations have been met is extremely important. The simplest way is to use a chart recorder connected to the pH transmitter in the discharge line.

Flow rates can also be monitored with the added advantage of having multiple totalization.

One totalizer may be a continuous, non-resettable, total whereas another of the 6 available can be a weekly, resettable, total.

Totals can be printed on the chart along with the time, date and alarm conditions.

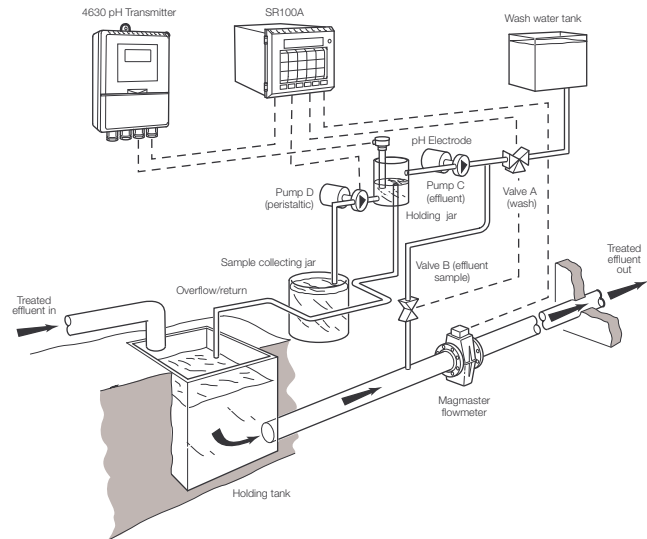

Temperature Monitoring and Alarms

The monitoring of cold stores and temperature-controlled rooms is essential in food production to ensure that the user has a record that all of the goods produced were stored at the correct temperature, ensuring that they are free from contamination.

The simplest and easiest way to do this is with the SR100A strip chart recorder, that can take up to 6 inputs from RTDs spread across a cold store or a number of food preparation areas.

At a chart speed of 20 mm/hour the unit provides recording for one month, as well as alarm functions, when fitted with relay output modules.

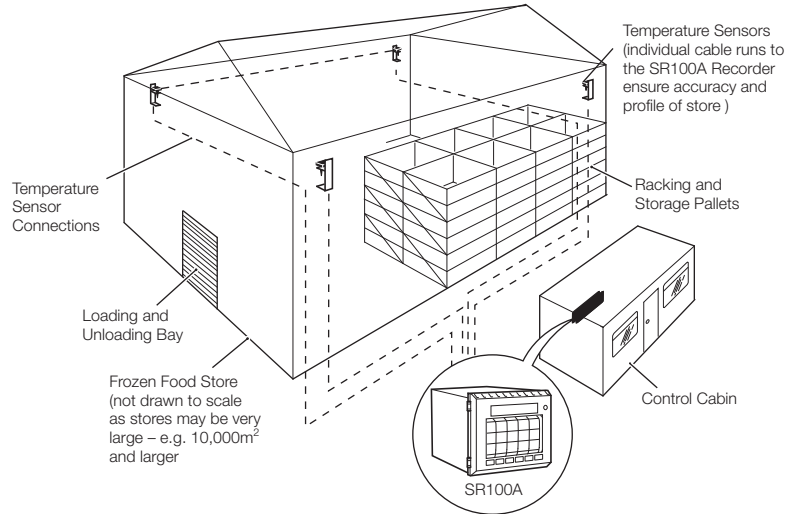

Application Function Overview



Up to **12 process alarms** can be set-up within the recorder. The alarms can be used to operate relay outputs, print messages on the chart or change the chart speed.

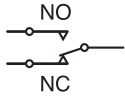

A maximum of **12 relays** can be fitted within the recorder for use as alarm outputs. A single common relay can be set up to be triggered by multiple alarms.

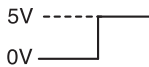

Up to **13 digital inputs** can be fitted for remote changing of chart speed, alarm acknowledgment, input to logic equations and event recording.

15480970

The SR100A includes, as standard, **6 independent flow totalizers**. These can be programmed to count up or down, with end of batch alarm if required.



Internal soft wiring of functions using **10 logic equations** minimizes installation costs and maximizes functionality.

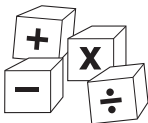

There are **4 math blocks** available, each with up to 3 inputs. Also included are preset math blocks for mass flow, %RH, max., min. and average calculations.

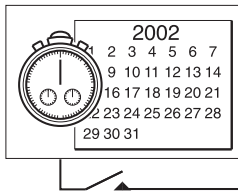

12 analog outputs can be fitted for **retransmission** of any input signal or math function result. **2 event timers** can be set to activate hourly, daily or weekly and can be used in logic equations.

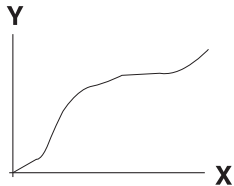

Included as standard is a **20-breakpoint** custom **linearizer** for use in non-standard thermocouples, tank level or other unusual input ranges.

Specification

Summary

- 1, 2, 3, 4, 5 or 6 traces
- 100 mm wide roll or fanfold chart
- Fully user-programmable
- IP65 (NEMA3) protection
- PC configuration

Chart

Traces

- 1 through 6 multicolor or digital data recording

Colors

- Single trace Red
- 2 traces Pen 1 = Red, Pen 2 = Green
- 3 traces Pen 1 = Red, Pen 2 = Green, Pen 3 = Blue
- 4 to 6 traces per DIN standard

Pen life

- 4 months (typical)

Chart

- 12 m fanfold or 25 m roll
- Quick-load cassette
- Cue-and-review feature standard with roll chart
- Standard chart graduation 50 divisions
 30, 40, 60, 70, 75
 divisions also available

Chart speed

- Configurable in 1 mm steps between 1 and 1500 mm/hr
- Logic or switch selectable at three configured speeds

Trace response

- 800 ms for update of 6 traces

Operation

Display

- Alphanumeric and bargraph
- 2 x 20-character long-life back-lit LCD
- 100 segment bargraph

Languages

- English, French, German user-selectable

Configuration

- User-defined via front panel, 'Memory Card' or PC Configurator

Advanced Processing Functions

Totalizers

- 6 independent, with configurable wraparound, digital / manual reset and stop / start

Text messages

- 14 configurable messages (20-character) assignable to any digital or alarm function
- 12 analog input channel tags (20-character)
- 4 math result tags (20-character)
- 6 totalizer descriptions (8-character)
- 1 operator message for batch identification (20-character)

Alarms

- 12 user-defined, system events and diagnostic alarms
- 2 real-time events

Math functions

- 4 user-configurable functions, each with 3 inputs, for evaluation of one of 8 standard arithmetic functions or for standard calculations for mass flow or %RH

Logic functions

- 10 logic equations, user-defined up to 15 elements per equation (AND, OR)



Analog Inputs

Number

- 1, 2, 3, 4, 5 or 6 Standard Analog Inputs
- 2, 3 or 6 Isolated Analog Inputs

Input sampling rate

180ms per channel

Type

Universally configurable to provide:

- Thermocouple (THC)
- Resistance thermometer (RTD)
- Millivolt
- Current
- DC voltage
- Resistance

Linearizer functions

Programmable for all inputs including: $\sqrt{\quad}$, $x^{3/2}$, $x^{5/2}$,
THC types B, E, J, K, R, S, T, L, N or Pt100*
20-point custom linearizer

Broken sensor detection

Programmable UP/DOWN scale or NONE
RTD short/open circuit detection*

Cold junction compensation

Automatic CJC incorporated as standard

Input impedance

Current 10 Ω
DC voltage 500 k Ω
mV & THC >10 M Ω

Transmitter power supply

70 mA max. powers 3 loops, fitted as standard

Input Isolation

Standard Input Module

Analog channel-to-channel 12 V (0 V with RTDs)
Input to ground 500 V DC dielectric strength
Common mode >140 dB at 50 / 60Hz with 500 Ω imbalance resistance
Series mode >60 dB at 50 / 60 Hz
Filtering 0 to 60 s 'Smart' digital filter.

Input Temperature Limits

| THC / RTD Type | °C | | | °F | | |
|------------------|------|------|-----------|------|------|-----------|
| | Min. | Max. | Min. Span | Min. | Max. | Min. Span |
| B | -18 | 1800 | 710 | 0 | 3272 | 1278 |
| E | -100 | 900 | 45 | -148 | 1652 | 81 |
| J | -100 | 900 | 50 | -148 | 1652 | 90 |
| K | -100 | 1300 | 65 | -148 | 2372 | 117 |
| L | -100 | 900 | 50 | -148 | 1652 | 90 |
| N | -200 | 1300 | 90 | -328 | 2372 | 162 |
| R & S | -18 | 1700 | 320 | 0 | 3092 | 576 |
| T | -250 | 300 | 60 | -418 | 572 | 108 |

Performance accuracy is not guaranteed below 400 °C (752 °F) for types B, R and S thermocouples.

Min. span below zero: Type T 70° C / 126 °F
Type N 105 °C / 189 °F

THC standards DIN 43710 (IEC 584)

| RTD | Min. | Max. | Min. Span | Min. | Max. | Min. Span |
|------------|------|------|-----------|------|------|-----------|
| RTD | -200 | 600 | 25 | -328 | 1112 | 45 |

3-wire platinum, 100 Ω per DIN 43760 standard (IEC751), with range of 0 to 400 Ω .

RTD standards DIN 43760 (IEC 751)

Electrical Limits

| Input Type | Min. Value | Max. Value | Min. Span |
|------------|------------|------------|-----------|
| Millivolts | -2000 | 2000 | 2.5 |
| Volts | -20 | 20 | 0.25 |
| Milliamps | -100 | 100 | 0.25 |
| Resistance | 0 | 8000 | 10 |



SR100A

100 mm Advanced Process Recorder

Accuracy

Pen

Resolution 0.2 % of span

Display

Intrinsic error for reference conditions, 20 °C

mV Inputs 0.1 % of reading $\pm 10 \mu\text{V}$
THC Inputs as mV equivalent plus linearizer error
CJC $< 0.05 \text{ }^\circ\text{C} / \text{ }^\circ\text{C}$ change in ambient
mA, V Inputs 0.2 % of reading or $\pm 2 \mu\text{A}$
RTD Inputs $< \pm 0.2 \%$ of reading or $\pm 0.5 \text{ }^\circ\text{C}$
Channel-to-Channel Offset $< 20 \mu\text{V}$ or $< 0.025 \Omega$ without using individual channel offset correction
Engineering Range -999 to $+9999$
Display Resolution for spans $> 4000 - \pm 2$ digits
for spans $< 4000 - \pm 1$ digit
Long Term Drift $< 0.01 \%$ reading, or $< \pm 5 \mu\text{V}$ annually

Physical

Size

144 x 144 x 230 mm (depth behind panel)
(5.67 x 5.67 x 9.05 in.)

Weight

3.3 kg (7.25 lbs.) approx.

Panel cut-out

138 x 138 mm (5.43 x 5.43 in.)

Case material

Stainless steel

Door material

Glass-filled polycarbonate

Window material

Polycarbonate

Electrical

Power supply

85 to 265 V 50 / 60 Hz
or 10 to 30 V DC
or 24 V AC

Power consumption

25 VA max.
20 W DC (typical)

Electrical safety

EN61010-1
CE marked instruments meet EU regulations

Electrical connections

Screw terminals

Environmental

Operating limits

5 to 50 °C (41 to 122 °F), 95 %RH non-condensing
80 %RH for chart

Temperature stability

0.02 % of reading / °C, or 2 $\mu\text{V} / \text{ }^\circ\text{C}$ whichever is greater

Protection

Front face IP65 (NEMA 3)
Rear of instrument IP20

Line interruption

< 80 ms loss, no effect
 > 80 ms loss, auto-reset and restart
IEC Part IV level 3

Electromagnetic capability

EN 50081-2
EN50082-2
CE Marked

EMC

Design & manufacturing standards

UL General Safety Approved

Emissions and Immunity

Meets requirements of IEC 61326 for an Industrial Environment

Option Modules

Up to 6 modules can be fitted from the following:

Digital module

3 digital inputs plus 3 digital outputs per module
Fully isolated, 500 V DC

| | |
|--------|--|
| Input | Volt-free contact or 5 V DC level triggered |
| Output | True TTL (15 k Ω load) 5 V or 24 V DC (20 mA per output) |

Relay output module

Three relays per module

| | |
|-------------------------|--|
| Type | single pole changeover |
| Rating | 250 V AC 5 A (non-inductive load) 250 V DC 25 W maximum |
| Total load (all relays) | 36 A max |

Serial communication module

RS422/485 protocol programmable 1200 to 9600 baud
MODBUS RTU (slave) protocol

Memory card

PCMCIA/SRAM 'credit card' type

| | |
|------------------------|--|
| Card sizes | 64 kb, 512 kb, 1 Mb, 2 Mb, 4 Mb |
| Configuration storage | DOS format files |
| Configuration capacity | 15 configurations on a 64 kb card |
| Data logging format | DOS files, spreadsheet compatible |
| Channels logged | Up to 12 (analog inputs or math) |
| Sample interval | 1 to 240 s (user-defined) |
| Card capacity | 25 days (approx.) on a 2 Mb card, for 6 channels logged every 60 s |



Overall Dimensions

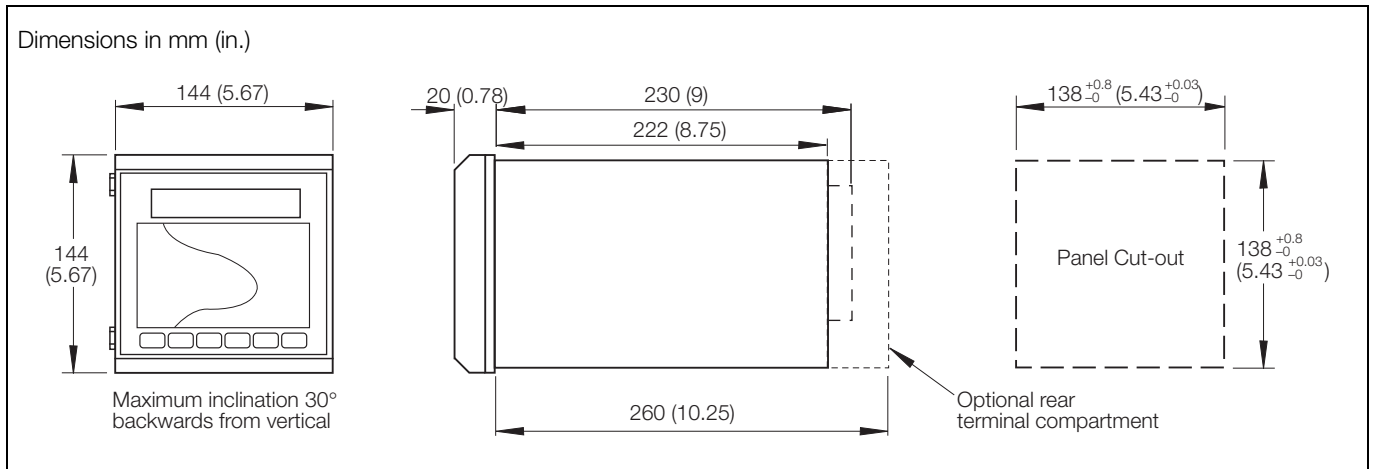

Electrical Connections

Standard Analog Input or Enhanced Analog Input

| | |
|------|--------------------------|
| A 1 | + |
| A 2 | - Analog I/P A1 |
| A 3 | 3 rd lead RTD |
| A 4 | + |
| A 5 | - Analog I/P A2 |
| A 6 | 3 rd lead RTD |
| A 7 | + |
| A 8 | - Analog I/P A3 |
| A 9 | 3 rd lead RTD |
| A 10 | + |
| A 11 | - Analog I/P A4 |
| A 12 | 3 rd lead RTD |
| A 13 | + |
| A 14 | - Analog I/P A5 |
| A 15 | 3 rd lead RTD |
| A 16 | + |
| A 17 | - Analog I/P A6 |
| A 18 | 3 rd lead RTD |
| A 19 | Logic I/P |
| A 20 | 0V |

TB1

| | | | | |
|------|------|------|------|---|
| A 1 | C 1 | E 1 | G 1 | L |
| A 2 | C 2 | E 2 | G 2 | N |
| A 3 | C 3 | E 3 | G 3 | E |
| A 4 | C 4 | E 4 | G 4 | |
| A 5 | C 5 | E 5 | G 5 | |
| A 6 | C 6 | E 6 | G 6 | |
| A 7 | C 7 | E 7 | G 7 | |
| A 8 | C 8 | E 8 | G 8 | |
| A 9 | C 9 | E 9 | G 9 | |
| A 10 | C 10 | E 10 | G 10 | |
| A 11 | B 1 | D 1 | F 1 | |
| A 12 | B 2 | D 2 | F 2 | |
| A 13 | B 3 | D 3 | F 3 | |
| A 14 | B 4 | D 4 | F 4 | |
| A 15 | B 5 | D 5 | F 5 | |
| A 16 | B 6 | D 6 | F 6 | |
| A 17 | B 7 | D 7 | F 7 | |
| A 18 | B 8 | D 8 | F 8 | |
| A 19 | B 9 | D 9 | F 9 | |
| A 20 | B 10 | D 10 | F 10 | |

TB1 TB2 TB3 TB4

AUX PWR

Alternative I/O options

| | | |
|---|-----------------------|---------------|
| L | AC Power Line | DC Power + ve |
| N | Neutral | - ve |
| E | Earth | Ground |
| | No connection | |
| | No connection | |
| | No connection | |
| + | + 24V Transmitter PSU | |
| - | - 24V Transmitter PSU | |

| Termination Number | Option Card Types | | |
|--------------------|--|----------------------------|---------------------------------------|
| | Digital 3 Digital Inputs 3 Digital Outputs | Relay Output 3 per Card | Serial Comms. Code Option F only * |
| 1 | +24 V | RL1 N/C | No connections |
| 2 | +5 V | RL1 N/O | Tx- |
| 3 | 0 V | RL1 C | Tx+ |
| 4 | O/P1 | RL2 N/C | N/C |
| 5 | O/P2 | RL2 N/O | Rx+ |
| 6 | O/P3 | RL2 C | Rx- |
| 7 | I/P1 | RL3 N/C | N/C |
| 8 | I/P2 | RL3 N/O | 0 V |
| 9 | I/P3 | RL3 C | NC |
| 10 | No connections | No connections | No connections |

* See Ordering Information

Ordering Information

| SR100A 100 mm Advanced Process Recorder | SR10 | X | A/ | X | X/ | X | X | X | X | X | X/ | X | X | X | XXXX |
|---|------|---|----|---|----|---|---|---|---|---|----|---|---|---|------|
| Number of Traces, Input Channels and Dielectric Strengths | | | | | | | | | | | | | | | |
| Single Trace | 1 | | | | | | | | | | | | | | |
| 2 traces (12 V channel-to-channel) | 2 | | | | | | | | | | | | | | |
| 3 traces (12 V channel-to-channel) | 3 | | | | | | | | | | | | | | |
| 4 traces (12 V channel-to-channel) | 4 | | | | | | | | | | | | | | |
| 5 traces (12 V channel-to-channel) | 5 | | | | | | | | | | | | | | |
| 6 traces (12 V channel-to-channel) | 6 | | | | | | | | | | | | | | |
| Build | | | | | | | | | | | | | | | |
| ABB Standard | | | | B | | | | | | | | | | | |
| UL approved | | | | U | | | | | | | | | | | |
| Special | | | | S | | | | | | | | | | | |
| Memory Card | | | | | | | | | | | | | | | |
| Not fitted | | | | | | | | | | | | | | | |
| Memory card driver fitted | | | | | | | | | | | | | | | |
| Option Module B (Note 1) | | | | | | | | | | | | | | | |
| No additional inputs or outputs | | | | | | | | | | | | | | | |
| 3 digital inputs + 3 digital outputs | | | | | | | | | | | | | | | |
| 3 relay outputs | | | | | | | | | | | | | | | |
| Option Module C (Note 1) | | | | | | | | | | | | | | | |
| No additional inputs or outputs | | | | | | | | | | | | | | | |
| 3 digital inputs + 3 digital outputs | | | | | | | | | | | | | | | |
| 3 relay outputs | | | | | | | | | | | | | | | |
| Option Module D (Note 1) | | | | | | | | | | | | | | | |
| No additional inputs or outputs | | | | | | | | | | | | | | | |
| Additional inputs: * = B or R | | | | | | | | | | | | | | | |
| Option Module E (Note 1) | | | | | | | | | | | | | | | |
| No additional inputs or outputs | | | | | | | | | | | | | | | |
| Additional inputs: * = B or R | | | | | | | | | | | | | | | |
| Option Module F (Note 1) | | | | | | | | | | | | | | | |
| No additional inputs or outputs | | | | | | | | | | | | | | | |
| Serial Communications | | | | | | | | | | | | | | | |
| Additional inputs: * = B or R | | | | | | | | | | | | | | | |
| Option Module G (Note 1) | | | | | | | | | | | | | | | |
| No additional inputs or outputs | | | | | | | | | | | | | | | |
| Additional inputs: * = B or R | | | | | | | | | | | | | | | |
| Case & Door Type | | | | | | | | | | | | | | | |
| Standard case | | | | | | | | | | | | | | | |
| Standard case + terminal cover | | | | | | | | | | | | | | | |
| Chart Drive | | | | | | | | | | | | | | | |
| Roll chart | | | | | | | | | | | | | | | |
| Fanfold chart (Note 2) | | | | | | | | | | | | | | | |
| Power Supply | | | | | | | | | | | | | | | |
| 85 to 265 V AC | | | | | | | | | | | | | | | |
| 10 to 30 V DC | | | | | | | | | | | | | | | |
| 24 V AC | | | | | | | | | | | | | | | |
| Programming / Special Features | | | | | | | | | | | | | | | |
| Configured to factory standard | | | | | | | | | | | | | | | |
| Custom configuration (customer to complete and supply SR100A custom configuration sheet – INF09/010) | | | | | | | | | | | | | | | |
| Special features | | | | | | | | | | | | | | | |
| Engineered configuration (customer to supply configuration details required) | | | | | | | | | | | | | | | |

Note 1. See page 12 for maximum number of I/O per instrument.

Note 2. Cue-and-Review and Easy View features available only with Roll Chart option.

Accessories

Memory cards to PCMCIA 68 pin standard – see price list for options available (capacity 64 k to 4 Mb)

PC Configuration Kit

C100/0700

After-sales Engineered Configuration Service

ENG/REC



SR100A

100 mm Advanced Process Recorder

Acknowledgements and Trademarks

Excel and Windows are registered trademarks of Microsoft Corporation in the United States and/or other countries.

MODBUS is a registered trademark of the Modbus-IDA organization.

